





































































## MAIN PC BOARD, CONT.

### Status LED'S

- D14** = Turned on to indicate the 12 VDC supply exceeds 2A.
- D15** = For Factory Use only.
- D16** = Turned on to indicate the 20mA TXD SRC (transmit current source) is enabled.
- D17** = Turned on to indicate 20mA is present in TXD (transmit) loop.
- D18** = Turned on to indicate the 20mA RXD SRC (receive current source) is enabled.
- D19** = Turned on to indicate 20mA is present in RXD (receive) loop.
- D21** = Blinks when the USB hub is enabled.
- D22** = Turned on to indicate the USB1 host is enabled.
- D23** = Turned on to indicate the USB2 host is enabled.
- D25** = Turned on to indicate that I/O Input 1 is active.
- D26** = Turned on to indicate that I/O Input 2 is active.
- D27** = Turned on to indicate that I/O Input 3 is active.
- D28** = Turned on to indicate that I/O Input 4 is active.
- D29** = Turned on to indicate that I/O Output 1 is active.
- D30** = Turned on to indicate that I/O Output 2 is active.
- D31** = Turned on to indicate that I/O Output 3 is active.
- D32** = Turned on to indicate that I/O Output 4 is active.



# KEYPAD FUNCTIONS

The Model 825 indicator has an interactive (Touch Screen) display, a full “QWERTY” alphanumeric keypad and four navigation keys with an interactive ENTER key. The keypad and touch screen are used to enter commands and data into the indicator. This section describes each key along with its normal function. Refer to Figure No. 20 or the actual indicator while reading this section.



**WARNING!** The membrane keypad is not to be operated with pointed objects (pencils, pens, fingernails, etc). In addition, the interactive touch screen is glass (fragile) and should not be operated with pointed objects and with excessive force. Damage to the keypad and touch screen resulting from this practice is **NOT** covered under warranty.



Figure No. 20

## ON /OFF O KEY

Pressing the **ON/OFF** key when the 825 is off will turn the indicator ON. If the indicator is already on, you must press and hold the **ON/OFF** key for about four (4) seconds to turn the indicator OFF.

**IMPORTANT!** If the auto power-on jumper has been installed (across pins 2 and 4 of P13) whenever AC power is applied to the indicator (or the AC cord plugged in), it will turn on automatically without pressing the **ON/OFF** key.

# KEYPAD FUNCTIONS, CONT.

## Navigation Keys

The Navigation Keys are used to move around and highlight the soft keys and menu selections configured by the Standard indicator and Application programs. During setup and calibration, they are used to select (highlight) the parameter to change and to advance to the next parameter, backup to the previous parameter or exit” to the previous screen.



Press the Down Arrow key to move “down” to highlight the selection.



Press the UP Arrow key to move “up” to highlight the selection.



Press the Left Arrow key to move “left” to highlight the selection.



Press the Right Arrow key to move “right” to highlight the selection.

## ENTER

The Navigation Keys **ENTER** key is used to select and perform the function of a highlighted soft key or menu selection.

Note that this key and alphanumeric **ENTER** key perform the same functions. Either key can be used when entering or changing data to signal the completion of data entry and process the data entered. During normal operations (as well as Calibration and Setup), pressing the key will retain the current settings for the parameters displayed and advance to next screen.

## Alphanumeric Keys

This section describes the alphanumeric keys along with any special functions they have. The alphanumeric keys are used to enter commands and data into the indicator during normal operations as well as during Calibration and Setup.

## QWERTY KEYS

These keys are used to enter alphabetical characters during Calibration and Setup as well as during normal operations.

## NUMERIC KEYS (1 to 9 and 0)

These keys are used to enter numeric data during the setup and calibration as well as during normal operation of the indicator. Note that they have alternate meanings. See the **SHIFT** and **FUNCT** keys

# KEYPAD FUNCTIONS, CONT.

## Alphanumeric Keys, Cont.

### SHIFT↑

Pressing this key before pressing an alphanumeric key will cause the key to output its alternate meaning.

When combined with the QWERTY (alphabetic) keys, the **SHIFT** key causes a lower case (not a capital letter) to be output. For example, pressing the **SHIFT** key then the **A** key will output a lower case "a" (not a capital letter).

Pressing the **SHIFT** key before pressing a numeric key will cause the key to output the black symbol (upper left of each key). For example, pressing the **SHIFT** key and then the **4** key will output the \$ dollar sign.

### FUNCT

Pressing the blue **FUNCT** key before pressing a numeric key will cause the key to output the blue symbol (upper right of each key). For example, pressing the **FUNCT** key and then the **7** key will output the \ (backslash) character.

### ← /ESC

This key has several functions. When entering data (either during setup and calibration or during normal operation) pressing this key will delete (backspace) the last character entered. If more than the last character is incorrect, press the ← /ESC key for each character to be deleted. Note that the indicator will ignore pressing this key if no characters have been entered.

When combined with the **SHIFT** key (pressing the **SHIFT** key and then the ← /ESC key), the display will "escape" (return or backup) to the previous screen.

### ENTER

The **ENTER** key is used when entering or changing data to signal the completion of data entry and process the data entered. During normal operations (as well as Calibration and Setup), pressing the key will retain the current settings for the parameters displayed and advance to next screen.

Note that this key and the Navigation Keys **ENTER** key perform the same functions. Either key can be used to select and perform the function of a highlighted soft key or menu selection.

### SPACE

This key is used to enter a blank space during alphanumeric data input for setup and calibration as well as during normal operations. In addition, some parameters in setup and calibration require pressing the **SPACE** key to toggle its status or to step through the available selections.

# KEYPAD FUNCTIONS, CONT.

## Standard Indicator Keys

This section describes the Standard Indicator keys (displayed on the Weight screen) along with their functions as programmed by the 825 **Standard indicator** menu selection. Refer to the actual indicator screen while reading this section.

**NOTE:** In order to use the Standard Indicator keys, the operator must press the alphanumeric letter key corresponding to the underlined letter on the key (e.g., **Z** for the Zero key) or the first letter on the key (e.g., **O** for Operator) to perform the key function. Note that the Navigation Keys can be used to select (highlight) the key and then after pressing the **ENTER** key, the key function will be performed.

## Operator

Pressing the **O** key will prompt for the input of a new operator.

1. The display will change to show the **Login** screen.
2. Enter the login and then press the ▾ Down Arrow to advance to the password prompt.
3. Enter the password and then press the **ENTER** key to proceed.
4. Otherwise, press the **ESC** key to return to the Weight screen.

## Scale

Pressing the **S** key (with multiple scales) will toggle through the available scales and, if enabled, the totalizer. Note that pressing this key with only one scale, the screen will display the message **Only one scale**.

## Date/Time

Pressing the **D** key allows the operator to change the date and time. For information on changing the date and time, refer to the Setting Date and Time section of this manual.

## TARE (Key Entry Tare)

This key allows the operator to enter a tare weight (up to the capacity of the scale). Note that the tare weight is the amount of weight to be subtracted from the gross weight to obtain the net weight.

1. Press the **T** key.
2. The display will change to show the **Set Tare** screen.
3. Using the numeric keys (use the period for the decimal point), enter the tare weight and then press the **ENTER** key.
4. The display will return to the Weight screen, showing the Gross, Tare and Net weights.

**NOTE:** The tare weight will remain until another tare weight is entered or it is cleared. Clearing the tare weight can be only performed when zero weight is on the scale.

1. With the zero weight on the scale, press the **A (TARE)** (Pushbutton Tare) key.
2. The display will return to the Weight screen, showing gross weight only.

# KEYPAD FUNCTIONS, CONT.

## Standard Indicator Keys, Cont.

### NET/GROSS

Pressing the **N** key (if in Gross mode) or the **G** key (if in Net mode) will toggle between the Gross weight and Net weight. In the Gross weight mode, the total of all weight placed on the scale since the display was zeroed is displayed. In the Net Weight mode, the Gross, Tare and Net weight is displayed.

**NOTE:** If a valid tare weight has not been entered, pressing this key will momentarily display the message:

**Cannot show net - tare zero**

The display will return to the Weight screen, showing gross weight only

### ID

This key allows the operator to enter an ID (identification) for use in printing. Note that after entering an ID, it will be displayed on the Weight screen below the **ID** key.

1. Press the **I** key.
2. The display will change to show the **set ID** screen.
3. Using the alphanumeric keys, enter up to a ten (10) character ID and then press the **ENTER** key to save it.

**NOTE:** Once an ID has been entered, it will remain until another ID is entered or it is cleared.

1. To clear an ID, first press the **I** key.
2. With the **set ID** screen displayed, press the **SPACE** key and then the **ENTER** key.
3. The display will return to the Weight screen with no ID shown below the **ID** key.

### ZERO

Pressing the **Z** key allows the operator to reset the Gross weight to zero. **IMPORTANT!** If the gross weight exceeds the zero limit for this key, pressing this key will momentarily display the message:

**CANNOT ZERO -**

The display will return to the Weight screen, showing gross weight only

Note that the zero limit may be either 4% or 100% of the scale capacity. This limit is set during setup and calibration (see the **Zero Limit** parameter).

### TARE (Pushbutton Tare)

Pressing the **A** key will act as a pushbutton tare and will store the current Gross weight as the new tare weight and will switch the display to the Net weight mode.

## KEYPAD FUNCTIONS, CONT.

### Standard Indicator Keys, Cont.

#### UNITS

Pressing the **U** key will change the weighing units to the alternate units if available. For example, with **1b** (pounds) showing, pressing this key will change the weight units to **kg** (kilograms). **IMPORTANT!** This feature must be enabled during setup and calibration (see the **Base Units** and **Conv Units** parameters).

#### PRINT

Pressing the **P** key will initiate the transmission of weight data to the ticket printer. If displaying Gross weight, the time, date and gross weight are printed. If displaying net weight, the time, date, gross, tare and net weights are printed. **IMPORTANT!** If the weight is less than zero (negative weight), pressing this key will momentarily display the message:

**Cannot print BELOW ZERO -**

The display will return to the Weight screen, showing gross weight only. Also, if the weight is unstable (motion on the scale), pressing this key will momentarily display the message:

**Cannot print MOTION -**

The display will return to the Weight screen, showing gross weight only

# KEYPAD FUNCTIONS, CONT.

## Touch Screen Keys

This section describes the Touch Screen keys along with their functions as programmed by the 825 **Application program** menu selection. Refer to Figure No. 21 below or the actual indicator touch screen while reading this section.

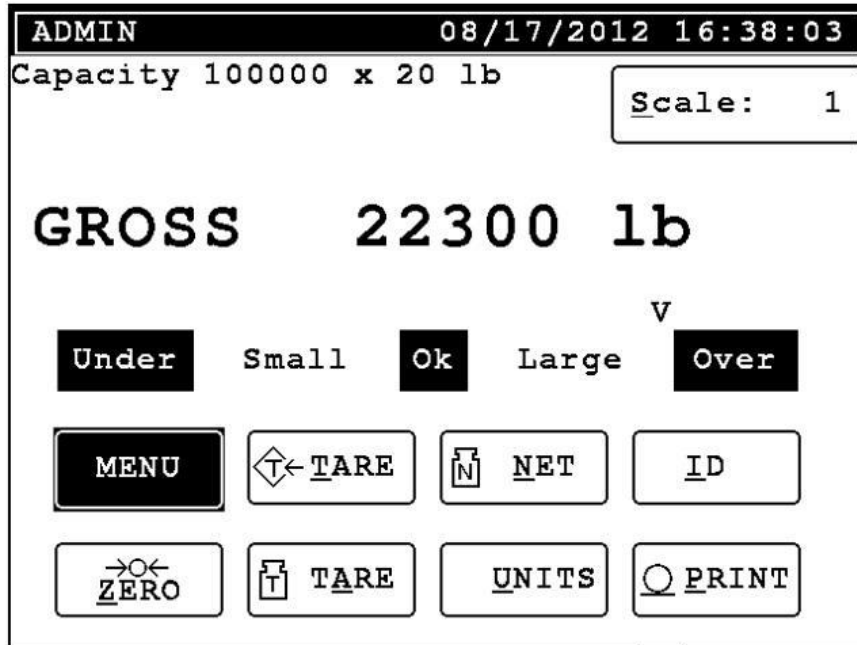

Figure No. 21

## Operator

Pressing this key will prompt for the input of a new operator.

1. The display will change to show the **LogIn** screen.
2. Enter the login and then press the  $\nabla$  Down Arrow to advance to the password prompt.
3. Enter the password and then press the **ENTER** key to proceed.
4. Otherwise, press the **ESC** key to return to the Weight screen.

## Scale

Pressing this key (with multiple scales) will toggle through the available scales and, if enabled, the totalizer. Note that pressing this key with only one scale, the screen will display the message **Only one scale**.

## Date/Time

Pressing this key allows the operator to change the date and time. For information on changing the date and time, refer to the Setting Date and Time section of this manual.

## MENU

Pressing this key allows viewing or clearing the accumulators. For information on viewing or clearing the accumulators, refer to the Accumulators section of this manual.

## KEYPAD FUNCTIONS, CONT.

### Touch Screen Keys, Cont.

#### TARE (Key Entry Tare)

Pressing this key allows the operator to enter a tare weight (up to the capacity of the scale). Note that the tare weight is the amount of weight to be subtracted from the gross weight to obtain the net weight.

1. Press the **TARE** key.
2. The display will change to show the **Set Tare** screen.
3. Using the numeric keys (use the period for the decimal point), enter the tare weight and then press the **ENTER** key.
4. The display will return to the Weight screen, showing the Gross, Tare and Net weights.

**NOTE:** The tare weight will remain until another tare weight is entered or it is cleared. Clearing the tare weight can be only performed when zero weight is on the scale.

1. With the zero weight on the scale, press the **TARE** (Pushbutton Tare) key.
2. The display will return to the Weight screen, showing gross weight only.

#### NET/GROSS

Pressing the **NET** key (if in Gross mode) or the **GROSS** key (if in Net mode) will toggle between the Gross weight and Net weight. In the Gross weight mode, the total of all weight placed on the scale since the display was zeroed is displayed. In the Net Weight mode, the Gross, Tare and Net weight is displayed.

**NOTE:** If a valid tare weight has not been entered, pressing this key will momentarily display the message:

**Cannot show net - tare zero**

The display will return to the Weight screen, showing gross weight only

#### ID

Pressing this key allows the operator to enter an ID (identification) for use in printing. Note that after entering an ID, it will be displayed on the Weight screen below the **ID** key.

1. Press the **ID** key.
2. The display will change to show the **Set ID** screen.
3. Using the alphanumeric keys, enter up to a ten (10) character ID and then press the **ENTER** key to save it.

**NOTE:** Once an ID has been entered, it will remain until another ID is entered or it is cleared.

4. To clear an ID, first press the **ID** key.
5. With the **Set ID** screen displayed, press the **SPACE** key and then the **ENTER** key.
6. The display will return to the Weight screen with no ID shown below the **ID** key.



# KEYPAD FUNCTIONS, CONT.

## Touch Screen Keys, Cont.

### ZERO

This key allows the operator to reset the Gross weight to zero. **IMPORTANT!** If the gross weight exceeds the zero limit for this key, pressing this key will momentarily display the message:

**CANNOT ZERO -**

The display will return to the Weight screen, showing gross weight only

Note that the zero limit may be either 4% or 100% of the scale capacity. This limit is set during setup and calibration (see the **Zero Limit** parameter).

### TARE (Pushbutton Tare)

Pressing this key will act as a pushbutton tare and will store the current Gross weight as the new tare weight and will switch the display to the Net weight mode.

### UNITS

Pressing this key will change the weighing units to the alternate units if available. For example, with **lb** (pounds) showing, pressing this key will change the weight units to **kg** (kilograms). **IMPORTANT!** This feature must be enabled during setup and calibration (see the **Base Units** and **Conv Units** parameters).

### PRINT

Pressing this key will initiate the transmission of weight data to the ticket printer. If displaying Gross weight, the time, date and gross weight are printed. If displaying net weight, the time, date, gross, tare and net weights are printed. **IMPORTANT!** If the weight is less than zero (negative weight), pressing this key will momentarily display the message:

**Cannot print BELOW ZERO -**

The display will return to the Weight screen, showing gross weight only. Also, if the weight is unstable (motion on the scale), pressing this key will momentarily display the message:

**Cannot print MOTION -**

The display will return to the Weight screen, showing gross weight only

# ANNUNCIATORS

The annunciators are displayed on the Weight screen to show that the 825 is in the mode corresponding to the annunciator label or that the status indicated by the label is active.

## **CENTER ZERO**

This is shown on the Weight screen to indicate that the displayed (zero) weight is within +/- 1/4 division of the center of zero.

## **GROSS**

This is shown on the Weight screen to indicate that the 825 is in the Gross weight mode.

## **NET**

This is shown on the Weight screen when the 825 is in the Net weight mode. Note that the screen will display the Gross, Tare and Net weights.

## **TARE**

This is shown on the Weight screen to indicate that a Tare weight has been stored. Note that the Gross and Net weights will be displayed also.

## **tn**

This is displayed on the Weight screen to show that the weight units are avoirdupois tons.

## **lb**

This is displayed on the Weight screen to show that the weight unit is pounds.

## **t**

This is displayed on the Weight screen to show that the weight units are tonnes (metric tons).

## **kg**

This is displayed on the Weight screen to show that the weight units are kilograms.

## SETTING THE DATE AND TIME

With the Weight screen displayed, press the **Date/Time** key on the touch screen or use the Navigation Keys to select (highlight) the **Date/Time** key and then press the **ENTER** key. The display will change to show the **Set Date/Time** screen.

### **Year :**

With the Set Date/Time screen displayed, the current setting for **Year :** will be shown. If the setting displayed is correct, press the ▽ Down Arrow to proceed to **Month :**.

Otherwise, use the numeric keys to enter the year (e.g., 2012) and then press the ▽ Down Arrow to advance to **Month :**.

### **Month :**

With the Set Date/Time screen displayed, the current setting for **Month :** will be shown. If the setting displayed is correct, press the ▽ Down Arrow to proceed to **Day :**.

Otherwise, use the numeric keys to enter the month (1 = Jan, 2 = Feb...12 = Dec) and then press the ▽ Down Arrow to advance to **Day :**.

### **Day :**

With the Set Date/Time screen displayed, the current setting for **Day :** will be shown. If the setting displayed is correct, press the ▽ Down Arrow to proceed to **Hour :**.

Otherwise, use the numeric keys to enter the day of the month (1 to 31) and then press the ▽ Down Arrow to advance to **Hour :**.

### **Hour :**

With the Set Date/Time screen displayed, the current setting for **Hour :** will be shown. If the setting displayed is correct, press the ▽ Down Arrow to proceed to **Minute :**.

Otherwise, use the numeric keys to enter the hour in 24 hour time (e.g., 3 p.m. = 15) and then press the ▽ Down Arrow to advance to **Minute :**.

### **Minute :**

With the Set Date/Time screen displayed, the current setting for **Minute :** will be shown. If the setting displayed is correct, press the ▽ Down Arrow to proceed to **Second :**.

Otherwise, use the numeric keys to enter the minutes (0 to 59 ) and then press the ▽ Down Arrow to advance to **Second :**.

### **Second :**

With the Set Date/Time screen displayed, the current setting for **Second :** will be shown. If the setting displayed is correct, press the **ENTER** key to save all of the new settings and return to the Weight screen.

Otherwise, use the numeric keys to enter the seconds (0 to 59) and then press the **ENTER** key to save all of the new settings and return to the Weight screen.

# SETUP AND CALIBRATION

Your 825 indicator has been thoroughly tested and calibrated before being shipped to you. If you received the indicator attached to a scale, calibration is not necessary. If the indicator is being connected to a scale for the first time or recalibration is necessary for other reasons, proceed as indicated.

Calibration and Setup of the indicator is accomplished entirely by the keypad. However, it may require changing the position of the calibration jumper depending on the method of sealing required by your local metrology laws.

## Calibration Jumper (J10 – CAL INHIBIT)

The calibration jumper J10 (CAL INHIBIT) is located on the edge of the 825 circuit board and can **only** be accessed by removing the rear panel of the indicator. See Figure No. 22 for the location of the calibration jumper. Refer to the table below and Figure No. 22 for the jumper settings.

When the calibration jumper is removed (off or on one pin), the word CAL will be illuminated to the right of the main screen and calibration can take place. When the calibration mode is selected, the indicator will display:

**Hardware calibration enabled**

Note that on an indicator with the jumper in this position, the Category 1 event counter security seal is used as the sealing method.

When the calibration jumper is installed (on both pins), the word CAL will NOT be illuminated to the right of the main screen and calibration is NOT permitted. With the jumper installed, the calibration screens are “read only”. When the calibration mode is selected, the indicator will display:

**Hardware calibration disabled**

Note that on an indicator with the jumper in this position and a lead-wire seal, you cannot perform the calibration unless you break the lead-wire security seal to access the calibration jumper and remove it to enable the hardware calibration. Refer to the table below:

**Table of Calibration Switch Settings**

<b>Calibration Jumper Position</b>	<b>Sealing Method Used</b>	<b>Calibration Enabled?</b>	<b>Display when calibration mode is accessed</b>
OFF	Category 1 Event Counters	Yes	<b>Hardware calibration enabled</b>
ON	Category 1 Lead-Wire Seal	No	<b>Hardware calibration disabled</b>

## SETUP AND CALIBRATION, CONT.

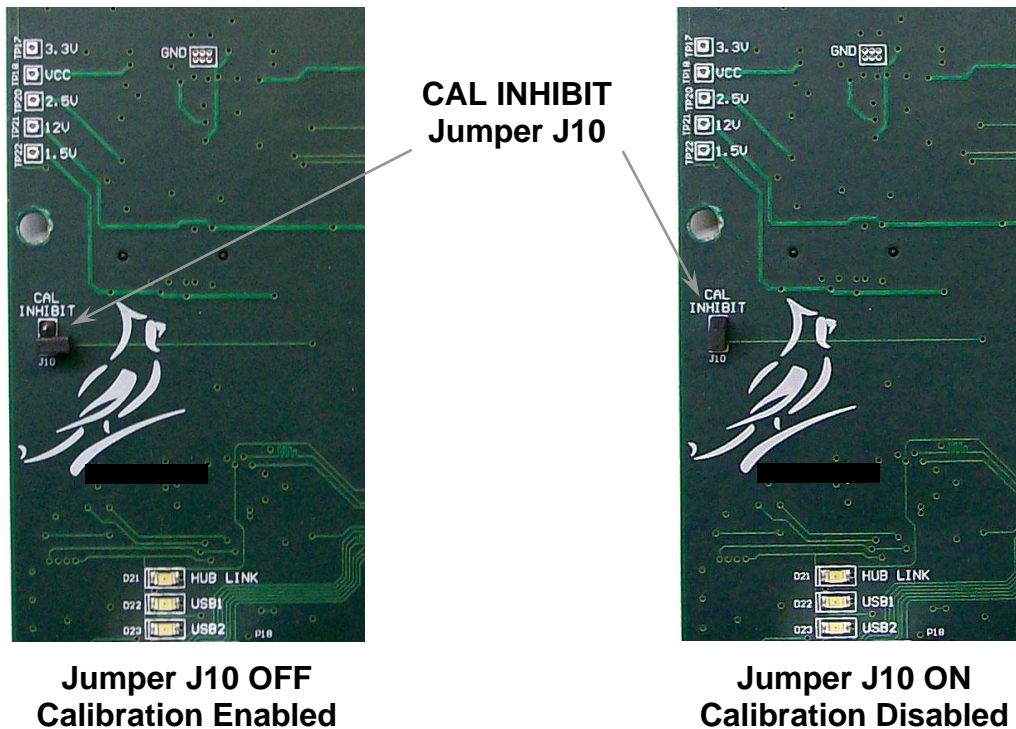

Figure No. 22



**NOTE:** With the calibration jumper installed, the display will show:

**Hardware calibration disabled**

after selecting 3. **Calibration** on the Setup Menu, and 1. **Scale 1** on the Setup Scale Number screen.

If you continue to try to perform calibration by selecting 2. **Calibrate** on the Scale 1 – Calibration Options screen, the display will show:

### **CALIBRATION SEAL**

**Calibration locked by hardware jumper  
Inside enclosure.**

**Press any key**

## SETUP AND CALIBRATION, CONT.



**WARNING!** The membrane keypad is not to be operated with pointed objects (pencils, pens, fingernails, etc). In addition, the interactive touch screen is glass and should not be operated with pointed objects and with excessive force. Damage to the keypad and touch screen resulting from this practice is **NOT** covered under warranty.

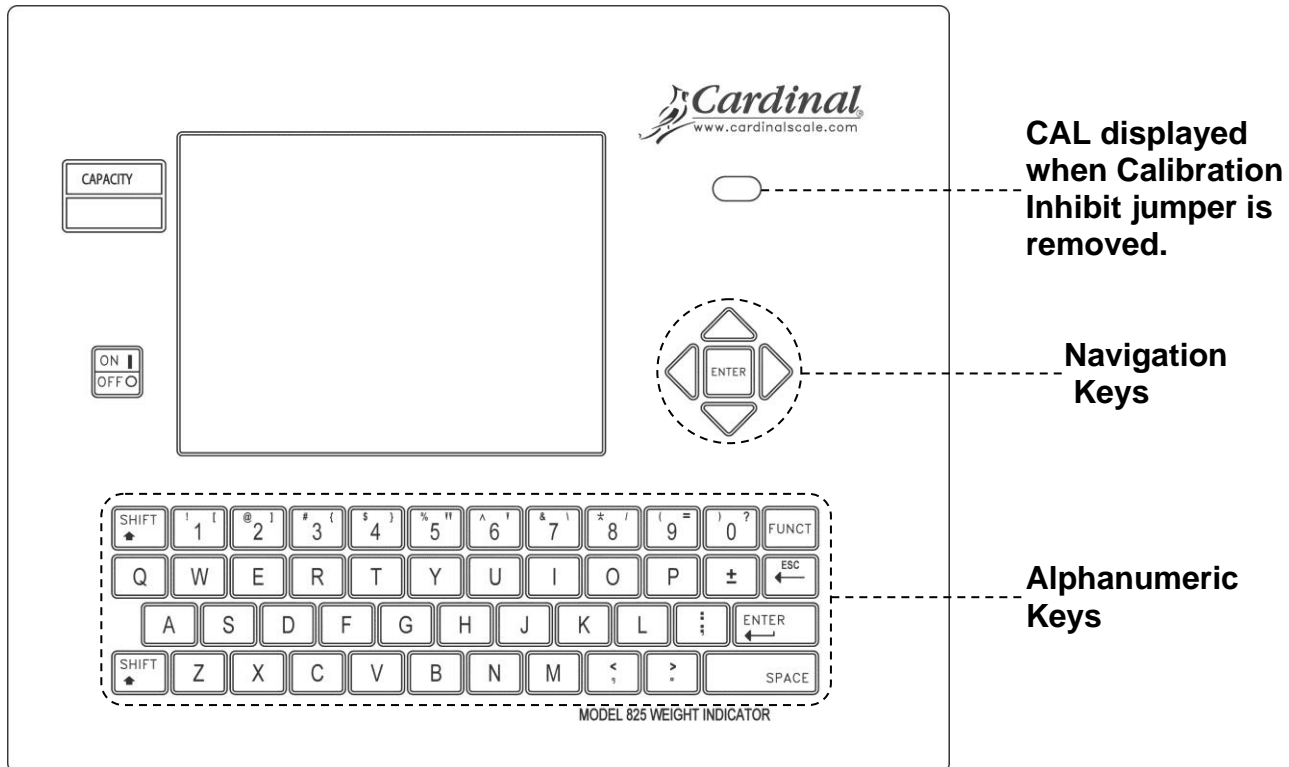

**Figure No. 23**

- Use the Navigation Keys to select (highlight) the parameter to change or press the number key corresponding to the parameter to change.
- Press the Navigation Keys  $\nabla$  Down Arrow to “advance” to the next parameter selection.
- Press the Navigation Keys  $\triangle$  UP Arrow to “backup” to the previous parameter selection.
- Press the Navigation Keys  $\triangleleft$  Left Arrow to “exit” to the previous screen.
- Pressing the alphanumeric or Navigation Keys **ENTER** key without entering a new value will retain the current setting and return to the previous or next screen.
- Use the alphanumeric keys to enter new values for parameters requiring data input.
- Some parameters require pressing the **SPACE** key to toggle its status or to step through the available selections.
- After entering (or selecting) a new value, press the Navigation Keys  $\nabla$  Down Arrow to advance to the next parameter or press the **ENTER** key to save the new setting and return to the previous or next screen.
- Press the **ESC/←** (backspace) key to delete an incorrect value or character entered.



## SETUP AND CALIBRATION, CONT.

```
Legal metrology information / Setup
Press:
1. View event counters
2. View certifications / ID information
3. Setup menu

MAC Address: 00:CF:53:29:CF:01
```

Press the Navigation Keys  $\nabla$  Down Arrow or  $\Delta$  UP Arrow to (highlight) the 3. Setup menu option and then press the **ENTER** key or press the **3** key to select the 3. Setup menu option. The display will change to show the login and password prompt screen.

```
Login 24/07/2008
Login:  _
Password:

MAC Address: 00:50:C2:88:E0:26
```

1. With the **Login** screen and prompt displayed, use the alpha-numeric keys to enter the login and then press the  $\nabla$  Down Arrow to advance to the password prompt
2. Enter the password using the alphanumeric keys and then press the **ENTER** key to proceed with Calibration and Setup.



**NOTE:** The 825 will arrive from the factory with the calibration access locked by the “login” and “password” prompts protection. The factory default login and password are “ADMIN” and “81440”.



## SETUP AND CALIBRATION, CONT.

```
Setup Menu
Press:
1. Date/Time
2. Communication
3. Calibration
4. Update software menu
5. Preferences
6. Diagnostics
7. Operators

MAC Address: 00:CF:53:29:CF:01
```

### 1. Date/Time

With the Setup Menu displayed, press the **1** key or use the Navigation Keys to select (highlight) **1. Date/Time** and then press the **ENTER** key. The display will change to show the **Set Date/Time** screen.

#### Year:

With the Set Date/Time screen displayed the current setting for the **Year:** parameter will be shown. If the setting displayed is acceptable, proceed to the next parameter.

Otherwise, use the numeric keys to enter the year (e.g., 2008) and then press the  $\nabla$  Down Arrow to advance to the next parameter or press the **ENTER** key to save the new setting and return to the previous screen.

#### Month:

With the Set Date/Time screen displayed the current setting for the **Month:** parameter will be shown. If the setting displayed is acceptable, proceed to the next parameter.

Otherwise, use the numeric keys to enter the month (1 = Jan, 2 = Feb...12 = Dec) and then press the  $\nabla$  Down Arrow to advance to the next parameter or press the **ENTER** key to save the new setting and return to the previous screen.

#### Day:

With the Set Date/Time screen displayed the current setting for the **Day:** parameter will be shown. If the setting displayed is acceptable, proceed to the next parameter.

Otherwise, use the numeric keys to enter the day of the month (1 to 31) and then press the  $\nabla$  Down Arrow to advance to the next parameter or press the **ENTER** key to save the new setting and return to the previous screen.

## SETUP AND CALIBRATION, CONT.

### **Hour :**

With the Set Date/Time screen displayed the current setting for the **Hour :** parameter will be shown. If the setting displayed is acceptable, proceed to the next parameter.

Otherwise, use the numeric keys to enter the hour in 24 hour time (e.g., 3 p.m. = 15) and then press the ▾ Down Arrow to advance to the next parameter or press the **ENTER** key to save the new setting and return to the previous screen.

### **Minute :**

With the Set Date/Time screen displayed the current setting for the **Minute :** parameter will be shown. If the setting displayed is acceptable, proceed to the next parameter.

Otherwise, use the numeric keys to enter the minutes (0 to 59 ) and then press the ▾ Down Arrow to advance to the next parameter or press the **ENTER** key to save the new setting and return to the previous screen.

### **Second :**

With the Set Date/Time screen displayed the current setting for the **Second :** parameter will be shown. If the setting displayed is acceptable, press the **ENTER** key or the Navigation Keys ◀ Left Arrow to return to the previous screen.

Otherwise, use the numeric keys to enter the seconds (0 to 59) and then press the **ENTER** key to save the new setting and return to the previous screen.

# SETUP AND CALIBRATION, CONT.

## 2. Communication

With the Setup Menu displayed, press the **2** key or use the Navigation Keys to select (highlight) **2. Communication** and then press the **ENTER** key. The display will change to show the **Communication Menu** screen.

```
Communication Menu
Press:
1. Network
2. Comm Port 1 Defaults
3. Comm Port 2 Defaults
4. Comm Port 3 Defaults
5. Comm Port 4 Defaults

MAC Address: 00:CF:53:29:CF:01
```

## 1. Network

With the Communication Menu displayed, press the **1** key or use the Navigation Keys to select (highlight) **1. Network** and then press the **ENTER** key. The display will change to show the **Setup Network** screen.

```
Setup Network
DHCP: No
Client IP: 192.168.0.100
Gateway: 0.0.0.0
Netmask: 255.255.255.0
Broadcast: 0.0.0.0
Nameserver: 0.0.0.0
Web Server: Yes Telnet: No
Weight Server: Yes
Select Yes for automatic IP assignment
from a DHCP server connected to your
network.
```

## SETUP AND CALIBRATION, CONT.

### DHCP :

With the Setup Network screen displayed the current setting for the **DHCP :** parameter will be shown. If the setting displayed is acceptable, proceed to the next parameter.

Otherwise, press the **SPACE** key to toggle its status (select YES or NO) and then press the  $\nabla$  Down Arrow to advance to the next parameter or press the **ENTER** key to save the new setting and return to the previous screen.

#### DHCP: Yes

Select Yes for automatic IP assignment from a DHCP server connected to your network

#### DHCP: No

Selecting NO allows manual entry of the Client IP, Gateway, Netmask, Broadcast, and Nameserver values



**NOTE:** If No is selected for **DHCP :**, the following additional parameters will be shown and require data to be entered. Otherwise, proceed to the **Web Server :** parameter.

### Client IP:

With No selected for DHCP: the current setting for **Client IP:** will be shown. If the setting displayed is acceptable, proceed to the next parameter.

Otherwise, use the numeric keys (and the period key) to enter the IP address for this indicator and then press the  $\nabla$  Down Arrow to advance to the next parameter or press the **ENTER** key to save the new setting and return to the previous screen. The format for the IP address is: **## . # . # . ##** (e.g., 90.1.2.68). **IMPORTANT!** No other device on the network should have this IP address.

### Gateway:

With No selected for DHCP: the current setting for **Gateway:** will be shown. If the setting displayed is acceptable, proceed to the next parameter.

Otherwise, use the numeric keys (and the period key) to enter the gateway address and then press the  $\nabla$  Down Arrow to advance to the next parameter or press the **ENTER** key to save the new setting and return to the previous screen. The format for the gateway address is: **# . # . # . #** (e.g., 0.0.0.0).

### Netmask:

With No selected for DHCP: the current setting for **Netmask:** will be shown. If the setting displayed is acceptable, proceed to the next parameter.

Otherwise, use the numeric keys (and the period key) to enter the Netmask and then press the  $\nabla$  Down Arrow to advance to the next parameter or press the **ENTER** key to save the new setting and return to the previous screen. **IMPORTANT!** The Netmask of the indicator should match the Netmask of the other computers on your network. The format for the Netmask is: **### . ### . ### . #** (e.g., 255.255.252.0).

# SETUP AND CALIBRATION, CONT.

## **Broadcast :**

With No selected for DHCP: the current setting for **Broadcast :** will be shown. If the setting displayed is acceptable, proceed to the next parameter.

Otherwise, use the numeric keys (and the period key) to enter the broadcast address and then press the ▾ Down Arrow to advance to the next parameter or press the **ENTER** key to save the new setting and return to the previous screen. The format for the gateway address is: ## . # . # . # (e.g., 90.1.2.3).

## **Nameserver :**

With No selected for DHCP: the current setting for **Nameserver :** will be shown. If the setting displayed is acceptable, proceed to the next parameter.

Otherwise, use the numeric keys (and period key) to enter the address of a name server to translate names into IP addresses and then press the ▾ Down Arrow to advance to the next parameter or press the **ENTER** key to save the new setting and return to the previous screen. The format for the Nameserver is: ## . # . # . # (e.g., 90.1.2.8).

## **Web Server :**

With the Setup Network screen displayed the current setting for the **Web Server :** parameter will be shown. If the setting displayed is acceptable, proceed to the next parameter.

Otherwise, press the **SPACE** key to toggle its status (select YES or NO) and then press the ▾ Down Arrow to advance to the next parameter or press the **ENTER** key to save the new setting and return to the previous screen.

**Web Server: Yes**

Startup Web Server is Enabled.

**Web Server: No**

Startup Web Server is Disabled.

## **Weight Server :**

With the Setup Network screen displayed the current setting for the **Weight Server :** parameter will be shown. If the setting displayed is acceptable, press the **ENTER** key or the Navigation Keys ◀ Left Arrow to return to the previous screen.

Otherwise, press the **SPACE** key to toggle its status (select YES or NO) and then press the **ENTER** key to save the new setting and return to the previous screen.

**Weight Server: Yes**

Startup Weight Server is Enabled.

**Weight Server: No**

Startup Weight Server is Disabled.

## SETUP AND CALIBRATION, CONT.

### Telnet:

With the Setup Network screen displayed the current setting for the **Telnet:** parameter will be shown. If the setting displayed is acceptable, press the **ENTER** key or the Navigation Keys ◀ Left Arrow to return to the previous screen.

Otherwise, press the **SPACE** key to toggle its status (select YES or NO) and then press the **ENTER** key to save the new setting and return to the previous screen.

#### Telnet: Yes

Telnet is Enabled. The indicator can be logged into from a telnet client program.

#### Telnet: No

Telnet is Disabled. The indicator can not be logged into from a telnet client program.



**NOTE:** The **Telnet:** parameter is for advanced users. Refer to the 825 Programmer documentation at "<http://tech.825spectrum.com>".

## SETUP AND CALIBRATION, CONT.

2. Comm Port 1 Defaults
3. Comm Port 2 Defaults
4. Comm Port 3 Defaults
5. Comm Port 4 Defaults

With the Communication Menu displayed, press the **2**, **3**, **4** or **5** key or use the Navigation Keys to select (highlight) the Com port to be configured and then press the **ENTER** key. The display will change to show the setup screen for the Com port selected.

### Baud:

With the Setup Com port screen displayed the current setting for the **Baud:** parameter will be shown. If the setting displayed is acceptable, proceed to the next parameter.

Otherwise, press the **SPACE** key to step through and select the baud rate and then press the  $\nabla$  Down Arrow to advance to the next parameter or press the **ENTER** key to save the new setting and return to the previous screen display. Supported Baud rates are:

<b>1200</b>	<b>4800</b>	<b>19200</b>	<b>57600</b>
<b>2400</b>	<b>9600</b>	<b>38400</b>	<b>115200</b>

### Parity:

With the Setup Com port 1 screen displayed, the current setting for the **Parity:** parameter will be shown. If the setting displayed is acceptable, proceed to the next parameter.

Otherwise, press the **SPACE** key to step through and select the parity and then press the  $\nabla$  Down Arrow to advance to the next parameter or press the **ENTER** key to save the new setting and return to the previous screen. Supported Parity is:

<b>None (No Parity)</b>	<b>Even</b>	<b>Odd</b>
-------------------------	-------------	------------

### Data Bits:

With the Setup Com port 1 screen displayed, the current setting for the **Data Bits:** parameter will be shown. If the setting displayed is acceptable, proceed to the next parameter.

Otherwise, use the numeric keys to enter the data bits and then press the  $\nabla$  Down Arrow to advance to the next parameter or press the **ENTER** key to save the new setting and return to the previous screen. Supported Data Bits are **7** or **8**.

### Stop Bits:

With the Setup Com port 1 screen displayed, the current setting for the **Stop Bits:** parameter will be shown. If the setting displayed is acceptable, press the **ENTER** key or the Navigation Keys  $\triangleleft$  Left Arrow to return to the previous screen.

Otherwise, use the numeric keys to enter the stop bits and then press the **ENTER** key to save the new setting and return to the previous screen. Supported Stop Bits are **1** or **2**.

## SETUP AND CALIBRATION, CONT.

### 3. Calibration

With the Setup Menu displayed, press the **3** key or use the Navigation Keys to select (highlight) **3. Calibration** and then press the **ENTER** key. The display will change to show the **Setup Scale Number** screen.

#### Scale Number:

With the Setup Scale Number screen displayed, the current setting for the **Scale Number:** will be shown. If the setting displayed is acceptable, press the **ENTER** key to proceed to the next screen or the Navigation Keys **◀** Left Arrow to return to the previous screen.

Otherwise, use the numeric keys to enter the scale number to configure and/or calibrate and then press the **ENTER** key to save the new setting and proceed to the next screen.

The display will briefly show:

```
Waiting for parameters
Waiting for multi interval
settings
```

and then change to show the **Scale 1 - Calibrations Options** screen.

```
Scale 1 - Calibration Options
Press:

1. Parameters
2. Calibrate
3. Fine span
4. Review

Hardware calibration enabled
```



# SETUP AND CALIBRATION, CONT.

## 1. Parameters

With the Scale 1 – Calibration Options screen displayed, press the **1** key or use the Navigation Keys to select (highlight) **1. Parameters**. and then press the **ENTER** key. The display will change to show the **Scale 1 – Calibration General** screen.

### Scale 1 – Calibration – General

#### Capacity:

With the Scale 1 - Calibration – General screen displayed the current setting for the **Capacity**: parameter will be shown. If the setting displayed is acceptable, proceed to the next parameter.

Otherwise, use the numeric keys to enter the maximum weight that may be weighed on the scale and then press the  $\nabla$  Down Arrow to advance to the next parameter or press the **ENTER** key to save the new setting and return to the previous screen. Note that the Capacity cannot exceed 7 digits. Allowable values are 1 through **9,999,999**.

#### Base Units:

With the Scale 1 - Calibration – General screen displayed the current setting for the **Base Units**: parameter will be shown. If the setting displayed is acceptable, proceed to the next parameter.

Otherwise, press the **SPACE** key to step through and select the Base Units and then press the  $\nabla$  Down Arrow to advance to the next parameter or press the **ENTER** key to save the new setting and return to the previous screen. Supported Base Units are:

<u>Base Units Selections</u>		
<b>lb (pounds)</b>	<b>tn (tons)</b>	<b>Custom*</b>
<b>kg (kilograms)</b>	<b>tonne (metric tons)</b>	

\* If Custom is selected for **Base Units**:, the following additional parameter will be shown (below the Base Units: parameter) and requires data to be entered. Otherwise, proceed to the **Interval**: parameter.

#### Custom Label:

With Custom selected for **Base Units**: the current setting for **Custom label**: will be shown. If the setting displayed is acceptable, proceed to the next parameter.

Otherwise, use the alpha-numeric keys to enter a new description for the Base Units Custom label (up to 4 characters, e.g., **Gal**. for Gallons) and then press the  $\nabla$  Down Arrow to advance to the next parameter or press the **ENTER** key to save the new setting and return to the previous screen.

# SETUP AND CALIBRATION, CONT.

## Interval:

With the Scale 1 - Calibration – General screen displayed the current setting for the **Interval**: parameter will be shown. If the setting displayed is acceptable, proceed to the next parameter. **NOTE!** If using multiples intervals, this is the low interval.

Otherwise, use the numeric keys to enter the interval (or minimum increment of weight reading) and then press the ▽ Down Arrow to advance to the next parameter or press the **ENTER** key to save the new setting and return to the previous screen. Allowable values are **1, 2, 5, 10, 20, 50** or **100**.

## Interval Dec:

With the Scale 1 - Calibration – General screen displayed the current setting for the **Interval Dec**: parameter will be shown. If the setting displayed is acceptable, proceed to the next parameter.

Otherwise, use the numeric keys to enter the interval decimal places and then press the ▽ Down Arrow to advance to the next parameter or press the **ENTER** key to save the new setting and return to the previous screen. Allowable values are **0** to **5**.

<b>0 = #####</b>	<b>2 = #####.##</b>	<b>4 = ###.####</b>
<b>1 = #####.#</b>	<b>3 = ####.###</b>	<b>5 = ##.#####</b>

## Conv Units:

With the Scale 1 - Calibration – General screen displayed the current setting for the **Conv Units**: parameter will be shown. If the setting displayed is acceptable, proceed to the next parameter.

Otherwise, press the **SPACE** key to step through and select the Conv Units and then press the ▽ Down Arrow to advance to the next parameter or press the **ENTER** key to save the new setting and return to the previous screen. Supported Conv Units are:

<u>Conv Units Selections</u>		
<b>lb (pounds)</b>	<b>tn (tons)</b>	<b>None</b>
<b>kg (kilograms)</b>	<b>tonne (metric tons)</b>	<b>Custom*</b>

\* If Custom is selected for **Conv Units**:, an additional parameter (below the Conv Units: parameter) and the conversion setup screen will be shown. Otherwise, proceed to the **Scale 1 - Calibration - Filtering** screen.

## Custom Label:

With Custom selected for **Conv Units**: the current setting for **Custom label**: will be shown. If the setting displayed is acceptable, press the **ENTER** key to proceed to the next screen or the Navigation Keys ◀ Left Arrow to return to the previous screen.

Otherwise, use the alphanumeric keys to enter a new description for the Conv Units Custom Label (up to 5 characters, e.g., **Litre** for Litre) and then press the **ENTER** key to save the new setting and proceed to the next screen.

# SETUP AND CALIBRATION, CONT.

## Scale 1 - Calibration - Conversion

### Conv Factor:

The Conv Factor (conversion factor) is a number that the Base Units (or Conv Units) must be multiplied by to obtain the Custom unit of measurement.

### For example:

Water weighs 8 lb per 1 Gallon.

To compute the conversion factor, you would divide 1 gallon by 8 pounds, with the result being 0.125.

Therefore, if the weight displayed were 27.65 lb, pressing the **UNITS** key would change the display to show 3.45625 ga1. ( $27.65 \times 0.125 = 3.45625$ ). The ga1. in the example stands for gallons. Refer to the Custom Label next prompt for information on entering the custom units label.

With the Scale 1 – Calibration – Conversion screen displayed the current setting for the **Conv Factor**: parameter will be shown. If the setting displayed is acceptable, proceed to the next parameter.

Otherwise, use the numeric keys to enter the conversion factor and then press the  $\nabla$  Down Arrow to advance to the next parameter or press the **ENTER** key to save the new setting and return to the previous screen. Note that the conversion factor cannot exceed 7 digits (including the decimal point).

### Sec Interval:

With the Scale 1 – Calibration – Conversion screen displayed the current setting for the **Sec Interval**: parameter will be shown. If the setting displayed is acceptable, proceed to the next parameter. **NOTE:** If using multiples intervals, this is the low interval.

Otherwise, use the numeric keys to enter the interval (or minimum increment of weight reading) and then press the  $\nabla$  Down Arrow to advance to the next parameter or press the **ENTER** key to save the new setting and return to the previous screen. Allowable values are 1, 2, 5, 10, 20, 50 or 100.

### Sec Interval Dec:

With the Scale 1 – Calibration – Conversion screen displayed the current setting for the **Sec Interval Dec**: parameter will be shown. If the setting displayed is acceptable, press the **ENTER** key to proceed to the next screen or the Navigation Keys  $\triangleleft$  Left Arrow to return to the previous screen.

Otherwise, use the numeric keys to enter the interval decimal places and then press the **ENTER** key to save the new setting and proceed to the next screen. Allowable values are 0 to 5.

0 = #####

1 = #####.#

2 = #####.##

3 = #####.###

4 = ###.####

5 = ##.#####

# SETUP AND CALIBRATION, CONT.

## Scale 1 - Calibration - Filtering

### Zero Track:

With the Scale 1 – Calibration – Filtering screen displayed the current setting for the **Zero Track:** parameter will be shown. If the setting displayed is acceptable, proceed to the next parameter.

Otherwise, press the **SPACE** key to step through and select the zero tracking range and then press the  $\nabla$  Down Arrow to advance to the next parameter or press the **ENTER** key to save the new setting and return to the previous screen. Available selections are **Off, 0.5 div., 1 div., 2 div., 3 div., 4 div., 5 div., 6 div., 7 div., 8 div., and 9 div.**

### Motion Range:

With the Scale 1 – Calibration – Filtering screen displayed the current setting for the **Motion Range:** parameter will be shown. If the setting displayed is acceptable, proceed to the next parameter.

Otherwise, use the numeric keys to enter the motion range (the number of divisions of change permitted before indicating unstable) and then press the  $\nabla$  Down Arrow to advance to the next parameter or press the **ENTER** key to save the new setting and proceed to the next screen. Allowable values are **0 to 9**. Note that entering zero (**0**) disables the motion range.

### Filtering:

With the Scale 1 – Calibration – Filtering screen displayed the current setting for the **Filtering:** parameter will be shown. If the setting displayed is acceptable, press the **ENTER** key to proceed to the next screen or the Navigation Keys  $\triangleleft$  Left Arrow to return to the previous screen.

Otherwise, press the **SPACE** key to step through and select the digital filtering and then press the **ENTER** key to save the new setting and proceed to the next screen. Allowable selections are **Off, Minimal, Moderate, and Custom.**

<b>Off</b>	Disabled (NO Filtering)
<b>Minimal</b>	Minimal Filtering (Sample Rate = 2)
<b>Moderate</b>	Moderate Filtering (Sample Rate = 1)
<b>Custom</b>	Custom Filtering (Additional Parameters Displayed)



**NOTE:** When Custom Filtering (**Custom**) has been selected, the following parameters, **TYPE:**, **Filter Break:** and **Filter Value:** will be displayed.

## SETUP AND CALIBRATION, CONT.

### Type:

With **Custom** selected for **Filtering:**, the current setting for the **Type:** parameter will be shown on the Scale 1 – Calibration – Filtering screen.

If the setting displayed is acceptable, press the **ENTER** key to proceed to the next screen or the Navigation Keys ◀ Left Arrow to return to the previous screen.

Otherwise, press the **SPACE** key to toggle between the selections and then press the **ENTER** key to save the new setting and proceed to the next screen. Allowable selections are **IIR** or **FIR**.

- IIR** (Infinite Impulse Response) – (same as previous custom filtering)
- FIR** (Finite Impulse Response) – Better for high sample rates, high speed weighing.

### Filter Break:

With **Custom** selected for **Filtering:**, the current setting for the **Filter Break:** parameter will be shown on the Scale 1 – Calibration – Filtering screen. The filter break range is a number from 1 to 64 that corresponds to the number of division changes to break out of the filtering. If the setting displayed is acceptable, press the **ENTER** key to proceed to the next screen or the Navigation Keys ◀ Left Arrow to return to the previous screen.

Otherwise, use the numeric keys to enter the value for filter break range and then press the ▾ Down Arrow to advance to the next parameter or press the **ENTER** key to save the new setting and proceed to the next screen. Allowable values are **0** to **64**.

### Filter Value:

With **Custom** selected for **Filtering:**, the current setting for the **Filter Value:** parameter will be shown on the Scale 1 – Calibration – Filtering screen. The filter value is a number from 1 to 255 that corresponds to the level of filtering with 255 being the greatest filtering and 1 the least. If the setting displayed is acceptable, proceed to the next parameter.

Otherwise, use the numeric keys to enter the value for the filter value and then press the **ENTER** key to save the new setting and proceed to the next screen. Allowable values are **0** to **255**.

# SETUP AND CALIBRATION, CONT.

## Filter Setting Recommendations

### Non-Critical Sample Rate

If the sample rate is not critical, as in static weighing, set **Filtering:** to:

- **Filtering: Off**  
(NO Filtering)
- **Filtering: Minimal**  
(Filter Value: 6, Filter Break: 12, Sample Rate: 2/Sec) or
- **Filtering: Moderate**  
(Filter Value: 6, Filter Break: 8, Sample Rate: 1/Sec).

### Critical Sample Rate

With a critical sample rate, as in a filling operation, use (**Filtering: Custom**).

1. **Sample Rate:** (1 to 200 samples/second) determination:

Set the sample rate as close as possible to produce a display graduation change for every graduation of material added to the scale.

$$\frac{\text{Material Flow Rate (lbs/second)}}{\text{Interval}} = \text{Sample Rate:}$$

$$\text{EXAMPLE: } \frac{100\text{lbs/sec}}{10\text{lbs}} = 10\text{s/s} = \text{Sample Rate:}$$

2. **Filter Value:** (0 to 255) determination: Set to desired results.

3. **Filter Break:** (1 to 64 graduations) determination:

Turn the filtering off by setting **Filtering: Off**. Operate the system as it will be normally used and, by observation, determine the number of graduations of instability that needs to be filtered out. Set the **Filter Break:** range to that value.

$$\frac{\text{Weight Change}}{\text{Interval}} = \text{Filter Break:}$$

EXAMPLE: 20,000 x 10lb capacity scale with 800lb variation in the weight display.

$$\frac{800}{10} = \text{Filter Break: } 80$$

4. If stability is unacceptable with any setting of **Filter Value:**, reduce the **Sample Rate:** and/or increase the **Filter Break:** range setting for increased filtering.

# SETUP AND CALIBRATION, CONT.

## Scale 1 - Calibration - Options

### Sample Rate:

With the Scale 1 – Calibration – Options screen displayed the current setting for the **Sample Rate:** parameter will be shown. If the setting displayed is acceptable, proceed to the next parameter.

Otherwise, use the numeric keys to enter the sample rate in samples per seconds and then press the ▽ Down Arrow to advance to the next parameter or press the **ENTER** key to save the new setting and proceed to the next screen. Allowable values are **1** to **200**.

**NOTE:** The Sample Rate: will automatically be set to a 2 when Minimal **Filtering:** has been selected, or a 1 when Moderate has been selected for **Filtering:**.

### Num Cal Pts:

Calibration of the scale can be performed using multiple calibration points to obtain a more precise weight reading over the entire span of the scale.

With the Scale 1 – Calibration – Options screen displayed the current setting for the **Num Cal Pts** parameter will be shown. If the setting displayed is acceptable, proceed to the next parameter.

Otherwise, use the numeric keys to enter the number of calibration points and then press the ▽ Down Arrow to advance to the next parameter or press the **ENTER** key to save the new setting and proceed to the next screen. Allowable values are **1** to **4**.



**NOTE:** The **Num Cal Pts** parameter is used to set the calibration points in addition to the zero (no load) weight calibration point. **DO NOT** include the zero (no load) weight calibration point when selecting the number of calibration points. For example, selecting 2 for the **Num Cal Pts** parameter, you would have a total of three calibration points, the zero (no load) weight and two calibrations points that could correspond to a mid-point weight and the test (load) weight.

## SETUP AND CALIBRATION, CONT.

### OIML:

With the Scale 1 – Calibration – Options screen displayed the current setting for the **OIML:** parameter will be shown. This parameter determines whether the indicator will be used in an application requiring an OIML Compliance. If the setting displayed is acceptable, press the **ENTER** key to proceed to the next screen or the Navigation Keys  $\leftarrow$  Left Arrow to return to the previous screen.

Otherwise, press the **SPACE** key to toggle its status (select YES or NO) and then press the **ENTER** key to save the new setting and proceed to the next screen.

#### OIML: Yes

OIML Compliance Enabled  
Manual Tare Entry (PT is displayed and printed)  
Single Interval weight displays:  
**Max** (Maximum Capacity)  
**Min** (Minimum Capacity)  
**e** (Scale Interval)

#### OIML: No

OIML Compliance Disabled  
Manual Tare Entry (MAN WT is displayed and printed)  
Single Interval weight displays:  
Scale Capacity and Interval

Selecting Yes meets International Organization of Legal Metrology (OIML) compliance. When YES is selected, serial port COM3 will be dedicated to outputting scale gross weight whenever the application program is executing. The application program cannot manipulate this output in any way. The serial port communications parameters will default to 9600 baud, 8 data bits, no parity bits and 1 stop bit. Note that the serial port communication parameters can be change in the Communication setup. The data will be sent out at a rate of 2 times per second.



# SETUP AND CALIBRATION, CONT.

## Scale 1 - Calibration - Other Options

### Zero Limit:

With the Scale 1 – Calibration – Other Options screen displayed the current setting for the **Zero Limit:** parameter will be shown. If the setting displayed is acceptable, proceed to the next parameter.

Otherwise, press the **SPACE** key to toggle its status (select YES or NO) and then press the  $\nabla$  Down Arrow to advance to the next parameter or press the **ENTER** key to save the new setting and return to the previous screen.

#### Zero Limit: Yes

Select Yes to limit push button zero and zero tracking to  $\pm 2\%$  of capacity

#### Zero Limit: No

Full capacity (no limit on push button zero and zero tracking)

### USA:

With the Scale 1 – Calibration – Other Options screen displayed the current setting for the **USA:** parameter will be shown. This parameter selects whether the indicator is used in the USA (domestic) or outside the USA (international). If the setting displayed is acceptable, proceed to the next parameter.

Otherwise, press the **SPACE** key to toggle its status (select YES or NO) and then press the  $\nabla$  Down Arrow to advance to the next parameter or press the **ENTER** key to save the new setting and return to the previous screen.

#### USA: YES

OC = 104% of scale capacity

#### USA: NO

OC = scale capacity + 9 grads

### 2nd Order Lin:

With the Scale 1 – Calibration – Other Options screen displayed the current setting for the **2nd Order Lin:** parameter will be shown. 2nd Order Linearization is a method used to correct for nonlinearity in the load cell signal. An extra term, which is proportional to the square of the load cell signal, is used in the conversion of load cell signal into a weight value. If the setting displayed is acceptable, press the **ENTER** key to proceed to the next screen or the Navigation Keys  $\triangleleft$  Left Arrow to return to the previous screen.

Otherwise, press the **SPACE** key to toggle its status (select YES or NO) and then press the **ENTER** key to save the new setting and proceed to the next screen.

#### 2nd Order Lin: Yes

2nd Order Linearization is Enable.  
The **COEFF** option will be added to Fine Span screen.

#### 2nd Order Lin: No

2nd Order Linearization is Disabled.  
Fine Span screen contains only Up, Down, Zero and Quit options.



**NOTE:** In order for 2nd Order Linearization to take effect, calibration must be performed with at least a total of three calibration points (no load and two load points with different weights). If only two calibration points (no load and load) are used, the **COEFF** option will NOT be added to the Fine Span screen.

# SETUP AND CALIBRATION, CONT.

## Scale 1 - Calibration - Multi Interval

### Intervals:

With the Scale 1 – Calibration – Multi Interval screen displayed the current setting for the **Intervals:** parameter will be shown. If the setting displayed is acceptable, proceed to the next parameter.

Otherwise, press the **SPACE** key to step through and select the Interval (number of weight ranges to use). Allowable selections are **One**, **Two**, or **Three**.

### One

Select **one** for Single Interval and then press the **ENTER** key to save the new setting and proceed to the **Calibrate Scale** screen.

After pressing the **ENTER** key, the display will briefly show:

**Setting Parameters** and then **Setting Multi-Interval**  
and then change to the **Calibrate Scale** screen.

### Two

If **Two** is selected, two (2) additional parameters will be displayed on the screen. Press the  $\nabla$  Down Arrow to advance to the;

### Low Interval Capacity:

This is the weight capacity for the low range interval. If the setting displayed is acceptable, press the  $\nabla$  Down Arrow to advance to the **Middle Interval Value:**.

Otherwise, use the numeric keys to enter the weight capacity for the low range interval and then press the  $\nabla$  Down Arrow to advance to the next parameter. Note that the value entered cannot exceed 7 digits and must be less than the overall capacity.

### Middle Interval Value:.

This is the middle range interval value. If the setting displayed is acceptable, press the **ENTER** key to save the setting and proceed to the **Calibrate Scale** screen.

Otherwise, use the numeric keys to enter the middle interval weight increment value (the value entered must be bigger than the low interval value) and then press the **ENTER** key to save the new setting.

In either case, after pressing the **ENTER** key, the display will briefly show:

**Setting Parameters** and then **Setting Multi-Interval**  
and then change to the **Calibrate Scale** screen.



**NOTE:** The error message **Invalid two interval settings** will be displayed after pressing the **ENTER** key, if incorrect values have been entered for **Low Interval Capacity:** and **Middle Interval Value:**. To change the settings, press the  $\leftarrow$  /**ESC** key to return to the **Intervals:** screen.

# SETUP AND CALIBRATION, CONT.

## Intervals:

### Three

If **Three** is selected, four (4) additional parameters will be displayed on the screen. Press the ▽ Down Arrow to advance to the;

### Low Interval Capacity:

This is the weight capacity for the low range interval. If the setting displayed is acceptable, press the ▽ Down Arrow to advance to **Middle Interval Value:**.

Otherwise, use the numeric keys to enter the weight capacity for the low range interval and then press the ▽ Down Arrow to advance to the next parameter. Note that the value entered cannot exceed 7 digits and must be less than the overall scale capacity.

### Middle Interval Value:.

This is the middle range interval value. If the setting displayed is acceptable, press the ▽ Down Arrow to advance to the **Middle Interval Capacity:**.

Otherwise, use the numeric keys to enter the middle interval weight increment value and then press the ▽ Down Arrow to advance to the next parameter. Note that the value entered must be bigger than the low interval value.

### Middle Interval Capacity:

This is the weight capacity for the middle range interval. If the setting displayed is acceptable, press the ▽ Down Arrow to advance to the **High Interval Value:**.

Otherwise, use the numeric keys to enter the weight capacity for the middle range interval and then press the ▽ Down Arrow to advance to the next parameter. Note that the value entered cannot exceed 7 digits and must be less than the overall capacity and greater than the low capacity.

### High Interval Value:

This is the middle range interval value. If the setting displayed is acceptable, press the **ENTER** key to save the setting and proceed to the **Calibrate Scale** screen.

Otherwise, use the numeric keys to enter the high interval weight increment value (the value entered must be bigger than the middle interval value) and then press the **ENTER** key to save the new setting and proceed to the **Calibrate Scale** screen.

In either case, after pressing the **ENTER** key, the display will briefly show:

**Setting Parameters** and then **Setting Multi-Interval** and then change to the **Calibrate Scale** screen.



**NOTE:** The error message **Invalid three interval settings** will be displayed after pressing the **ENTER** key, if incorrect values have been entered for **Low Interval Capacity:**, **Middle Interval Value:**, **Middle Interval Capacity:** and **High Interval Value:**. To change the settings, press the ←/ESC key to return to the **Intervals:** screen.

# SETUP AND CALIBRATION, CONT.

## Totalizer Function

The Totalizer function will sum the weights of two or more scales and make the total available to the application program. The Totalizer can be referenced as if it were another scale.

### T. Total

With the Setup Scale Number screen displayed, press the **T** key or use the Navigation Keys to select (highlight) **T. Total** and then press the **ENTER** key. The display will change to show the **Setup Scales for Totalize** screen.

Scale	Include	Capacity
1:	<b>Yes</b>	10000
2:	Yes	10000
3:	Yes	10000

### Scale Include Capacity

With the Setup Scales for Totalize screen displayed, the current setting for each **Scale** will be shown. If the setting displayed is acceptable, press the **ENTER** key to proceed to the next screen or the Navigation Keys **◀** Left Arrow to return to the previous screen.

Otherwise, press the **SPACE** key to **Include** the first scale (toggle from NO to YES) and then press the **▶** Right Arrow to advance to the **Capacity** setting. Use the numeric keys to enter the scale capacity and then press the **▽** Down Arrow to proceed to the next scale.

Repeat the above steps for each scale to be included in the Totalize and then press the **ENTER** key to save the new settings and proceed to the next parameter .

# SETUP AND CALIBRATION, CONT.

## Total – Calibration – General

### Base Units:

With the Total – Calibration – General screen displayed the current setting for the **Base Units**: parameter will be shown. If the setting displayed is acceptable, proceed to the next parameter.

Otherwise, press the **SPACE** key to select the Base Units and then press the  $\nabla$  Down Arrow to advance to the next parameter or press the **ENTER** key to save the new setting and proceed to the next screen.

### Interval:

With the Total – Calibration – General screen displayed the current setting for the **Interval**: parameter will be shown. If the setting displayed is acceptable, proceed to the next parameter. **NOTE**: If using multiples intervals, this is the low interval.

Otherwise, use the numeric keys to enter the interval (or minimum increment of weight reading) and then press the  $\nabla$  Down Arrow to advance to the next parameter or press the **ENTER** key to save the new setting and proceed to the next screen. Allowable values are **1, 2, 5, 10, 20, 50** or **100**.

### Interval Dec:

With the Total – Calibration – General screen displayed the current setting for the **Interval Dec**: parameter will be shown. If the setting displayed is acceptable, proceed to the next parameter.

Otherwise, use the numeric keys to enter the interval decimal places and then press the  $\nabla$  Down Arrow to advance to the next parameter or press the **ENTER** key to save the new setting and proceed to the next screen. Allowable values are **0** to **5**.

**0** = #####

**2** = #####.##

**4** = ###.####

**1** = #####.#

**3** = ####.###

**5** = ##.#####

### Conv Units:

With the Total – Calibration – General screen displayed the current setting for the **Conv Units**: parameter will be shown. If the setting displayed is acceptable, proceed to the next parameter.

Otherwise, press the **SPACE** key to select the Conv Units and then press the **ENTER** key to save the new setting and proceed to the next screen.

# SETUP AND CALIBRATION, CONT.

## Total - Calibration - Filtering

### Zero Track:

With the Total – Calibration – Filtering screen displayed the current setting for the **Zero Track:** parameter will be shown. If the setting displayed is acceptable, proceed to the next parameter.

Otherwise, press the **SPACE** key to step through and select the zero tracking range and then press the  $\nabla$  Down Arrow to advance to the next parameter or press the **ENTER** key to save the new setting and proceed to the next screen. Available selections are **Off, 0.5 div., 1 div., 2 div., 3 div., 4 div., 5 div., 6 div., 7 div., 8 div., and 9 div.**

### Motion Range:

With the Total – Calibration – Filtering screen displayed the current setting for the **Motion Range:** parameter will be shown. If the setting displayed is acceptable, proceed to the next parameter.

Otherwise, use the numeric keys to enter the motion range (the number of divisions of change permitted before indicating unstable) and then press the  $\nabla$  Down Arrow to advance to the next parameter or press the **ENTER** key to save the new setting and proceed to the next screen. Allowable values are **0 to 9**. Note that entering zero (**0**) disables the motion range.

### Filtering:

With the Total – Calibration – Filtering screen displayed the current setting for the **Filtering:** parameter will be shown. If the setting displayed is acceptable, press the **ENTER** key to proceed to the next screen or the Navigation Keys  $\triangleleft$  Left Arrow to return to the previous screen.

Otherwise, press the **SPACE** key to step through and select the digital filtering and then press the **ENTER** key to save the new setting and proceed to the next screen. Allowable selections are **Off, Minimal, Moderate, and Custom.**

<b>Off</b>	Disabled (NO Filtering)
<b>Minimal</b>	Minimal Filtering (Sample Rate = 2)
<b>Moderate</b>	Moderate Filtering (Sample Rate = 1)
<b>Custom</b>	Custom Filtering (Additional Parameters Displayed)



**NOTE:** When Custom Filtering (**Custom**) has been selected, the following parameters, **TYPE:**, **Filter Break:** and **Filter Value:** will be displayed.

## SETUP AND CALIBRATION, CONT.

### Type:

With **Custom** selected for **Filtering:**, the current setting for the **Type:** parameter will be shown on the Total – Calibration – Filtering screen.

If the setting displayed is acceptable, press the **ENTER** key to proceed to the next screen or the Navigation Keys ◀ Left Arrow to return to the previous screen.

Otherwise, press the **SPACE** key to toggle between the selections and then press the **ENTER** key to save the new setting and proceed to the next screen. Allowable selections are **IIR** or **FIR**.

- IIR** (Infinite Impulse Response) – (same as previous custom filtering)
- FIR** (Finite Impulse Response) – Better for high sample rates, high speed weighing.

### Filter Break:

With **Custom** selected for **Filtering:**, the current setting for the **Filter Break:** parameter will be shown on the Total – Calibration – Filtering screen. The filter break range is a number from 1 to 64 that corresponds to the number of division changes to break out of the filtering. If the setting displayed is acceptable, press the **ENTER** key to proceed to the next screen or the Navigation Keys ◀ Left Arrow to return to the previous screen.

Otherwise, use the numeric keys to enter the value for filter break range and then press the ▾ Down Arrow to advance to the next parameter or press the **ENTER** key to save the new setting and proceed to the next screen. Allowable values are **0** to **64**.

### Filter Value:

With **Custom** selected for **Filtering:**, the current setting for the **Filter Value:** parameter will be shown on the Total – Calibration – Filtering screen. The filter value is a number from 1 to 255 that corresponds to the level of filtering with 255 being the greatest filtering and 1 the least. If the setting displayed is acceptable, proceed to the next parameter.

Otherwise, use the numeric keys to enter the value for the filter value and then press the **ENTER** key to save the new setting and proceed to the next screen. Allowable values are **0** to **255**.

## SETUP AND CALIBRATION, CONT.

### Total - Calibration - Options

#### Sample Rate:

With the Total – Calibration – Options screen displayed the current setting for the **Sample Rate:** parameter will be shown. If the setting displayed is acceptable, proceed to the next parameter.

Otherwise, use the numeric keys to enter the sample rate in samples per seconds and then press the ▽ Down Arrow to advance to the next parameter or press the **ENTER** key to save the new setting and proceed to the next screen. Allowable values are **1** to **200**.

**NOTE:** The Sample Rate: will automatically be set to a 2 when Minimal **Filtering:** has been selected, or a 1 when Moderate has been selected for **Filtering:**.

#### Num Cal Pts:

Calibration of the scale can be performed using multiple calibration points to obtain a more precise weight reading over the entire span of the scale.

With the Total – Calibration – Options screen displayed the current setting for the **Num Cal Pts** parameter will be shown. If the setting displayed is acceptable, proceed to the next parameter.

Otherwise, use the numeric keys to enter the number of calibration points and then press the ▽ Down Arrow to advance to the next parameter or press the **ENTER** key to save the new setting and proceed to the next screen. Allowable values are **1** to **4**.



**NOTE:** The **Num Cal Pts** parameter is used to set the calibration points in addition to the zero (no load) weight calibration point. **DO NOT** include the zero (no load) weight calibration point when selecting the number of calibration points. For example, selecting 2 for the **Num Cal Pts** parameter, you would have a total of three calibration points, the zero (no load) weight and two calibrations points that could correspond to a mid-point weight and the test (load) weight.



## SETUP AND CALIBRATION, CONT.

### OIML:

With the Total – Calibration – Options screen displayed the current setting for the **OIML**: parameter will be shown. This parameter determines whether the indicator will be used in an application requiring an OIML Compliance. If the setting displayed is acceptable, press the **ENTER** key to proceed to the next screen or the Navigation Keys ◀ Left Arrow to return to the previous screen.

Otherwise, press the **SPACE** key to toggle its status (select YES or NO) and then press the **ENTER** key to save the new setting and proceed to the next screen.

#### OIML: Yes

OIML Compliance Enabled  
Manual Tare Entry (PT is displayed and printed)  
Single Interval weight displays:  
    **Max** (Maximum Capacity)  
    **Min** (Minimum Capacity)  
    **e** (Scale Interval)

#### OIML: No

OIML Compliance Disabled  
Manual Tare Entry (MAN WT is displayed and printed)  
Single Interval weight displays:  
    Scale Capacity and Interval

Selecting Yes meets International Organization of Legal Metrology (OIML) compliance. When YES is selected, serial port COM3 will be dedicated to outputting scale gross weight whenever the application program is executing. The application program cannot manipulate this output in any way. The serial port communications parameters will default to 9600 baud, 8 data bits, no parity bits and 1 stop bit. Note that the serial port communication parameters can be change in the Communication setup. The data will be sent out at a rate of 2 times per second.

### Total - Calibration - Other Options

#### Zero Limit:

With the Total – Calibration – Other Options screen displayed the current setting for the **Zero Limit**: parameter will be shown. If the setting displayed is acceptable, proceed to the next parameter.

Otherwise, press the **SPACE** key to toggle its status (select YES or NO) and then press the ▾ Down Arrow to advance to the next parameter or press the **ENTER** key to save the new setting and proceed to the next screen.

#### Zero Limit: Yes

Select Yes to limit push button zero and zero tracking to  $\pm 2\%$  of capacity

#### Zero Limit: No

Full capacity (no limit on push button zero and zero tracking)

## SETUP AND CALIBRATION, CONT.

### USA:

With the Total – Calibration – Other Options screen displayed the current setting for the **USA:** parameter will be shown. This parameter selects whether the indicator is used in the USA (domestic) or outside the USA (international). If the setting displayed is acceptable, proceed to the next parameter.

Otherwise, press the **SPACE** key to toggle its status (select YES or NO) and then press the  $\nabla$  Down Arrow to advance to the next parameter or press the **ENTER** key to save the new setting and proceed to the next screen.

**USA: YES**

OC = 104% of scale capacity

**USA: NO**

OC = scale capacity + 9 grads

### 2nd Order Lin:

With the Total – Calibration – Other Options screen displayed the current setting for the **2nd Order Lin:** parameter will be shown. 2nd Order Linearization is a method used to correct for nonlinearity in the load cell signal. An extra term, which is proportional to the square of the load cell signal, is used in the conversion of load cell signal into a weight value. If the setting displayed is acceptable, press the **ENTER** key to proceed to the next screen or the Navigation Keys  $\triangleleft$  Left Arrow to return to the previous screen.

Otherwise, press the **SPACE** key to toggle its status (select YES or NO) and then press the **ENTER** key to save the new setting and proceed to the next screen.

**2nd Order Lin: Yes**

2nd Order Linearization is Enable.  
The **COEFF** option will be added to  
Fine Span screen.

**2nd Order Lin: No**

2nd Order Linearization is Disabled.  
Fine Span screen contains only Up,  
Down, Zero and Quit options.



**NOTE:** In order for 2nd Order Linearization to take effect, calibration must be performed with at least a total of three calibration points (no load and two load points with different weights). If only two calibration points (no load and load) are used, the **COEFF** option will NOT be added to the Fine Span screen.

## SETUP AND CALIBRATION, CONT.

### Total - Calibration - Multi Interval

#### Intervals:

With the Total – Calibration – Multi Interval screen displayed the current setting for the **Intervals:** parameter will be shown. If the setting displayed is acceptable, press the **ENTER** key to save the setting and proceed to the next screen.

Otherwise, press the **SPACE** key to step through and select the Interval (number of weight ranges to use). Allowable selections are **One**, **Two**, or **Three**.

#### One

Select **one** for Single Interval and then press the **ENTER** key to save the new setting and proceed to the **Totalizer** screen.

After pressing the **ENTER** key, the display will briefly show:

**Setting Parameters** and then **Setting Multi-Interval** and then change to the **Totalizer** screen.

#### Two

If **Two** is selected, two (2) additional parameters will be displayed on the screen. Press the ▽ Down Arrow to advance to the;

#### Low Interval Capacity:

This is the weight capacity for the low range interval. If the setting displayed is acceptable, press the ▽ Down Arrow to advance to the **Middle Interval Value:**.

Otherwise, use the numeric keys to enter the weight capacity for the low range interval and then press the ▽ Down Arrow to advance to the next parameter. Note that the value entered cannot exceed 7 digits and must be less than the overall capacity.

#### Middle Interval Value:.

This is the middle range interval value. If the setting displayed is acceptable, press the **ENTER** key to save the setting and proceed to the **Totalizer** screen.

Otherwise, use the numeric keys to enter the middle interval weight increment value (the value entered must be bigger than the low interval value) and then press the **ENTER** key to save the new setting.

In either case, after pressing the **ENTER** key, the display will briefly show:

**Setting Parameters** and then **Setting Multi-Interval** and then change to the **Totalizer** screen.



**NOTE:** The error message **Invalid two interval settings** will be displayed after pressing the **ENTER** key, if incorrect values have been entered for **Low Interval Capacity:** and **Middle Interval Value:.** To change the settings, press the ← /**ESC** key to return to the **Intervals:** screen.

# SETUP AND CALIBRATION, CONT.

## Intervals:

### Three

If **Three** is selected, four (4) additional parameters will be displayed on the screen. Press the ▾ Down Arrow to advance to the;

### Low Interval Capacity:

This is the weight capacity for the low range interval. If the setting displayed is acceptable, press the ▾ Down Arrow to advance to **Middle Interval Value:**.

Otherwise, use the numeric keys to enter the weight capacity for the low range interval and then press the ▾ Down Arrow to advance to the next parameter. Note that the value entered cannot exceed 7 digits and must be less than the overall scale capacity.

### Middle Interval Value:.

This is the middle range interval value. If the setting displayed is acceptable, press the ▾ Down Arrow to advance to the **Middle Interval Capacity:**.

Otherwise, use the numeric keys to enter the middle interval weight increment value and then press the ▾ Down Arrow to advance to the next parameter. Note that the value entered must be bigger than the low interval value.

### Middle Interval Capacity:

This is the weight capacity for the middle range interval. If the setting displayed is acceptable, press the ▾ Down Arrow to advance to the **High Interval Value:**.

Otherwise, use the numeric keys to enter the weight capacity for the middle range interval and then press the ▾ Down Arrow to advance to the next parameter. Note that the value entered cannot exceed 7 digits and must be less than the overall capacity and greater than the low capacity.

### High Interval Value:

This is the middle range interval value. If the setting displayed is acceptable, press the **ENTER** key to save the setting and proceed to the **Totalizer** screen.

Otherwise, use the numeric keys to enter the high interval weight increment value (the value entered must be bigger than the middle interval value) and then press the **ENTER** key to save the new setting and proceed to the **Totalizer** screen.

In either case, after pressing the **ENTER** key, the display will briefly show:

**Setting Parameters** and then **Setting Multi-Interval** and then change to the **Totalizer** screen.



**NOTE:** The error message **Invalid three interval settings** will be displayed after pressing the **ENTER** key, if incorrect values have been entered for **Low Interval Capacity:**, **Middle Interval Value:**, **Middle Interval Capacity:** and **High Interval Value:**. To change the settings, press the ←/ESC key to return to the **Intervals:** screen.

## SETUP AND CALIBRATION, CONT.

### Totalizer

#### Capacity:

With the Totalizer screen displayed the current setting for the **Capacity:** parameter will be shown. If the setting displayed is acceptable, proceed to the next parameter.

Otherwise, use the numeric keys to enter the Totalizer capacity and then press the ▽ Down Arrow to advance to the next parameter or press the **ENTER** key to save the new setting and return to the Setup Scale Number screen. Note that the Capacity cannot exceed 7 digits. Allowable values are 1 through **9,999,999**.

With the Setup Scale Number screen displayed, use the numeric keys to enter the number for the scale to calibrate or press the ▽ Down Arrow and then press the **ENTER** key to select the scale to calibrate.

# SETUP AND CALIBRATION, CONT.

## Calibration Methods

The 825 has two methods to enter the calibration procedure. One method is performed after entering the calibration setup parameters. The other method is selected from the Setup Menu screen and skips entering the calibration setup parameters.

Calibration of the scale can be performed using up to four calibration points in addition to the zero (no load) weight. The number of calibration points is determined by the **Num Cal Pts** parameter. When one point is used, only screen prompts for Weight 1 and Weight 2 will be displayed. If more than one point is used, additional screen prompts for Weight 3, Weight 4 and Weight 5 will be displayed. Note that one weighing must be zero (no load) weight.

The following examples use two calibration points in addition to the zero (no load) weight. The two points could correspond to a mid-point weight and the test (load) weight.

## Calibration after Entering Scale Parameters

1. With the Calibrate Scale screen displayed, the current setting **Calibrate: NO** will be shown. If calibration is desired, press the **SPACE** key to toggle its status from **No** to **Yes** and then press the **ENTER** key to proceed with calibration. Otherwise, press the **ENTER** key to return to the **Scale 1 - Calibration Options** screen.
2. The display will change to show the **Scale 1 - Calibration Weight 1** screen.
3. If this is the zero weight (no load), press the **0** key and then press the **ENTER** key. Otherwise, place the weights on the scale and then using the numeric keys, enter the current weight on the scale and then press the **ENTER** key.
4. The display will show the percentage of completion and a dashed line proceeding from left to right for this step. When this step has been completed, the display will change to show the **Scale 1 - Calibration Weight 2** screen.
5. If this is the zero weight (no load), press the **0** key and then press the **ENTER** key. Otherwise, place the weights on the scale and then using the numeric keys, enter the current weight on the scale and then press the **ENTER** key.
6. The display will show the percentage of completion and a dashed line proceeding from left to right for this step. When this step has been completed, the display will change to change to show the **Scale 1 - Calibration Weight 3** screen.
7. If this is the zero weight (no load), press the **0** key and then press the **ENTER** key. Otherwise, place the weights on the scale and then using the numeric keys, enter the current weight on the scale and then press the **ENTER** key.
8. The display will show the percentage of completion and a dashed line proceeding from left to right for this step. When this step has been completed, the display will change to show the **Scale 1 - Fine Span** screen. **NOTE:** If Span Adjustment is required, proceed to the FINE SPAN ADJUSTMENT.

# SETUP AND CALIBRATION, CONT.

## Calibration from the Setup Menu

1. From the Startup screen, press the **3** key or use the Navigation Keys to select (highlight) **3. Legal metrology information / setup** option and then press the **ENTER** key.
2. From the Legal metrology information / Setup screen, press the **3** key or use the Navigation Keys to select (highlight) **3. Setup menu** and then press the **ENTER** key.
3. Enter the Login and Password if the **Login** screen is displayed.
4. With the Setup Menu screen displayed, press the **3** key or use the Navigation Keys to select (highlight) **3. Calibration** and then press the **ENTER** key.
5. With the Setup Scale Number screen displayed, verify the correct scale number is shown and then press the **ENTER** key. Otherwise, use the numeric keys to enter the scale number and then press the **ENTER** key.
6. The display will change to show the **Scale 1 - Calibration Options** screen, press the **2** key or use the Navigation Keys to select (highlight) **2. Calibration** and then press the **ENTER** key.
7. The display will change to show the **Scale 1 - Calibration Weight 1** screen.
8. If this is the zero weight (no load), press the **0** key and then press the **ENTER** key. Otherwise, place the weights on the scale and then using the numeric keys, enter the current weight on the scale and then press the **ENTER** key.
9. The display will show the percentage of completion and a dashed line proceeding from left to right for this step. When this step has been completed, the display will change to show the **Scale 1 - Calibration Weight 2** screen.
10. If this is the zero weight (no load), press the **0** key and then press the **ENTER** key. Otherwise, place the weights on the scale and then using the numeric keys, enter the current weight on the scale and then press the **ENTER** key.
11. The display will show the percentage of completion and a dashed line proceeding from left to right for this step. When this step has been completed, the display will change to change to show the **Scale 1 - Calibration Weight 3** screen.
12. If this is the zero weight (no load), press the **0** key and then press the **ENTER** key. Otherwise, place the weights on the scale and then using the numeric keys, enter the current weight on the scale and then press the **ENTER** key.
13. The display will show the percentage of completion and a dashed line proceeding from left to right for this step. When this step has been completed, the display will change to show the **Scale 1 - Fine Span** screen. **NOTE:** If Span Adjustment is required, proceed to the FINE SPAN ADJUSTMENT.

## SETUP AND CALIBRATION, CONT.

### Scale 1 - Fine Span

If Fine Span adjustment is desired, with the **Scale 1 - Fine Span** screen displayed, place a calibrated test weight on the scale.

Use the Navigation Keys to select (highlight) the Fine Span adjustment option and then press the **ENTER** key to perform the function or;

Press the **U** key (U. Up) to increase displayed weight.

Press the **D** key (D. Down) to decrease the displayed weight,

Press the **Z** key (Z. Zero) to zero the scale.

Press the **Q** key (Q. Quit) to save the current settings and Quit.

The display will return to the **Scale 1 - Calibration Options** screen.

If **2nd Order Linearization** was enabled and the **Num Cal Pts** parameter is set for 2 or more, then a **COEFF** option will be added to the Fine Span screen. This option is used to make adjustments to the displayed weight after linearization testing has shown an error in a specific range of weight.

Press the **C** key (C. Coeff) or use the Navigation Keys to select (highlight) the **C. Coeff** option and then press the **ENTER** key to proceed to the **Coefficient** screen.

#### **Linear Coefficient:**

The Linear Coefficient is applied to the load cell signal to calculate weight. If the current setting displayed for this coefficient is acceptable, press the  $\nabla$  Down Arrow to advance to the **2nd Order Coeff:** parameter.

Otherwise, use the numeric keys to enter a new Linear Coefficient and then press the  $\nabla$  Down Arrow to advance to the next parameter.

#### **2nd Order Coeff:**

This coefficient is applied to the square of the load cell signal to calculate weight. If the current 2nd Order Coeff setting displayed is acceptable, press the  $\nabla$  Down Arrow to advance to the **Tweak low weight:** parameter.

Otherwise, use the numeric keys to enter a new 2nd Order Coeff and then press the  $\nabla$  Down Arrow to advance to the next parameter.



**WARNING! Changing the Linear Coefficient or the 2nd Order Coeff will affect the indicator's ability to display the proper weight. Please consult the factory before making any changes.**



## SETUP AND CALIBRATION, CONT.

### **Tweak low weight:**

This is the low end of the range of weight that requires adjusting. For example, if after performing linearization testing, the displayed weight is 5 lbs low between 10,000 lbs and 15,000 lbs, the value for the tweak low weight is 10000.

If the setting displayed is acceptable, press the ▽ Down Arrow to advance to the **Tweak high weight:** parameter.

Otherwise, use the numeric keys to enter the tweak low weight and then press the ▽ Down Arrow to advance to the next parameter.

### **Tweak high weight:**

This is the high end of the range of weight that requires adjusting. Using the example above, the value for the tweak high weight is 15000.

If the setting displayed is acceptable, press the ▽ Down Arrow to advance to the **Tweak weight:** parameter.

Otherwise, use the numeric keys to enter the tweak high weight and then press the ▽ Down Arrow to advance to the next parameter.

### **Tweak weight:**

This is the amount of weight that needs to be added (or subtracted) from the range of weight to bring the displayed weight into tolerance. Again, using the example above, the Tweak Weight would be 5.

If the setting displayed is acceptable, press the **ENTER** key to return to the **Scale 1 - Fine Span** screen.

Otherwise, use the numeric keys to enter a new tweak weight and then press the **ENTER** key to return to the **Scale 1 - Fine Span** screen.

# PREFERENCES

1. Press the **ON/OFF** key to turn on the 825. The display will perform a short self-test and then change to the Startup screen showing the software versions and status of the option cards.
2. Press the Navigation Keys  $\nabla$  Down Arrow to “advance” to (highlight) the **Legal metrology information / Setup menu** option and then press the **ENTER** key or press the **3** key to select the **Legal metrology information / Setup** option. The display will change to show the **Legal metrology information / Setup** screen.



**NOTE:** If the Login and Password protection feature has been enable, the **Login** screen will be displayed instead of the **Legal metrology information / Setup** screen. Enter the login and then press the  $\nabla$  Down Arrow to advance to the password prompt. Enter the password and then press the **ENTER** key to proceed to the **Legal metrology information / Setup**.

3. From the **Legal metrology information / Setup** screen, press the **3** key or use the Navigation Keys to select (highlight) **3. Setup menu** and then press the **ENTER** key.
4. With the **Setup Menu** displayed, press the **5** key or use the Navigation Keys to select (highlight) **5. Preferences** and then press the **ENTER** key. The display will change to show the **Preferences Menu** screen.

```
Preferences Menu
Press:
1. Date/Time
2. Color Scheme
3. Color Palette
4. LCD Settings
5. Sound Settings

MAC Address: 00:50:C2:88:E0:26
```

## 1. Date/Time

With the **Preferences Menu** displayed, press the **1** key or use the Navigation Keys to select (highlight) **1. Date/Time** and then press the **ENTER** key. The display will change to show the **Setup Preferences** screen for the Date and Time.

## PREFERENCES, CONT.

### Date Format:

With the Setup preferences screen displayed the current setting for the **Date Format:** parameter will be shown. If the setting displayed is acceptable, proceed to the next parameter.

Otherwise, press the **SPACE** key to step through and select the date format and then press the **▽ Down Arrow** to advance to the next parameter or press the **ENTER** key to save the new setting and return to the previous screen. The formats available are:

**Day Month Year**

**Year Month Day**

**Month Day Year**

### Date Separator:

With the Setup preferences screen displayed the current setting for the **Date Separator:** parameter will be shown. If the setting displayed is acceptable, proceed to the next parameter.

Otherwise, use the alphanumeric keys to enter a new character for the date separator and then press the **▽ Down Arrow** to advance to the next parameter or press the **ENTER** key to save the new setting and return to the previous screen.

### Time Format:

With the Setup preferences screen displayed the current setting for the **Time Format:** parameter will be shown. If the setting displayed is acceptable, proceed to the next parameter.

Otherwise, press the **SPACE** key to toggle between the 12 Hour or 24 Hour time format and then press the **▽ Down Arrow** to advance to the next parameter or press the **ENTER** key to save the new setting and return to the previous screen.

### Time Separator:

With the Setup preferences screen displayed the current setting for the **Time Separator:** parameter will be shown. If the setting displayed is acceptable, proceed to the next parameter.

Otherwise, use the alphanumeric keys to enter a new character for the time separator and then press the **▽ Down Arrow** to advance to the next parameter or press the **ENTER** key to save the new setting and return to the previous screen.

### a.m. :

With the Setup preferences screen displayed the current setting for the **a.m. :** parameter will be shown. If the setting displayed is acceptable, proceed to the next parameter.

Otherwise, use the alphanumeric keys to specify the text for a.m. time and then press the **▽ Down Arrow** to advance to the next parameter or press the **ENTER** key to save the new setting and return to the previous screen.

## PREFERENCES, CONT.

### **p.m. :**

With the Setup preferences screen displayed the current setting for the **p.m. :** parameter will be shown. If the setting displayed is acceptable, press the **ENTER** key or the Navigation Keys  $\triangleleft$  Left Arrow to return to the previous screen.

Otherwise, use the alphanumeric keys to specify the text for p.m. time and then press the **ENTER** key to save the new setting and return to the previous screen.

# PREFERENCES

## Sound Settings

The sound settings parameters allow you to customize the beep that occurs each time a key is pressed. The duration of the beep as well as the note and octave produced can be set or the key beep can be turned off.

### 5. Sound Settings

With the Preferences Menu displayed, press the **5** key or use the Navigation Keys to select (highlight) **5. Sound Settings** and then press the **ENTER** key. The display will change to show the **Setup Sound Preferences** screen.

#### Key sound time:

With the Setup Sound Preferences screen displayed, the current setting for the **Key sound time:** parameter will be shown. This is the length of time the beep sounds each time a key is pressed. The key sound time (key beep duration) can be from no beep or off to a full one second. If the setting displayed is acceptable, proceed to the next parameter.

Otherwise, press the **SPACE** key to step through and select the key sound time and then press the  $\nabla$  Down Arrow to advance to the next parameter or press the **ENTER** key to save the new setting. The available selections are **None** (no key beep), **31.25ms**, **62.5ms**, **125ms**, **250ms**, **500ms** and **1sec**. Note that **ms** = millisecond (1/1000 of a second).

#### Key sound freq:

With the Setup Sound Preferences screen displayed, the current setting for the **Key sound freq:** parameter will be shown. This is the note and octave of the key beep sound. If the setting displayed is acceptable, press the **ENTER** key or the Navigation Keys  $\triangleleft$  Left Arrow to return to the previous screen.

Otherwise, press the **SPACE** key to step through and select the keynote and octave and then press the **ENTER** key to save the new setting and return to the previous screen. The available selections are **None** (no key beep), **31.25ms**, **62.5ms**, **125ms**, **250ms**, **500ms** and **1sec**. Note that **ms** = millisecond or 1/1000 of a second. The available selections are **C5**, **D5**, **E5**, **F5**, **G5**, **A5**, **B5**, **C6**, **E6**, **G6**, **A6**, **C7**, **D7**, and **E7**.

### After Pressing the ENTER key

After pressing the **ENTER** key (at either parameter), the display will change to show:

**Power off and on for changes  
to take effect.**

Press and hold (about 4 seconds) the **ON/OFF** key to turn off the indicator. Wait a few seconds and then press it again to turn the indicator back ON. The sound settings have been saved and are now effective.

# OPERATORS

The Model 825 supports up to eight operators. One operator, the Administrator has full access to all functions and features of the 825. The remaining seven can be configured to allow or prevent access to various functions and features. Note that only the login name and password can be changed for the Administrator operator.

1. Press the **ON/OFF** key to apply power to the 825. The display will perform a short self-test and then change to the Startup screen showing the software versions and status of the option cards.
2. Press the Navigation Keys  $\nabla$  Down Arrow to “advance” to (highlight) the **Legal metrology information / Setup** option and then press the **ENTER** key or press the **3** key to select the **Legal metrology information / Setup** option. The display will change to show the **Legal metrology information / Setup** screen.



**NOTE:** If the Login and Password protection feature has been enable, the **Login** screen will be displayed instead of the **Legal metrology information / Setup** screen. Enter the login (ADMIN) and then press the  $\nabla$  Down Arrow to advance to the password prompt. Enter the password and then press the **ENTER** key to proceed to the Legal metrology information / Setup.

3. From the Legal metrology information / Setup screen, press the **3** key or use the Navigation Keys to select (highlight) **3. Setup menu** and then press the **ENTER** key.
4. With the Setup Menu displayed, press the **7** key or use the Navigation Keys to select (highlight) **7. Operators** and then press the **ENTER** key. The display will change to show the **Setup Operators** screen.

```
Setup Operators
Press:

1. List Operators
2. Add Operator
3. Edit Operator
4. Delete Operator
5. Set Default Operator

MAC Address: 00:50:C2:88:E0:26
```

# OPERATORS, CONT.

## 1. List Operators

1. With the Setup Operators screen displayed, press the **1** key or use the Navigation Keys to select (highlight) **1. List Operators** and then press the **ENTER** key.
2. The display will change to show the **Operator List** screen for the current programmed operators.
3. After viewing the list, press any key to return to the **Setup Operators** screen.

## 2. Add Operator

When you add an operator to the indicator, you are allowing that individual to have access to functions and features of the indicator.

With the Setup Operators screen displayed, press the **2** key or use the Navigation Keys to select (highlight) **2. Add Operator** and then press the **ENTER** key. The display will change to show the **Add Operator** screen.

Add Operator			
Login:	_	Config:	Yes
Password:		File Mgr:	Yes
Zero:	Yes	Custom 1:	No
Keybd tare:	Yes	Custom 2:	No
Push tare:	Yes	Custom 3:	No
Print:	Yes	Custom 4:	No
Units:	Yes	Custom 5:	No
Sel Scale:	Yes	Custom 6:	No
Date/time:	Yes	Custom 7:	No
Enter login ID			

### Login:

Use the alphanumeric keys to enter a login (name) for the operator (up to 8 characters, e.g., CARDINAL) and then press the  $\nabla$  Down Arrow to advance to the next parameter.

### Password:

Use the alphanumeric keys to enter a password for the operator (up to 8 characters) and then press the  $\nabla$  Down Arrow to advance to the next parameter. Note that if a password is not required (or desired), it can be left blank. **IMPORTANT!** The password will be visible while entering it. During operations, a row of asterisks will be shown when entering the password.



**NOTE:** To change the displayed setting on the following parameters, press the **SPACE** key to toggle between Yes and No or press the **Y** key for Yes or the **N** key for No.

## OPERATORS, CONT.

### **Zero:**

With the Add Operator screen displayed, the current setting for **zero:** will be shown. If the operator is allowed to zero the scale, press the ▽ Down Arrow to proceed to the next parameter.

Otherwise, press the **SPACE** key (or the **Y** or **N** key) to toggle between the **Yes** and **No** and then press the ▽ Down Arrow to advance to the next parameter.

### **Keybd tare:**

With the Add Operator screen displayed, the current setting for **Keybd tare:** will be shown. If the operator is allowed to manually enter a tare weight, press the ▽ Down Arrow to proceed to the next parameter.

Otherwise, press the **SPACE** key (or the **Y** or **N** key) to toggle between the **Yes** and **No** and then press the ▽ Down Arrow to advance to the next parameter.

### **Push tare:**

With the Add Operator screen displayed, the current setting for **Push tare:** will be shown. If the operator is allowed to use the Push Button tare function to enter a tare weight, press the ▽ Down Arrow to proceed to the next parameter.

Otherwise, press the **SPACE** key (or the **Y** or **N** key) to toggle between the **Yes** and **No** and then press the ▽ Down Arrow to advance to the next parameter.

### **Print:**

With the Add Operator screen displayed, the current setting for **Print:** will be shown. If the operator is allowed to print a ticket, press the ▽ Down Arrow to proceed to the next parameter.

Otherwise, press the **SPACE** key (or the **Y** or **N** key) to toggle between the **Yes** and **No** and then press the ▽ Down Arrow to advance to the next parameter.

### **Units:**

With the Add Operator screen displayed, the current setting for **Units:** will be shown. If the operator is allowed to select the alternate weighing units, press the ▽ Down Arrow to proceed to the next parameter.

Otherwise, press the **SPACE** key (or the **Y** or **N** key) to toggle between the **Yes** and **No** and then press the ▽ Down Arrow to advance to the next parameter.

### **Sel Scale:**

With the Add Operator screen displayed, the current setting for **Sel Scale:** will be shown. In a multiple scale operation, if the operator is allowed to choose between available scales, press the ▽ Down Arrow to proceed to the next parameter.

Otherwise, press the **SPACE** key (or the **Y** or **N** key) to toggle between the **Yes** and **No** and then press the ▽ Down Arrow to advance to the next parameter.



## OPERATORS, CONT.

### **Date/Time:**

With the Add Operator screen displayed, the current setting for **Date/Time:** will be shown. If the operator is allowed to change the date and time, press the **ENTER** key to save the settings and return to the previous screen.

Otherwise, press the **SPACE** key (or the **Y** or **N** key) to toggle between the **Yes** and **No** and then press the **ENTER** key to save the settings and return to the previous screen.

### **Config:**

With the Add Operator screen displayed, the current setting for **Config:** will be shown. If the operator is allowed to change the configuration, press the **ENTER** key to save the settings and return to the previous screen.

Otherwise, press the **SPACE** key (or the **Y** or **N** key) to toggle between the **Yes** and **No** and then press the **ENTER** key to save the settings and return to the previous screen.

### **File Mgr:**

With the Add Operator screen displayed, the current setting for **File Mgr:** will be shown. If the operator is allowed to access the File Manager function, press the **ENTER** key to save the settings and return to the previous screen.

Otherwise, press the **SPACE** key (or the **Y** or **N** key) to toggle between the **Yes** and **No** and then press the **ENTER** key to save the settings and return to the previous screen.

## OPERATORS, CONT.

### 3. Edit Operator

The Edit Operator screen allows to you to change the operators previously configured access to functions and features of the indicator.

1. With the Setup Operators screen displayed, press the **3** key or use the Navigation Keys to select (highlight) **3. Edit Operator** and then press the **ENTER** key. The display will change to show the **Edit Operator** screen and prompt for the operator login (name).

```
Edit Operator
Login:      _
```

2. Enter the operator login and then press the **ENTER** key. The display will change to the Edit Operator screen and show the current settings.

```
Edit Operator
Login:      USER      Config:      No
Password:   File Mgr:  No
Zero:      Yes       Custom 1:   No
Keybd tare:Yes     Custom 2:   No
Push tare: Yes     Custom 3:   No
Print:     Yes       Custom 4:   No
Units:     Yes       Custom 5:   No
Sel Scale: No       Custom 6:   No
Date/time: Yes     Custom 7:   No
Enter login ID
```

# OPERATORS, CONT.

## Login:

With the Edit Operator screen displayed, the current login (name) will be shown. If the login displayed is acceptable, proceed to the next parameter.

Otherwise, use the alphanumeric keys to enter a new login for the operator (up to 8 characters) and then press the ▾ Down Arrow to advance to the next parameter.



**NOTE:** Changing the login REPLACES the current login. It DOES NOT create a new login in addition to existing login. It will however, retain the settings from the old login for the new login (e.g., **Zero: Yes, Keybd tare: No**, etc...).

## Password:

With the Edit Operator screen displayed, the current password will be shown. If the password displayed is acceptable, proceed to the next parameter.

Otherwise, use the alphanumeric keys to enter a new password for the operator (up to 8 characters) and then press the ▾ Down Arrow to advance to the next parameter. Note that if a password is not required (or desired), it can be left blank. **IMPORTANT!** The password will be visible while entering it. During operations, a row of asterisks will be shown when entering the password.



**NOTE:** To change the displayed setting on the following parameters, press the **SPACE** key to toggle between Yes and No or press the **Y** key for Yes or the **N** key for No.

## Zero:

With the Edit Operator screen displayed, the current setting for **zero:** will be shown. If the setting displayed is acceptable, proceed to the next parameter.

Otherwise, press the **SPACE** key (or the **Y** or **N** key) to toggle between the **Yes** and **No** and then press the ▾ Down Arrow to advance to the next parameter.

## Keybd tare:

With the Edit Operator screen displayed, the current setting for **Keybd tare:** will be shown. If the setting displayed is acceptable, proceed to the next parameter.

Otherwise, press the **SPACE** key (or the **Y** or **N** key) to toggle between the **Yes** and **No** and then press the ▾ Down Arrow to advance to the next parameter.

## Push tare:

With the Edit Operator screen displayed, the current setting for **Push tare:** will be shown. If the setting displayed is acceptable, proceed to the next parameter.

Otherwise, press the **SPACE** key (or the **Y** or **N** key) to toggle between the **Yes** and **No** and then press the ▾ Down Arrow to advance to the next parameter.

## OPERATORS, CONT.

### **Print:**

With the Edit Operator screen displayed, the current setting for **Print:** will be shown. If the setting displayed is acceptable, proceed to the next parameter.

Otherwise, press the **SPACE** key (or the **Y** or **N** key) to toggle between the **Yes** and **No** and then press the  $\nabla$  Down Arrow to advance to the next parameter.

### **Units:**

With the Edit Operator screen displayed, the current setting for **Units:** will be shown. If the setting displayed is acceptable, proceed to the next parameter.

Otherwise, press the **SPACE** key (or the **Y** or **N** key) to toggle between the **Yes** and **No** and then press the  $\nabla$  Down Arrow to advance to the next parameter.

### **Sel Scale:**

With the Edit Operator screen displayed, the current setting for **Sel Scale:** will be shown. If the setting displayed is acceptable, proceed to the next parameter.

Otherwise, press the **SPACE** key (or the **Y** or **N** key) to toggle between the **Yes** and **No** and then press the  $\nabla$  Down Arrow to advance to the next parameter.

### **Date/Time:**

With the Edit Operator screen displayed, the current setting for **Date/Time:** will be shown. If the setting displayed is acceptable, proceed to the next parameter.

Otherwise, press the **SPACE** key (or the **Y** or **N** key) to toggle between the **Yes** and **No** and then press the **ENTER** key to save the settings and return to the previous screen.

### **Config:**

With the Edit Operator screen displayed, the current setting for **Config:** will be shown. If the setting displayed is acceptable, proceed to the next parameter.

Otherwise, press the **SPACE** key (or the **Y** or **N** key) to toggle between the **Yes** and **No** and then press the **ENTER** key to save the settings and return to the previous screen.

### **File Mgr:**

With the Edit Operator screen displayed, the current setting for **File Mgr:** will be shown. If the setting displayed is acceptable, proceed to the next parameter.

Otherwise, press the **SPACE** key (or the **Y** or **N** key) to toggle between the **Yes** and **No** and then press the **ENTER** key to save the settings and return to the previous screen.

## OPERATORS, CONT.

### 4. Delete Operator

The Delete Operator screen allows you to delete (remove) an operator login and all previously configured settings for that login.

1. With the Setup Operators screen displayed, press the **4** key or use the Navigation Keys to select (highlight) **4. Delete Operator** and then press the **ENTER** key. The display will change to show the **Delete Operator** screen and prompt for the operator login (name).

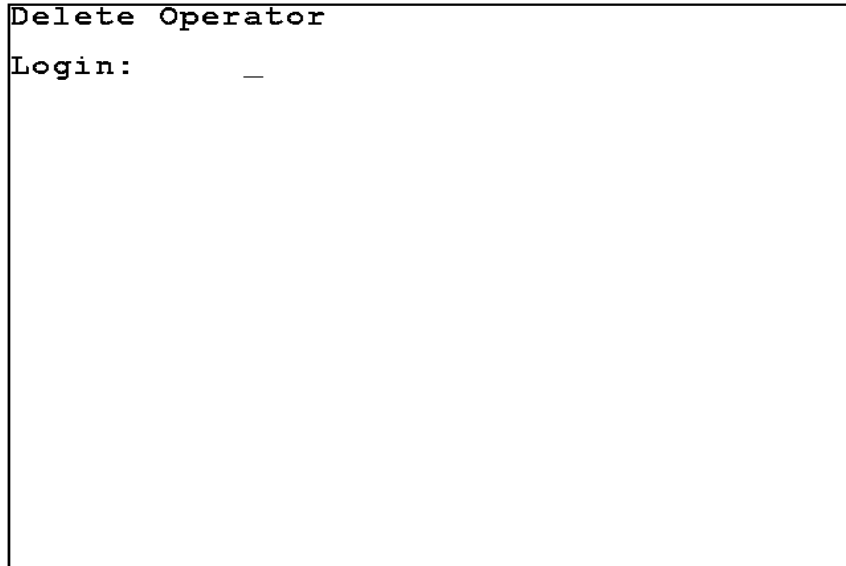

```
Delete Operator
Login:      _
```

2. Enter the operator login and then press the **ENTER** key.
3. The display will change to show  
**Are you sure?**
4. To delete the login, press the **Y** key (for Yes) and then press the **ENTER** key.
5. The display will change to show the Setup Operators screen. All settings for that operator login have been deleted.
6. Otherwise, press the **N** key (for No) and then press the **ENTER** key to return to the Setup Operators screen.

## OPERATORS, CONT.

### 5. Set Default Operator

The Set Default Operator screen allows to you to select which operator login the 825 will use when it is first turned on.

With the Setup Operators screen displayed, press the **5** key or use the Navigation Keys to select (highlight) **5. Set Default Operator** and then press the **ENTER** key. The display will change to show the **Set Default Operator** screen and the current default operator login (name).

```
Set Default Operator
Default Login: ADMIN
```

#### Default Login:

With the Set Default Operator screen displayed, the current login (name) will be shown. If the login displayed is acceptable, press the **ENTER** key to return to the Setup Operators screen.

Otherwise, use the alphanumeric keys to enter a new login for the default operator login and then press the **ENTER** key to return to the Setup Operators screen.

# CONFIGURATION

Configuration is used to: Calibrate the touch screen, Show the touch screen tracking (a target, the “+” sign will appear where the screen is touched), Set the color settings, Configure the weight server (the TCP/IP server, the serial ports and to view the Electronic Talley Roll), configure Ticket Settings and Configure the application menu.

## To Begin Configuration

1. Press the **ON/OFF** key to apply power to the 825. The display will perform a short self-test and then change to the Startup screen showing the software versions and diagnostics of the option cards.
2. When the 825 is initially started, a countdown starting at 7 seconds will appear to the right of 1. **Application Program**. Allow the countdown to complete or press the **ENTER** key or press the 1 key to select the **Application Program** option. The display will change to show:

Starting application mode

and then change to show:

Cardinal 825-loading...

Starting...

and then change to show the **Application Menu**.

<b>Application Menu</b>	<b>OS Version 1.12.009</b>
Truck / <u>I</u> D Storage By Cardinal	DFC <u>B</u> atcher By Cardinal
<u>C</u> heck Weigher By Cardinal	<u>H</u> ighway Weigh Station By Cardinal
<u>M</u> ulti Scale By Cardinal	Multi Scale ( <u>E</u> IP) By Cardinal
IP: 127.0.0.1	<u>N</u> ext >>

With the Application Menu displayed, press the **Next >>** key or use the Navigation Keys to select (highlight) **Next >>** and then press the **ENTER** key. The display will change to show the **Application Menu** screen for the additional applications.

# CONFIGURATION, CONT.

<b>Application Menu</b>	<b>OS Version 1.12.009</b>
<u>C</u> onfiguration By Cardinal	<u>F</u> ile Manager By Cardinal
<u>S</u> lide Show By Cardinal	
<< <u>P</u> rev	
IP: 127.0.0.1	



# CONFIGURATION, CONT.

## Configuration

3. With the Application Menu displayed, press the **U** key or use the Navigation Keys to select (highlight) **Configuration** and then press the **ENTER** key. The display will change to show the **Configuration** screen.

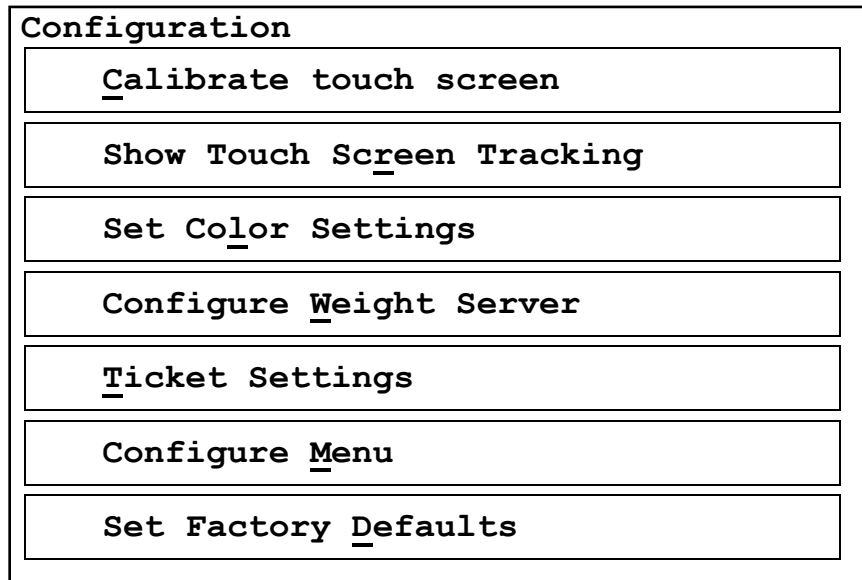

## Calibrate touch screen

With the Configuration screen displayed, press the **C** key or use the Navigation Keys to select (highlight) **Calibrate touch screen** and then press the **ENTER** key. The display will change to show the **Touch screen calibration** screen.

1. With the Touch screen calibration screen displayed, the target, a plus sign “+” will be shown in the upper left corner of the display.

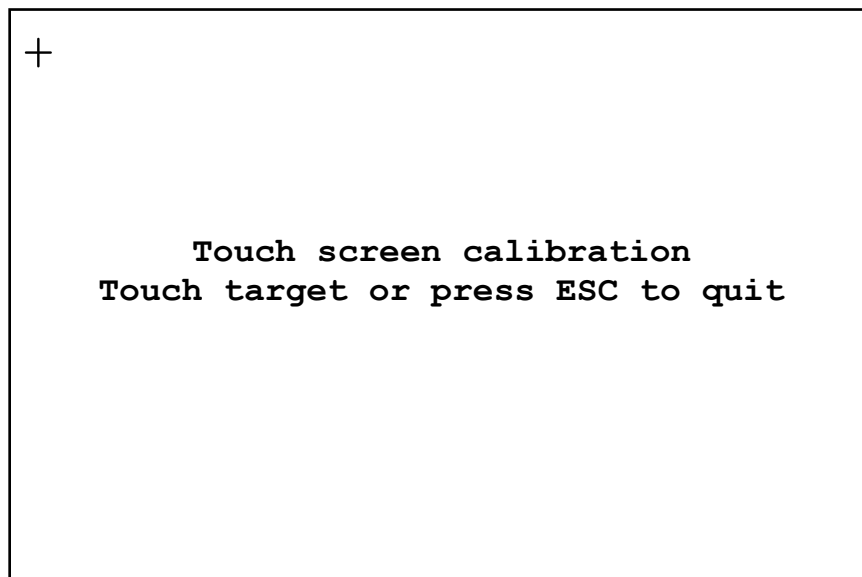

## CONFIGURATION, CONT.

2. Press the target firmly and accurately at each location on the screen. The target will continue to move until the screen is calibrated.



**NOTE:** Best accuracy will be obtained using a stylus (e.g. from a touch screen tablet, phone or computer).

### Show Touch Screen Tracking

With the Configuration screen displayed, press the **R** key or use the Navigation Keys to select (highlight) **Show Touch Screen Tracking** and then press the **ENTER** key. The display will change to show a tracking screen. Note that the screen will be blank except for a message (**Press [ESC] exit**) at the top center of the display.

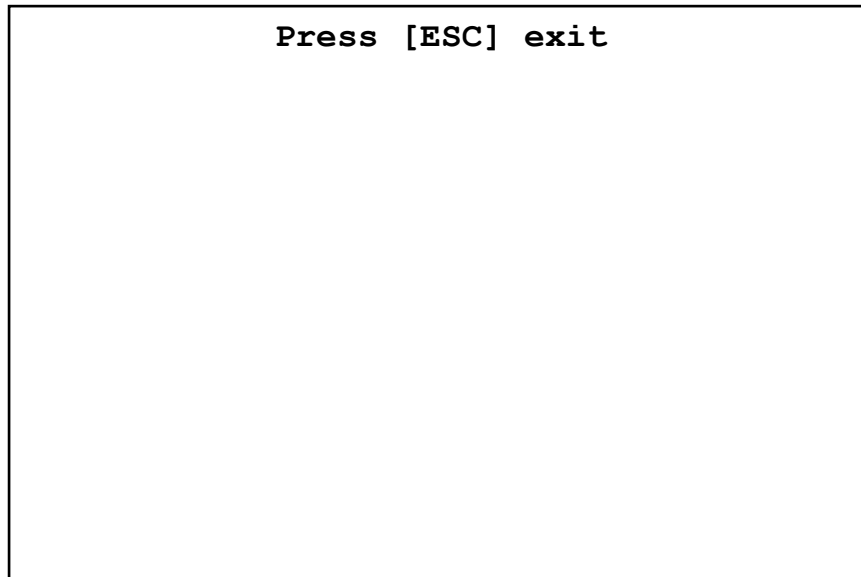

## CONFIGURATION, CONT.

1. With the blank tracking screen displayed, touch the screen in several locations.
2. The target, a plus sign “+” will move to each location touched.

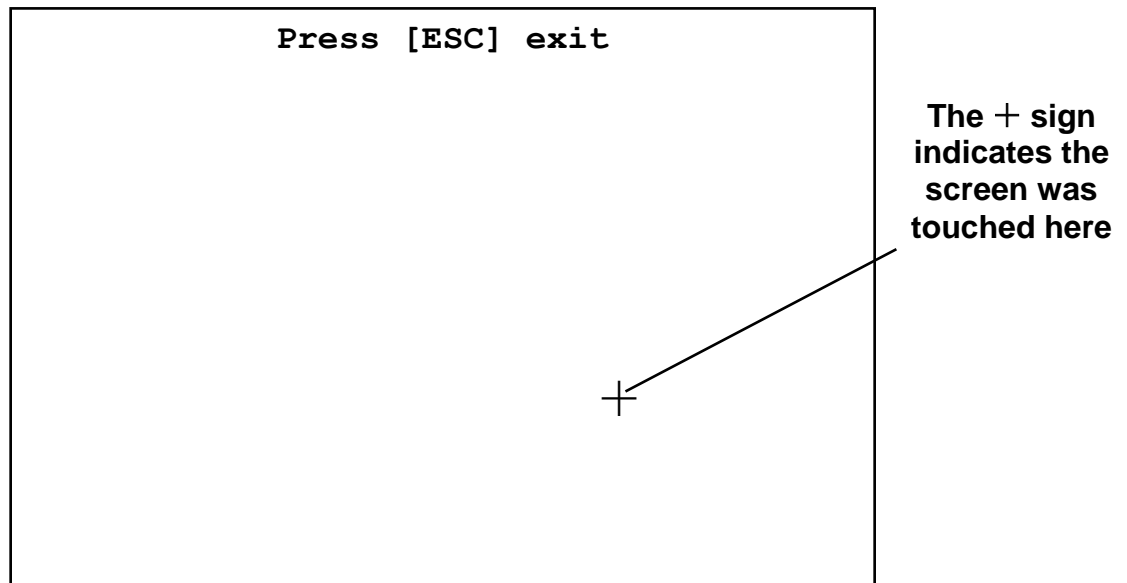

3. After checking several locations on the screen, press the **ESC** key to return to the Configuration screen.

## CONFIGURATION, CONT.

### Color Settings

With the Configuration screen displayed, press the **L** key or use the Navigation Keys to select (highlight) **Color Settings** and then press the **ENTER** key. The display will change to show the color selection screen.

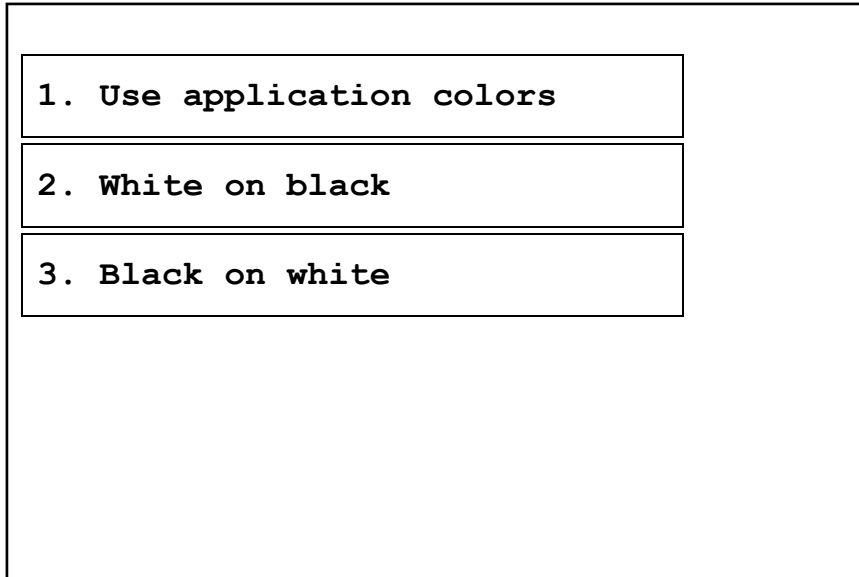

#### 1. Use application color

If the screen colors are to be controlled by the application program, press the **1** key or use the Navigation Keys to select (highlight) **1. Use application color** and then press the **ENTER** key. The screen will change to the new colors.

#### 2. White on black

If it is desired to have white characters on a black background for the screen colors, press the **2** key or use the Navigation Keys to select (highlight) **2. White on black** and then press the **ENTER** key. The screen will change to the white characters on a black background.

**White on black**

#### 3. Black on white

If it is desired to have black characters on a white background for the screen colors, press the **3** key or use the Navigation Keys to select (highlight) **3. Black on white** and then press the **ENTER** key. The screen will change to a white background with black characters on it.

**Black on white**

After setting the screen colors, press the **ESC** key to return to the Configuration screen.

## CONFIGURATION, CONT.

### Configure Weight Server

With the Configuration screen displayed, press the **W** key or use the Navigation Keys to select (highlight) **Configure Weight Server** and then press the **ENTER** key. The display will change to show the **Configure Weight Server** screen.

Configure Weight Server	
1.	Configure TCP/IP Server
2.	Configure Serial Ports
3.	Electronic Talley Roll

### 1. Configure TCP/IP Server

With the Configure Weight Server screen displayed, press the **1** key or use the Navigation Keys to select (highlight) **1. Configure TCP/IP Server** and then press the **ENTER** key. The display will change to show the **Select TCP/IP Server** screen.

Select TCP/IP Server		
Num	Sc Type	Port
1.	0 Custom	1100
2.	1 On Demand	1101
** Add Server **		

# CONFIGURATION, CONT.

## Select TCP/IP Server

With the Select TCP/IP Server screen displayed, press the **1** key or use the Navigation Keys to select (highlight) and then press the **ENTER** key to select Num 1. The display will change to show the **Setup TCP/IP Server 1** screen.

## Setup TCP/IP Server 1

### Enable:

With the Select TCP/IP Server 1 screen displayed, the current setting for the **Enable:** parameter will be shown. If the setting displayed is acceptable, proceed to the next parameter.

Otherwise, press the **SPACE** key to toggle its status. Select **YES\*** to enable TCP/IP Server 1 or **NO** to disable TCP/IP Server 1 and then press the **▽** Down Arrow to advance to the next parameter or press the **ENTER** key to save the new setting and return to the previous screen.

\* If Yes is selected for **Enable:**, the following additional parameters will be shown (below the Enable: parameter) and requires data to be entered. Otherwise, press the **ENTER** key to return to the **Select TCP/IP Server** screen.

### Port:

With the Select TCP/IP Server 1 screen displayed, the current setting for the **Port:** parameter will be shown. If the setting displayed is acceptable, proceed to the next parameter.

Otherwise, use the numeric keys to enter the TCP/IP port number and then press the **▽** Down Arrow to advance to the next parameter or press the **ENTER** key to save the new setting and return to the previous screen.

### Scale:

With the Select TCP/IP Server 1 screen displayed, the current setting for the **Scale:** parameter will be shown. If the setting displayed is acceptable, proceed to the next parameter.

Otherwise, use the numeric keys to enter the scale number for the server to use and then press the **▽** Down Arrow to advance to the next parameter or press the **ENTER** key to save the new setting and return to the previous screen.

## CONFIGURATION, CONT.

### Type :

With the Select TCP/IP Server 1 screen displayed, the current setting for the **Type :** parameter will be shown. If the setting displayed is acceptable, press the **ENTER** key to return to the **Select TCP/IP Server** screen.

Otherwise, press the **SPACE** key to step through and select the communication type and then press the **ENTER** key to save the new setting and return to the **Select TCP/IP Server** screen. Available types are:

<b>SB250</b>	<b>SB250M</b>	<b>SB500</b>	<b>SB500M</b>
<b>SB80</b>	<b>SB200</b>	<b>SB300</b>	<b>SB400</b>
<b>SMA</b>	<b>Computer Fmt</b>	<b>On Demand</b>	<b>iSite</b>
<b>Custom</b>			

### Setup TCP/IP Server 2

With the Select TCP/IP Server screen displayed, press the **2** key or use the Navigation Keys to select (highlight) and then press the **ENTER** key to select Num 2. The display will change to show the **Setup TCP/IP Server 2** screen.

The setup parameters for TCP/IP Server 2 are the same as TCP/IP Server 1. Refer to the Setup TCP/IP Server 1 parameters.

### \*\* Add Server \*\*

With the Select TCP/IP Server screen displayed, press the **A** key or use the Navigation Keys to select (highlight) and then press the **ENTER** key to select **\*\* Add Server \*\***. The display will change to show the **Setup TCP/IP Server 3** screen.

The setup parameters for adding an additional TCP/IP Server are the same as the setup for TCP/IP Server 1. Refer to the Setup TCP/IP Server 1 parameters.

## CONFIGURATION, CONT.

### 2. Configure Serial Ports

With the Configure Weight Server screen displayed, press the **2** key or use the Navigation Keys to select (highlight) **2. Configure Serial Ports** and then press the **ENTER** key. The display will change to show the **Select Serial** screen.

Select Serial			
Num	Sc	Type	Port
1.	0	On Demand	COM1
** Add Serial **			

### Select Serial

With the Select Serial screen displayed, press the **1** key or use the Navigation Keys to select (highlight) and then press the **ENTER** key to select Num 1. The display will change to show the **Setup Serial 1** screen.

### Setup Serial 1

#### Enable:

With the Select Serial 1 screen displayed, the current setting for the **Enable:** parameter will be shown. If the setting displayed is acceptable, proceed to the next parameter.

Otherwise, press the **SPACE** key to toggle its status. Select **YES\*** to enable the serial item or **NO** to disable the serial item and then press the **▽** Down Arrow to advance to the next parameter or press the **ENTER** key to save the new setting and return to the previous screen.

\* If Yes is selected for **Enable:**, the following additional parameters will be shown (below the Enable: parameter) and requires data to be entered. Otherwise, press the **ENTER** key to return to the **Select Serial** screen.



## CONFIGURATION, CONT.

### Port:

With the Select Serial 1 screen displayed, the current setting for the **Port:** parameter will be shown. If the setting displayed is acceptable, proceed to the next parameter.

Otherwise, press the **SPACE** key to step through and select the port to use for serial 1 and then press the  $\nabla$  Down Arrow to advance to the next parameter or press the **ENTER** key to save the new setting and return to the previous screen. Available ports are:

<b>COM1</b>	<b>COM2</b>	<b>COM3</b>	<b>COM4</b>
<b>USB-PRT1</b>	<b>USB-PRT2</b>	<b>USB-PRT3</b>	<b>USB-PRT4</b>
<b>USB-PRT5</b>	<b>USB-PRT6</b>	<b>USB-PRT6</b>	<b>USB-PC</b>
<b>NONE (blank)</b>			

### Scale:

With the Select Serial 1 screen displayed, the current setting for the **Scale:** parameter will be shown. If the setting displayed is acceptable, proceed to the next parameter.

Otherwise, use the numeric keys to enter the scale number for the serial port to use and then press the  $\nabla$  Down Arrow to advance to the next parameter or press the **ENTER** key to save the new setting and return to the previous screen.

### Type:

With the Select Serial 1 screen displayed, the current setting for the **Type:** parameter will be shown. If the setting displayed is acceptable, press the **ENTER** key to return to the **Select Serial** screen.

Otherwise, press the **SPACE** key to step through and select the communication type and then press the **ENTER** key to save the new setting and return to the **Select Serial** screen. Available types are:

<b>SB250</b>	<b>SB250M</b>	<b>SB500</b>	<b>SB500M</b>
<b>SB80</b>	<b>SB200</b>	<b>SB300</b>	<b>SB400</b>
<b>SMA</b>	<b>Computer Fmt</b>	<b>On Demand</b>	<b>Custom</b>

### \*\* Add Serial \*\*

With the Select Serial screen displayed, press the **A** key or use the Navigation Keys to select (highlight) and then press the **ENTER** key to select **\*\* Add Serial \*\***. The display will change to show the **Setup Serial 2** screen.

The setup parameters for adding an additional Serial port are the same as the setup for Serial 1. Refer to the Setup Serial 1 parameters.

## CONFIGURATION, CONT.

### Configuration of Weight Server Complete

To return to the Weight Screen and resume normal weighing operations, with the Select Serial screen (or the Select TCP/IP Server screen) displayed, press the Navigation Keys  $\triangleleft$  Left Arrow two (2) times. The display will change to show the Restart Weight Server screen.

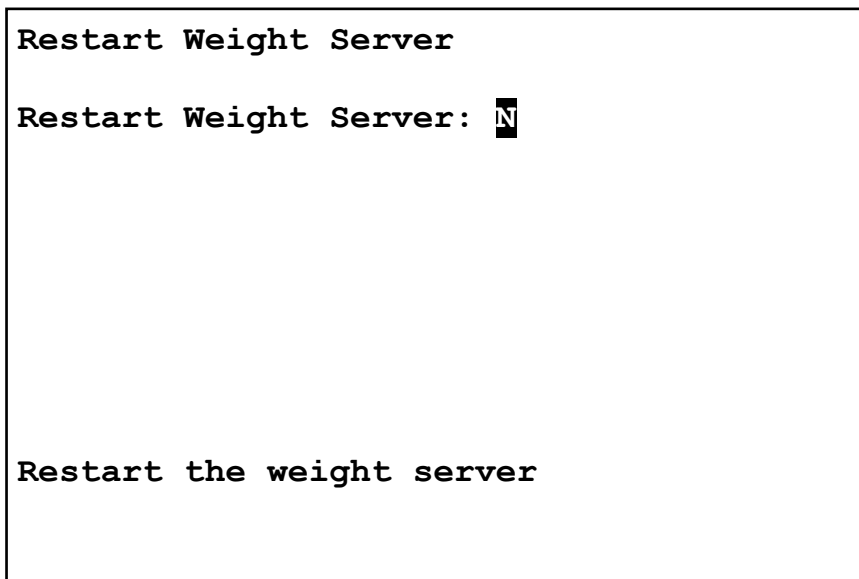

1. With the Restart Weight Server screen displayed, the current setting **Restart Weight Server: N** will be shown. If you are finished with the Configuration parameters, press the **SPACE** key to toggle its status from **No** to **Yes** and then press the **ENTER** key to restart the weight server.

Otherwise, press the **ENTER** key to return to the **Configuration** screen.

2. The display will change to show:

**Stopping weight server**

and then show:

**Starting weight server**

and then change to show the **Configuration** screen.

3. With the Configuration screen displayed, press the Navigation Keys  $\triangleleft$  Left Arrow to return to the **Application Menu**.
4. With the Application Menu displayed, press the key corresponding to the application to run and then press the **ENTER** key or use the Navigation Keys to select (highlight) the application to run and then press the **ENTER** key.
5. The application will be loaded and the display will change to the application screen.

# TICKET SETTINGS

With the Application Menu displayed, press the **U** key or use the Navigation Keys to select (highlight) **Configuration** and then press the **ENTER** key. The display will change to show the **Configuration** screen.

## Ticket Settings

With the Configuration screen displayed, press the **T** key or use the Navigation Keys to select (highlight) **Ticket Settings** and then press the **ENTER** key. The display will change to show the **Configure Ticket** screen.

Configure Ticket	
1. Standard	6. Special 2
2. Alternate	7. Special 3
3. First Pass	8. Special 4
4. Log	9. Special 5
5. Special 1	A. Special 6

**NOTE:** The setup parameters for the following tickets are the same.

- |               |              |              |              |
|---------------|--------------|--------------|--------------|
| 1. Standard   | 4. Log       | 7. Special 3 | A. Special 6 |
| 2. Alternate  | 5. Special 1 | 8. Special 4 |              |
| 3. First Pass | 6. Special 2 | 9. Special 5 |              |

After selecting the desired ticket to configure, refer to the following steps and parameters.

With the Configure Ticket screen displayed, press the key corresponding to the ticket to be configured and then press the **ENTER** key or use the Navigation Keys to select (highlight) the ticket to be configured and then press the **ENTER** key. The display will change to show the selected configure ticket screen.

### **Format:**

With the configure ticket screen displayed, the current setting for **Format:** will be shown. If the setting displayed is acceptable, press the  $\nabla$  Down Arrow to advance to the next parameter or press the **ENTER** key to return to the previous screen.

Otherwise, use the alphanumeric keys to enter the form name to use (up to 8 characters) and then press the  $\nabla$  Down Arrow to advance to the next parameter or press the **ENTER** key to save the new setting and return to the previous screen.

## TICKET SETTINGS, CONT.

### Port:

With the configure ticket screen displayed, the current setting for the **Port:** parameter will be shown. If the setting displayed is acceptable, press the **ENTER** key to return to the previous screen.

Otherwise, press the **SPACE** key to step through and select the port to use for the standard ticket and then press the **ENTER** key to save the new setting and return to the previous screen. Available ports are:

<b>COM1-RS232</b>	<b>COM1-Bluetooth</b>	<b>COM2</b>	<b>COM3</b>
<b>COM4</b>	<b>USB-PRT1</b>	<b>USB-PRT2</b>	<b>USB-PRT3</b>
<b>USB-PRT4</b>	<b>USB-PRT5</b>	<b>USB-PRT6</b>	<b>USB-PRT6</b>
<b>USB-PC</b>	<b>Custom*</b>		

\* If Custom is selected, an additional parameter (below the Port:) will be shown.

### Custom:

With the configure ticket screen displayed and Custom selected for the Port: parameter, the current setting for **Custom:** will be shown. If the setting displayed is acceptable, press the **ENTER** key to return to the previous screen.

Otherwise, use the alphanumeric keys to enter the port name to use and then press the **ENTER** key to save the new setting and return to the previous screen.

### Ticket:

With the Ticket Coordinates screen displayed, the current setting for the **Ticket:** parameter will be shown. If the setting displayed is acceptable, press the **ENTER** key to return to the previous screen.

Otherwise, press the **SPACE** key to step through and select the ticket to use and then press the **ENTER** key to save the new setting and return to the previous screen. Available tickets are:

<b>Default*</b>	<b>Standard</b>	<b>Alternate</b>	<b>First Pass</b>
<b>Log</b>	<b>Special 1</b>	<b>Special 2</b>	<b>Special 3</b>
<b>Special 4</b>	<b>Special 5</b>	<b>Special 6</b>	

\* If Default is selected, the display will change to the **Configure tabs page 1** screen. This is the screen to input the Print Tabs Settings.

# TICKET SETTINGS, CONT.

## PRINT TABS SETTING (General Format Information)

The general format for the input is:

**Label : Row, Col, Len, Label**

Where:

**Row** = the number of lines down.

**Col** = the number of spaces to the right.

**Len** = the number of data characters.

**Label** = the characters identifying the data printed.

**NOTE:** Enter 0 in **Row**, **Col** or **Len** to disable the data from printing.

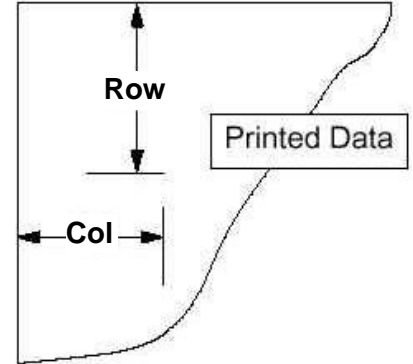

### Configure tabs page 1

With the Ticket Coordinates screen displayed, and Default selected for the Ticket: parameter, the display will change to the **Configure tabs page 1** screen.

Configure tabs page 1				
	Row	Col	Len	Label
Gross:	1	1	7	Gross:
Tare:	2	1	7	Tare:
Net:	3	1	7	Net:
Dsp Wt:	0	0	7	
Cnv. Gross:	0	0	0	
Cnv. Tare:	0	0	0	
Cnv. Net:	0	0	0	
Cnv. Dsp Wt:	0	0	0	
Display wt row coordinate				

If the setting displayed for each label is acceptable, press the **ENTER** key to advance to the **Configure tabs page 2** screen or press the **Left Arrow** to return to the previous screen.

Otherwise, use the numeric keys to enter the Row, Col and Len, pressing the **Right Arrow** to advance between each parameter and then press the **Right Arrow** to advance to the Label. Use the alphanumeric keypad for the Label characters.

Press the **Down Arrow** to advance to the next parameter.

**NOTE:** Use the **UP Arrow** key to “backup” to the previous coordinate or parameter.

## TICKET SETTINGS, CONT.

### Configure tabs page 2

With the Configure tabs page 1 screen displayed, press the **ENTER** key to advance to the Configure tabs page 2 screen.

Configure tabs page 2				
	Row	Col	Len	Label
G Accum:	0	0	10	
N Accum:	0	0	10	
Cnv G Accum:	0	0	0	
Cnv N Accum:	0	0	0	
Time:	5	1	8	Time: _
Date:	6	1	10	Date:
ID:	0	0	10	
Consec #:	0	0	10	
Time label				

If the setting displayed for each label is acceptable, press the **ENTER** key to advance to the Configure tabs page 3 screen or press the **Left Arrow** to return to the previous screen.

Otherwise, use the numeric keys to enter the Row, Col and Len, pressing the **Right Arrow** to advance between each parameter and then press the **Right Arrow** to advance to the Label. Use the alphanumeric keypad for the Label characters.

Press the **Down Arrow** to advance to the next parameter.

**NOTE:** Use the **UP Arrow** key to “backup” to the previous coordinate or parameter.

## TICKET SETTINGS, CONT.

### Configure tabs page 3

With the Configure tabs page 2 screen displayed, press the **ENTER** key to advance to the Configure tabs page 3 screen.

Configure tabs page 3				
	Row	Col	Len	Label
Piece Cnt:	0	0	10	
Tot Cnt:	0	0	10	
ID 1:	0	0	10	
ID 2:	0	0	10	
ID 3:	0	0	10	
Prompt 1:	0	0	10	
Prompt 2:	0	0	10	
Prompt 3:	0	0	10	
Piece count row coordinate				

If the setting displayed for each label is acceptable, press the **ENTER** key to advance to the Configure tabs page 4 screen or press the **Left Arrow** to return to the previous screen.

Otherwise, use the numeric keys to enter the Row, Col and Len, pressing the **Right Arrow** to advance between each parameter and then press the **Right Arrow** to advance to the Label. Use the alphanumeric keypad for the Label characters.

Press the **Down Arrow** to advance to the next parameter.

**NOTE:** Use the **UP Arrow** key to “backup” to the previous coordinate or parameter.

## TICKET SETTINGS, CONT.

### Configure tabs page 4

With the Configure tabs page 3 screen displayed, press the **ENTER** key to advance to the Configure tabs page 4 screen.

Configure tabs page 4				
	Row	Col	Len	Label
Ref 1:	0	0	10	
Ref 2:	0	0	10	
Ref 3:	0	0	10	
In Time:	0	0	10	
In Date:	0	0	10	
ID 4:	0	0	10	
Prompt 4:	0	0	10	
Custom:	0	0	10	
Reference 1				
Row coordinate (1-132, 0=Do not print)				

If the setting displayed for each label is acceptable, press the **ENTER** key to advance to the Configure tabs page 5 screen or press the **◀** Left Arrow to return to the previous screen.

Otherwise, use the numeric keys to enter the Row, Col and Len, pressing the **▶** Right Arrow to advance between each parameter and then press the **▶** Right Arrow to advance to the Label. Use the alphanumeric keypad for the Label characters.

Press the **▼** Down Arrow to advance to the next parameter.

**NOTE:** Use the **▲** UP Arrow key to “backup” to the previous coordinate or parameter.



## TICKET SETTINGS, CONT.

### Configure tabs page 5

With the Configure tabs page 4 screen displayed, press the **ENTER** key to advance to the Configure tabs page 5 screen.

```
Configure tabs page 5
Header 1 - Row: 0   Col:0
:
Header 2 - Row: 0   Col:0
:
Header 3 - Row: 0   Col:0
:
Header 4 - Row: 0   Col:0
:
Header 5 - Row: 0   Col:0
:
Header 1 row coord
```

If the setting displayed for each label is acceptable, press the **ENTER** key to advance to the Configure tabs page 6 screen or press the **◀** Left Arrow to return to the previous screen.

Otherwise, use the alphanumeric keys to enter the description (up to 35 characters) for the first line of the header and then press the **▽** Down Arrow to advance to the next line. Note that pressing the **△** UP Arrow key will “backup” to the previous line.

Continue using the alphanumeric keys to enter the description for each line of the Header, pressing the **▽** Down Arrow key to advance to the next line.

Press the **▽** Down Arrow to advance to the next parameter.

**NOTE:** Use the **△** UP Arrow key to “backup” to the previous coordinate or parameter.

## TICKET SETTINGS, CONT.

### Configure tabs page 6

With the Configure tabs page 5 screen displayed, press the **ENTER** key to advance to the **Configure tabs page 6** screen.

```
Configure tabs page 6
Footer 1 - Row: 0 Col:0
:
Footer 2 - Row: 0 Col:0
:
Footer 3 - Row: 0 Col:0
:
Footer 4 - Row: 0 Col:0
:
Footer 5 - Row: 0 Col:0
:
Footer 1 row coord
```

If the setting displayed for each label is acceptable, press the **ENTER** key to advance to the **Configure tabs page 6** screen or press the **◀** Left Arrow to return to the previous screen.

Otherwise, use the alphanumeric keys to enter the description (up to 35 characters) for the first line of the footer and then press the **▽** Down Arrow to advance to the next line. Note that pressing the **△** UP Arrow key will “backup” to the previous line.

Continue using the alphanumeric keys to enter the description for each line of the Footer, pressing the **▽** Down Arrow key to advance to the next line.

Press the **▽** Down Arrow to advance to the next parameter.

**NOTE:** Use the **△** UP Arrow key to “backup” to the previous coordinate or parameter.

When the description for all lines of the Header and Footer have been entered, press the **ENTER** key to save the new settings and return to the **Configure Ticket** screen.

## TICKET SETTINGS, CONT.

### Configure tabs page 7

With the Configure tabs page 5 screen displayed, press the **ENTER** key to advance to the Configure tabs page 7 screen.

```
Configure tabs page 7
Begin Print Codes
1:  _
2:
3:
4:
5:
End Print Codes
1:
2:
3:
4:
5:

Begin Print Codes 1
```

If the setting displayed for each line of the Begin Print Codes or the End Print Codes is acceptable, press the **ENTER** key to return to the **Configure Ticket** screen.

Otherwise, use the alphanumeric keys to enter Begin Print Codes (up to 35 characters) for the first line and then press the ▾ Down Arrow to advance to the next line. Note that pressing the △ UP Arrow key will “backup” to the previous line.

Continue using the alphanumeric keys to enter the codes for each line of the Begin Print Codes and End Print Codes, pressing the ▾ Down Arrow key to advance to the next line.

825 Enter As	Hex	Dec	Description
<CR>	0D	13	Carriage return
<LF>	0A	10	Line feed
<ESC>	1B	27	Escape
<STX>	02	2	Start of text
<ETX>	03	3	End of text
<0xHH>	HH		Send any character code for example <0x1B> would output the escape character (the same as <ESC>), <0xFE> would output the character FE hex (254 decimal).

When all Begin and End Print Codes have been entered, press the **ENTER** key to save the new settings and return to the **Configure Ticket** screen.

# CONFIGURE APPLICATION MENU

With the Application Menu displayed, press the **U** key or use the Navigation Keys to select (highlight) **Configuration** and then press the **ENTER** key. The display will change to show the **Configuration** screen.

## Configure Menu

With the Configuration screen displayed, press the **M** key or use the Navigation Keys to select (highlight) **Configure Menu** and then press the **ENTER** key. The display will change to show the **Configure Application Menu** screen.

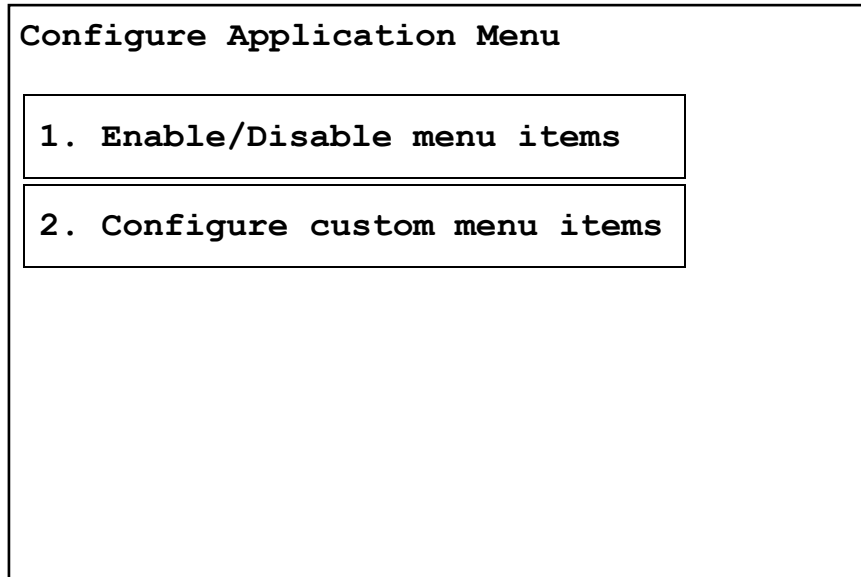

## 1. Enable/Disable menu items

With the Configure Application Menu displayed, press the **1** key or use the Navigation Keys to select (highlight) **1. Enable/Disable menu items** and then press the **ENTER** key. The display will change to show the **Configure Menu** screen.

## Application:

With the Configure Menu screen displayed, the current setting for the **Application:** parameter will be shown. If the setting displayed is acceptable, press the  $\nabla$  Down Arrow to proceed to the next parameter.

Otherwise, press the **SPACE** key to step through and select the applications to be shown on the Application Menu screen and then press the  $\nabla$  Down Arrow to advance to the next parameter or press the **ENTER** key to save the new setting and return to the previous screen. Available applications are:

<b>All</b>	<b>None</b>	<b>Truck / ID Storage</b>
<b>DFC Batcher</b>	<b>Checkweigher</b>	<b>Highway Weigh Station</b>
<b>Multi Scale</b>	<b>Multi Scale (EIP)</b>	

# CONFIGURE APPLICATION MENU, CONT.

## Custom Activity:

With the Configure Menu screen displayed, the current setting for the **Custom Activity:** parameter will be shown. If the setting displayed is acceptable, press the ▽ Down Arrow to proceed to the next parameter.

Otherwise, press the **SPACE** key to toggle its status (select ALL or NONE) and then press the ▽ Down Arrow to advance to the next parameter or press the **ENTER** key to save the new setting and return to the previous screen.

### Custom Activity: All

Custom Activity is enabled for ALL applications.

### Custom Activity: None

With None selected, Custom Activity is disable.

## File Manager:

With the Configure Menu screen displayed, the current setting for the **File Manager:** parameter will be shown. If the setting displayed is acceptable, press the ▽ Down Arrow to proceed to the next parameter.

Otherwise, press the **SPACE** key to toggle its status (select YES or NO) and then press the ▽ Down Arrow to advance to the next parameter or press the **ENTER** key to save the new setting and return to the previous screen.

### File Manager: Yes

Select Yes to include the File Manager selection on the Application Menu.

### File Manager: No

The File Manager selection is not displayed on the Application Menu.

## Slide Show:

With the Configure Menu screen displayed, the current setting for the **Slide Show:** parameter will be shown. If the setting displayed is acceptable, press the ▽ Down Arrow to proceed to the next parameter.

Otherwise, press the **SPACE** key to toggle its status (select YES or NO) and then press the ▽ Down Arrow to advance to the next parameter or press the **ENTER** key to save the new setting and return to the previous screen.

### Slide Show: Yes

Select Yes to include the Slide Show selection on the Application Menu.

### Slide Show: No

The Slide Show selection is not displayed on the Application Menu.

## CONFIGURE APPLICATION MENU, CONT.

### Auto run: \*

With the Configure Menu screen displayed, the current setting for the **Auto run:** parameter will be shown. If the setting displayed is acceptable, press the **ENTER** key or the Navigation Keys < Left Arrow to return to the previous screen.

Otherwise, press the **SPACE** key to step through and select the application to auto run (automatically load and run from the Application Menu screen) and then press the ▾ Down Arrow to advance to the next parameter or press the **ENTER** key to save the new setting and return to the previous screen. Available applications are:

<b>None</b>	<b>Truck / ID Storage</b>	<b>DFC Batcher</b>
<b>Checkweigher</b>	<b>Configuration</b>	<b>File Manager</b>
<b>Transfer</b>	<b>Slide Show</b>	<b>Return to Startup</b>

\* If an application is selected to “auto run”, an additional parameter (below the Auto run:) will be shown.

### Auto run secs:

With the Configure Menu screen displayed and an application selected to “auto run”, the current setting for **Auto run secs:** will be shown. If the setting displayed is acceptable, press the **ENTER** key to return to the previous screen.

Otherwise, use the numeric keys to enter the number of seconds before the application automatically loads and runs (countdown timer on the Application Menu screen) and then press the **ENTER** key to save the new setting and return to the previous screen. Supported countdown times are 2 through 90 seconds.

## SET FACTORY DEFAULTS

With the Application Menu displayed, press the **U** key or use the Navigation Keys to select (highlight) **Configuration** and then press the **ENTER** key. The display will change to show the **Configuration** screen.

### Set Factory Defaults

With the Configuration screen displayed, press the **D** key or use the Navigation Keys to select (highlight) **Set Factory Defaults** and then press the **ENTER** key. The display will change to show the **Configure Application Menu** screen.

```
Set Defaults
Warning - This will erase all
application data such as truck IDs and
custom applications.
Calibration will not be affected.
ERASE (Y/N)?
```

### ERASE (Y/N)?

With the Set Defaults Warning message displayed, press the **Y** key to proceed with setting the indicator back to the factory defaults.

Otherwise, press the **N** key to return to the **Configuration** screen.



**IMPORTANT:** To set the indicator back to the factory defaults, you must type

**E R A S E**

one letter per screen and then press the **ENTER** key on the last screen.

**NOTE:** You can cancel the operation at any time by pressing **any other key**.

## SET FACTORY DEFAULTS, CONT.

### Confirm Set Defaults

After pressing the **Y** key to proceed with setting the indicator back to the factory defaults, the display will change to show the first of six (6) Confirm Set Defaults screens.

```
Confirm Set Defaults
Press E (or any other key to cancel)
```

Press the **E** key to proceed to the next Confirm Set Defaults screen.

Otherwise, press **any other key** to cancel and return to the **Configuration** screen.

```
Press R (or any other key to cancel)
```

Press the **R** key to proceed to the next Confirm Set Defaults screen.

Otherwise, press **any other key** to cancel and return to the **Configuration** screen.

```
Press A (or any other key to cancel)
```

Press the **A** key to proceed to the next Confirm Set Defaults screen.

Otherwise, press **any other key** to cancel and return to the **Configuration** screen.

```
Press S (or any other key to cancel)
```

Press the **S** key to proceed to the next Confirm Set Defaults screen.

Otherwise, press **any other key** to cancel and return to the **Configuration** screen.

```
Press E (or any other key to cancel)
```

Press the **E** key to proceed to the next Confirm Set Defaults screen.

Otherwise, press **any other key** to cancel and return to the **Configuration** screen.



## SET FACTORY DEFAULTS, CONT.

Confirm Set Defaults

Press ENTER (Erase will begin)

Press the **ENTER** key to begin erasing ALL application data and custom applications in the indicator.

Otherwise, press **any other key** to cancel and return to the **Configuration** screen.



**IMPORTANT:** Even though the “press any other key to cancel” message is not displayed, you **CAN** press **any other key** to cancel erasing the indicator memory and setting the indicator back to the factory defaults. The display will show **Cancelled** and return to the **Configuration** screen.

# APPLICATION MENU SCREEN

The Application Menu screen may consist of more than one screen. Press the **NEXT >>** key to view additional selections. Press the **<< Prev** key to return to the first screen.

Application Menu	OS Version 1.12.009
Tr <u>u</u> ck / <u>I</u> D Storage By Cardinal	DFC <u>B</u> atcher By Cardinal
<u>C</u> heck Weigher By Cardinal	<u>H</u> ighway Weigh Station By Cardinal
<u>M</u> ulti Scale By Cardinal	Multi Scale ( <u>E</u> IP) By Cardinal
IP: 127.0.0.1	
<b><u>N</u>ext &gt;&gt;</b>	

With the Application Menu displayed, press the **Next >>** key or use the Navigation Keys to select (highlight) **Next >>** and then press the **ENTER** key. The display will change to show the **Application Menu** screen for the additional applications.

Application Menu	OS Version 1.12.009
Config <u>u</u> ration By Cardinal	<u>F</u> ile Manager By Cardinal
<u>S</u> lide Show By Cardinal	
<b>&lt;&lt; <u>P</u>rev</b>	
IP: 127.0.0.1	

# TROUBLESHOOTING

The 825 is equipped with diagnostic software that tests various portions of the indicator's circuitry and verifies proper operation. Should a problem be detected, an error or status message will be displayed alerting the operator to that condition. The following lists these status messages and errors and their meaning.

## Weight Status Messages (Displayed concurrently with weight)

### MOTION

The scale is in motion based on motion range parameter.

### BELOW ZERO

The gross scale weight reading is below zero.

### CENTER ZERO

The gross scale weight reading is at center of zero.

## Weight Status Messages (Displayed in place of weight)

### OVER CAPACITY

The scale weight is over capacity (104% of calibrated capacity).

### WEIGHT ERROR

Weight input signal is out of acceptable range. This may indicate a disconnected or failing load cell.



**IMPORTANT!** The Totalizer display shows the individual weighing element status in abbreviated form – **MO** = MOTION, **BZ** = BELOW ZERO, **CZ** = CENTER ZERO, **OVERCAP** = OVER CAPACITY. The Total weight display status is displayed as above.

## Operation Messages (Momentarily displayed after operator attempts an action)

### CANNOT ZERO – MOTION

Attempt to zero scale while in motion.

### CANNOT ZERO – OUT OF RANGE

Attempt to zero beyond allowed range.

### Cannot set tare

Tare value invalid.

### Cannot change weight units

Scale configured for single weight units: custom, lb, or kg.

## **TROUBLESHOOTING, CONT.**

### **Operation Messages, Cont.**

#### **Cannot show net - no tare**

The "NET" key operation to show gross, tare, and net weights is not permitted when there is no tare weight.

#### **Cannot print MOTION**

Attempt to print ticket while scale is in motion.

#### **Cannot print OVER CAPACITY**

Attempt to print ticket while scale is over capacity.

#### **Cannot print BELOW ZERO**

Attempt to print ticket while scale is below zero.

#### **Cannot print WEIGHT ERROR**

Attempt to print ticket during WEIGHT ERROR condition.

#### **Operator not allowed to change scale**

The current operator login does not permit changing the current scale selection.

#### **Operator not allowed tare**

The current operator login does not permit using the keypad tare selection.

#### **Operator not allowed push button tare**

The current operator login does not permit using the push-button tare selection.

#### **Operator not allowed to set date/time**

The current operator login does not permit setting the date/time.

#### **Operator not allowed to chg units**

The current operator login does not permit changing the current unit selection.

#### **Operator not allowed to print**

The current operator login does not permit using the print function.

# TROUBLESHOOTING, CONT.

## **Error Codes (Diagnostic Messages)**

### **ERROR – LOST COMMUNICATION WITH MAINBOARD**

The operator interface board did not receive response from main board before timeout. This could indicate a problem with the main board processor, power connections, or connections between main board and operator interface board.

## **Error Codes (During Startup)**

### **Mainboard Test Program**

The main board is loaded with diagnostic test software. Weight indicator functions are not possible.

### **Cannot receive status from mainboard**

The operator interface board requested status from the main board and there was no response before a timeout occurred. This could indicate a problem with the main board processor, power connections, or connections between main board and operator interface board.

### **Mainboard status: good**

Initial startup response from main board indicates no problems.

### **Mainboard status: A000**

Initial startup response from main board indicates main board bootloader software is present, but main board program is not present or damaged. Weight indicator functions are not possible.

### **SIB status: good**

Initial startup response from main board indicates no problems with scale interface card.

### **Press ENTER or self-test in X secs (X = countdown)**

Operator interface board flash memory indicates the unit has not completed initial board tests successfully. Press enter before countdown completes to bypass testing. However, this message will continue to appear upon power-up until testing is completed successfully.

## **Error Codes (During View Audit Trail)**

### **Mnbd reports 01 EEPROM corrupt**

The checksum failed. There may be a problem with the EEPROM chip on the mainboard.

# TROUBLESHOOTING, CONT.

## Error Codes (During Add Operator)

### Cannot use same login as existing operator

An attempt was made to enter a new operator using the same login as an existing operator.

### No space for new operator

An attempt was made to add a new operator when all operator login spaces are filled. The Model 825 supports a total of eight operators. One operator is the Administrator (with full access to all functions and features). The remaining seven are for users and can be configured to allow or prevent access to various functions and features.

## Error Codes (During Edit Operator / Delete Operator / Set Default Operator)

### Operator not found

The operator login entered does not exist.

### Cannot delete ADMIN operator

An attempt was made to delete the administrator login. The administrator login cannot be deleted.

## Before You Call Service

The Model 825 indicator has been designed to provide you with years of trouble-free operation. In spite of this, troubles sometimes happen. Before calling for service assistance, you should make some initial checks to verify that a problem does exist. The following describes several types of symptoms along with suggested remedies.

<b><u>PROBLEM</u></b>	<b><u>POSSIBLE SOLUTIONS</u></b>
Display does not turn on	Is the AC power cord fully inserted into the wall receptacle? Check wall receptacle for proper AC power. Try another electrical appliance in the same receptacle. Does it work? Check the circuit breaker. Has there been power failure?
Incorrect weight displayed	Has the indicator been calibrated? Insure that the scale platform is not touching an adjacent object. Check the load cell connector wiring. If using four (4) wire load cells, insure the sense lead jumpers (J1 and J3) on the 825-SIB are installed. Have proper operation procedures been followed?
Indicator will not display weight	Refer to Weight Status Messages section and make certain that the <b>OVER CAPACITY</b> message is not displayed. If so, and scale is not loaded, perform the calibration procedure.

# DIAGNOSTICS

## Startup Screen

1. Press the **ON/OFF** key to turn on the 825.
2. The display will perform a short self-test and then change to the Startup screen. Note that when the 825 is initially started, a countdown starting at 7 seconds will appear to the right of 1. **Application program**. When the countdown is complete, the application program will automatically start.
3. To allow unlimited time to review the Startup screen, press the Navigation Keys ▽ Down Arrow or △ UP Arrow to stop the countdown.
4. The following describes the Startup screen.

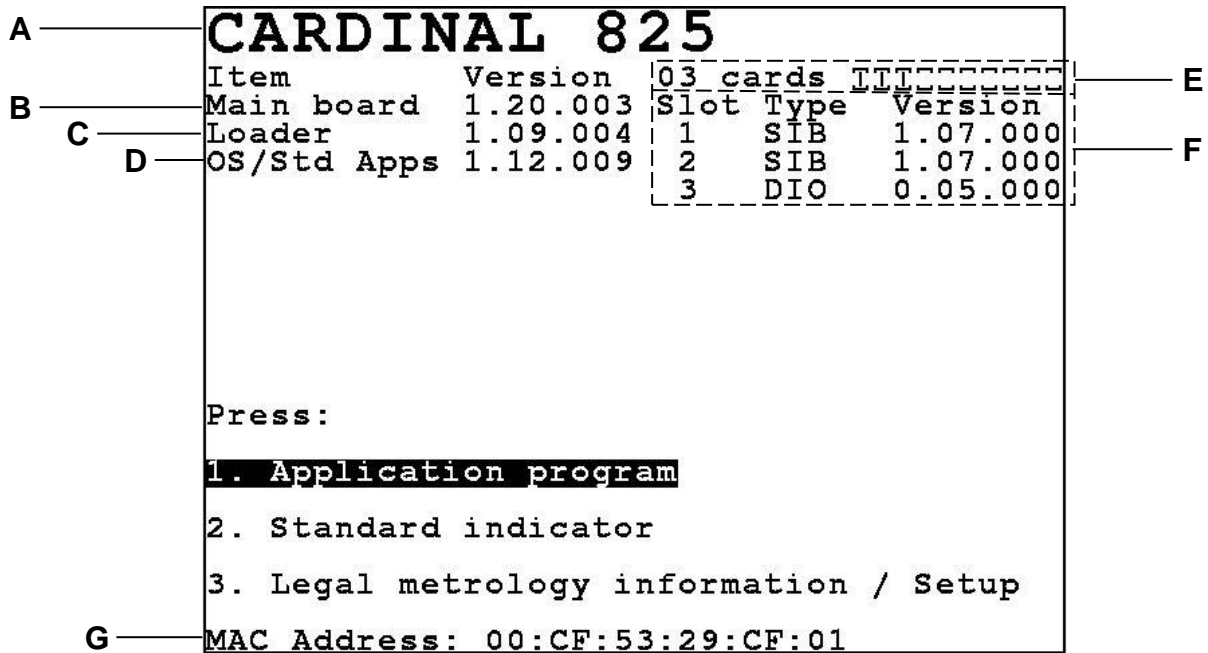

- A. The top left of the Startup screen displays the indicator model number, Cardinal 825.
- B. This is the main board software version.
- C. This item identifies the version of the boot loader software (e.g., Loader: 1.09.004).
- D. This is the operating system (OS) version (e.g., 1.12.009).
- E. This line identifies how many option cards are installed into the main board and what slots they are installed in. A graphic representation of the 10 slots is shown with the filled ones indicator. From the left to right, the slots are numbered one through ten.
- F. This part of the screen lists the installed option cards. Each option card is shown on one line in the slot it occupies, the type of card and the card software version
- G. This is the MAC Address of the indicator.

# DIAGNOSTICS, CONT.

## To Begin Diagnostics

With the Startup screen showing, press the Navigation Keys ▾ Down Arrow to “advance” to (highlight) the **Setup menu** option and then press the **ENTER** key or press the **3** key to select the **Setup menu** option. The display will change to show the **Setup Menu** screen.



**NOTE:** If the Login and Password protection feature has been enable, the **Login** screen will be displayed instead of the **Setup Menu** screen. Enter the login and then press the ▾ Down Arrow to advance to the password prompt. Enter the password and then press the **ENTER** key to proceed to the Setup Menu.

```
Setup Menu
Press:
1. Date/Time
2. Communication
3. Calibration
4. Update software menu
5. Preferences
6. Diagnostics
7. Operators

MAC Address: 00:CF:53:29:CF:01
```

## Diagnostic Menu

With the Setup Menu displayed, press the **6** key or use the Navigation Keys to select (highlight) **6. Diagnostics** and then press the **ENTER** key. The display will change to show the **Diagnostics Menu** screen.

```
Diagnostics Menu
Press:
1. Mainboard comm. test
2. Mainboard I/O test
3. SDRAM test
4. NOR Flash test
```



## DIAGNOSTICS, CONT.

### Mainboard comm test

With the Diagnostics Menu displayed, press the **1** key or use the Navigation Keys to select (highlight) **1. Mainboard comm. test** and then press the **ENTER** key. The display will change to show the **Mainboard comm. test** screen.

```
Mainboard comm. test
Testing   Action   Address   Errors
```

### Test Mainboard I/O

With the Diagnostics Menu displayed, press the **2** key or use the Navigation Keys to select (highlight) **2. Mainboard I/O test** and then press the **ENTER** key. The display will change to show the **Test Mainboard I/O** screen.

```
Test Mainboard I/O

This test cycles digital outputs and
reads inputs. Loop-back connections
are required to prevent errors.

I/O Code From:      0
I/O Code To:        15
Card (0 mnbd):      0

Enter the starting code
out1=1, out2=2, out3=4, out4=8
example 5=out1 and 3
```

## DIAGNOSTICS, CONT.

### SDRAM Test

With the Diagnostics Menu displayed, press the **3** key or use the Navigation Keys to select (highlight) **3**. **SDRAM test** and then press the **ENTER** key. The display will change to show the **Test SDRAM** screen.

```
Test SDRAM

Address from:      40020000
Address to:        41F7FFFF
Address increment: 00000001
Starting value:    0
Value increment:   1

Enter the starting address
in hexadecimal.
```

### NOR Flash Test

With the Diagnostics Menu displayed, press the **4** key or use the Navigation Keys to select (highlight) **4**. **NOR Flash test** and then press the **ENTER** key. The display will change to show the **Test NOR Flash** screen.

```
Test NOR Flash
This test ERASES the boot-loader
and operating sytem. This test must
be performed only at properly equipped
programming stations.

NOR test password: _

Enter the password
```

### **\* \* \* WARNING! \* \* \***



Performing the **Test NOR Flash** test will **ERASE** the boot-loader and operating system. This test must be performed only at properly equipped programming stations.



## FINE SPAN ADJUSTMENT

If after performing linearization testing, an error in the overall weight (span setting of the scale) or an error in a specific range of weight is found, adjustments can be made using the procedures described below.

1. Press the **ON/OFF** key to turn on the 825. The display will perform a short self-test and then change to the Startup screen showing the software versions and diagnostics of the option cards.
2. Press the Navigation Keys  $\nabla$  Down Arrow to “advance” to (highlight) the **Legal metrology information / Setup** option and then press the **ENTER** key or press the **3** key to select the **Legal metrology information / Setup** option. The display will change to show the **Legal metrology information / Setup** screen.



**NOTE:** If the Login and Password protection feature has been enable, the **Login** screen will be displayed instead of the **Legal metrology information / Setup** screen. Enter the login and then press the  $\nabla$  Down Arrow to advance to the password prompt. Enter the password and then press the **ENTER** key to proceed to the Setup Menu.

3. With the Setup Menu displayed, press the **3** key or use the Navigation Keys to select (highlight) **3. Calibration** and then press the **ENTER** key. The display will change to show the **Setup Scale Number** screen.
4. With the Setup Scale Number screen displayed, verify the correct scale number is shown and then press the **ENTER** key. Otherwise, use the numeric keys to enter the scale number and then press the **ENTER** key.
5. The display will change to show the **Scale 1 – Calibration Options** screen.
6. From the Scale 1 – Calibration Options screen, press the **3** key or use the Navigation Keys to select (highlight) **3. Fine Span** and then press the **ENTER** key.
7. With the **Scale 1 – Fine Span** screen displayed, place a calibrated test weight on the scale.

Use the Navigation Keys to select (highlight) the Fine Span adjustment option and then press the **ENTER** key to perform the function or;

Press the **U** key (U. Up) to increase displayed weight.

Press the **D** key (D. Down) to decrease the displayed weight,

Press the **Z** key (Z. Zero) to zero the scale.

Press the **Q** key (Q. Quit) to save the current settings and Quit.

The display will return to the **Scale 1 – Calibration Options** screen.

## FINE SPAN ADJUSTMENT, CONT.

If **2nd Order Linearization** was enabled and the **Num Cal Pts** parameter is set for 2 or more, then a **COEFF** option will be added to the Fine Span screen. This option is used to adjust the displayed weight after testing has shown an error in a specific range of weight.

Press the **C** key or use the Navigation Keys to select (highlight) the **Coef** option and then press the **ENTER** key to proceed to the **Coefficient** screen.

### **Linear Coefficient:**

The Linear Coefficient is applied to the load cell signal to calculate weight. If the current setting displayed for this coefficient is acceptable, press the  $\nabla$  Down Arrow to advance to the **2nd Order Coeff:** parameter.

Otherwise, use the numeric keys to enter a new Linear Coefficient and then press the  $\nabla$  Down Arrow to advance to the next parameter.

### **2nd Order Coeff:**

This coefficient is applied to the square of the load cell signal to calculate weight. If the current 2nd Order Coeff setting displayed is acceptable, press the  $\nabla$  Down Arrow to advance to the **Tweak low weight:** parameter.

Otherwise, use the numeric keys to enter a new 2nd Order Coeff and then press the  $\nabla$  Down Arrow to advance to the next parameter.



**WARNING! Changing the Linear Coefficient or the 2nd Order Coeff will affect the indicator's ability to display the proper weight. Please consult the factory before making any changes.**

### **Tweak low weight:**

This is the low end of the range of weight that requires adjusting. For example, if after performing linearization testing, the displayed weight is 5 lbs low between 10,000 lbs and 15,000 lbs, the value for the tweak low weight is 10000.

If the setting displayed is acceptable, press the  $\nabla$  Down Arrow to advance to the **Tweak high weight:** parameter.

Otherwise, use the numeric keys to enter the tweak low weight and then press the  $\nabla$  Down Arrow to advance to the next parameter.

### **Tweak high weight:**

This is the high end of the range of weight that requires adjusting. Using the example above, the value for the tweak high weight is 15000.

If the setting displayed is acceptable, press the  $\nabla$  Down Arrow to advance to the **Tweak weight:** parameter.

Otherwise, use the numeric keys to enter the tweak high weight and then press the  $\nabla$  Down Arrow to advance to the next parameter.

## FINE SPAN ADJUSTMENT, CONT.

### **Tweak weight:**

This is the amount of weight that needs to be added (or subtracted) from the range of weight to bring the displayed weight into tolerance. Again, using the example above, the Tweak Weight would be 5.

If the setting displayed is acceptable, press the **ENTER** key to return to the **Scale 1 - Fine Span** screen.

Otherwise, use the numeric keys to enter a new tweak weight and then press the **ENTER** key to return to the **Scale 1 - Fine Span** screen.

# EVENT COUNTERS

A Category 1 Event Counter is provided on the 825 with two counters that increment when a change is made to features that are required by NTEP or OIML to be sealed. One counter is designated for calibration parameters and one is designated for configuration changes as required in NCWM Publication 14, 2007. Each event counter has a capacity to record 999 changes. The data for the counters is maintained in non-volatile memory and can be viewed by a weights and measures inspector. When selected, the display will show the number of changes and the date and time of the last update to the Calibrate and Config counters.

## To View the Event Counters

1. Press the **ON/OFF** key to turn on the 825. A self-test will be performed showing the software versions and status of the option cards and then display the Startup screen.

```
CARDINAL 825
Item          Version  03 cards  IIIIIIIIIII
Main board    1.20.003 Slot Type  Version
Loader        1.09.004  1  SIB   1.07.000
OS/Std Apps  1.12.009  2  SIB   1.07.000
              3  DIO   0.05.000

Press:
1. Application program
2. Standard indicator
3. Legal metrology information / Setup
MAC Address: 00:CF:53:29:CF:01
```

2. Press the Navigation Keys  $\nabla$  Down Arrow to “advance” to (highlight) the **Legal metrology information / Setup** option and then press the **ENTER** key or press the **3** key to select the **Legal metrology information / Setup** option. The display will change to show the **Legal metrology information / Setup** screen.

```
Legal metrology information / Setup
Press:
1. View event counters
2. View certifications / ID information
3. Setup menu

MAC Address: 00:CF:53:29:CF:01
```

## EVENT COUNTERS, CONT.

3. With the Legal metrology information / Setup displayed, press the **1** key or press the **ENTER** key. The display will change to show the **Event Counters** screen.

Event Counters				
	Count	Last Update Date	Time	
Calibrate	1	10/26/2010	03:21:23	p.m.
Config	2	10/26/2010	03:20:38	p.m.
Press any key or 'P' to print				

4. After viewing the Event Counters, press the **P** key to print the counters (using COM1 at the default baud rate) or press any key to return to the **Legal metrology information / Setup** screen.

### Return to Normal Operations

To return to the Weight Screen and resume normal weighing operations, with the Legal metrology / Setup screen displayed, press the Navigation Keys **◀** Left Arrow to return to the Startup screen.

CARDINAL 825				
Item	Version	03 cards	IIIIIIIIIIII	
Main board	1.20.003	Slot	Type	Version
Loader	1.09.004	1	SIB	1.07.000
OS/Std Apps	1.12.009	2	SIB	1.07.000
		3	DIO	0.05.000
Press:				
<b>1. Application program</b>				
2. Standard indicator				
3. Legal metrology information / Setup				
MAC Address: 00:CF:53:29:CF:01				

# CERTIFICATIONS / ID INFORMATION

## To View the Certifications / ID Information

1. Press the **ON/OFF** key to turn on the 825. A self-test will be performed showing the software versions and status of the option cards and then display the Startup screen.

```
CARDINAL 825
Item          Version  03 cards  IITTTTTTTTTT
Main board    1.20.003 Slot  Type   Version
Loader        1.09.004  1     SIB    1.07.000
OS/Std Apps  1.12.009  2     SIB    1.07.000
              3     DIO    0.05.000

Press:
1. Application program
2. Standard indicator
3. Legal metrology information / Setup
MAC Address: 00:CF:53:29:CF:01
```

2. Press the Navigation Keys  $\nabla$  Down Arrow to “advance” to (highlight) the **Legal metrology information / Setup** option and then press the **ENTER** key or press the **3** key to select the **Legal metrology information / Setup** option. The display will change to show the **Legal metrology information / Setup** screen.

```
Legal metrology information / Setup
Press:
1. View event counters
2. View certifications / ID information
3. Setup menu

MAC Address: 00:CF:53:29:CF:01
```

3. With the **Legal metrology information / Setup** displayed, press the **2** key to select **View certifications / ID information** or press the  $\nabla$  Down Arrow and then the **ENTER** key to select **View certifications / ID information**. The display will change to show the **Certifications / ID Information** screen.



## CERTIFICATIONS / ID INFORMATION, CONT.

```
Certifications / ID Information
NTEP certificate:    08-046
CANADA certificate: AM-5700C
OIML certificate:   DK0199.160

Serial Number:
Sales Order:
Press any key

MAC Address: 00:CF:53:29:CF:01
```

5. After viewing the Certifications / ID Information, press any key to return to the **Legal metrology information / Setup** screen.

### Return to Normal Operations

To return to the Weight Screen and resume normal weighing operations, with the Legal metrology / Setup screen displayed, press the Navigation Keys ◀ Left Arrow to return to the Startup screen.

```
CARDINAL 825
Item          Version  03 cards  TTTTTTTTTT
Main board   1.20.003 Slot Type  Version
Loader       1.09.004  1   SIB    1.07.000
OS/Std Apps  1.12.009  2   SIB    1.07.000
              3   DIO    0.05.000

Press:
1. Application program
2. Standard indicator
3. Legal metrology information / Setup
MAC Address: 00:CF:53:29:CF:01
```

# ELECTRONIC TALLEY ROLL (ETR) FILE

The 825 is equipped with an Electronic Talley Roll (ETR) file, which stores transaction data each time the indicator receives a Talley command from the computing peripheral. The data is maintained in non-volatile memory for viewing by a weights and measures inspector.

Each time the indicator receives an ETR request (SMA XT command), an internal consecutive transaction number (that cannot be modified), the date, time, and the current weight will be stored in memory. The 825 has memory capacity to store up to 7000 transactions in the ETR file. Note that when its capacity is reached, the newest transaction will replace the oldest.

## To View the Electronic Talley Roll (ETR) File

1. Press the **ON/OFF** key to apply power to the 825. The display will perform a short self-test and then change to the Startup screen showing the software versions and diagnostics of the option cards.
2. When the 825 is initially started, a countdown starting at 7 seconds will appear to the right of 1. **Application Program**. Allow the countdown to complete or press the **ENTER** key or press the **1** key to select the **Application Program** option. The display will change to show:

Starting application mode

and then change to show:

Loading...

Starting...

and then change to show the **Application Menu** with the countdown seconds appearing to the right of the last menu selection.

Application Menu	OS Version 1.12.009
Truck / <u>I</u> D Storage By Cardinal	DFC <u>B</u> atcher By Cardinal
<u>C</u> heck Weigher By Cardinal	<u>H</u> ighway Weigh Station By Cardinal
<u>M</u> ulti Scale By Cardinal	Multi Scale ( <u>E</u> IP) By Cardinal
IP: 127.0.0.1	<u>N</u> ext >>

# ELECTRONIC TALLEY ROLL (ETR) FILE, CONT.

## Configuration

3. With the Application Menu displayed, press the **NEXT** key or use the Navigation Keys to select (highlight) **Next** and then press the **ENTER** key. The display will change to show the second page of the Application Menu.
4. With the second page of the Application Menu displayed, press the **Configuration** key or use the Navigation Keys to select (highlight) **Configuration** and then press the **ENTER** key. The display will change to show the **Configuration** screen.

Configuration
<u>C</u> alibrate touch screen
Show Touch S <u>c</u> reen Tracking
Set Col <u>o</u> r Settings
Configure <u>W</u> eight Server
<u>T</u> icket Settings
Configure <u>M</u> enu
Set Factory <u>D</u> efaults

## Configure Weight Server

With the Configuration screen displayed, press the **W** key or use the Navigation Keys to select (highlight) **Configure Weight Server** and then press the **ENTER** key. The display will change to show the **Configure Weight Server** screen.

Configure Weight Server
Configure <u>T</u> CP/IP Server
Configure <u>S</u> erial Ports
<u>E</u> lectronic Talley Roll

# ELECTRONIC TALLEY ROLL (ETR) FILE, CONT.

## 3. Electronic Talley Roll

With the Configure Weight Server screen displayed, press the **E** key or use the Navigation Keys to select (highlight) **Electronic Talley Roll** and then press the **ENTER** key. The display will change to show the **Select ETR Range** screen.

### Select ETR Range

#### From:

With the Select ETR Range screen displayed, the setting for **From:** (the ETR range starting number) will be shown. If the number displayed is acceptable, press the  $\nabla$  Down Arrow to proceed to the **To:** parameter.

Otherwise, use the numeric keys to enter the ETR starting number and then press the  $\nabla$  Down Arrow to “advance” to the **To:** parameter.

#### To:

With the Select ETR Range screen displayed, the setting for **To:** (the ETR range ending number) will be shown. If the number displayed is acceptable, press the **ENTER** key to proceed to the **ETR Report** screen.

Otherwise, use the numeric keys to enter the ETR ending number and then press the **ENTER** key to proceed to the **ETR Report** screen.

#### Output:

With the Select ETR Range screen displayed, the current setting for the **Output:** parameter will be shown. If the setting displayed is acceptable, press the **ENTER** key to proceed to the **ETR Report** screen.

Otherwise, press the **SPACE** key to toggle its status (select View or Print).

If Print is selected, press the  $\nabla$  Down Arrow to advance to the next parameter and then press the **SPACE** key to select the Output port. Available output ports are:

<b>COM1-RS232</b>	<b>COM1-Bluetooth</b>	<b>COM2</b>
<b>COM3</b>	<b>USB-PRT1</b>	<b>USB-PRT2</b>
<b>USB-PRT3</b>	<b>USB-PRT4</b>	<b>USB-PRT5</b>
<b>USB-PRT6</b>		

When the desired output port has been selected, press the **ENTER** key to proceed to the **ETR Report** screen.

# ELECTRONIC TALLEY ROLL (ETR) FILE, CONT.

## ETR Report

After viewing the ETR Report for the number or range of numbers entered, press any key to return to the **Select ETR Range** screen.

<b>ETR Report</b>			
<b>Num</b>	<b>Date</b>	<b>Time</b>	<b>Weight</b>
<b>Press any key</b>			

## Return to Normal Operations

To return to the Weight Screen and resume normal weighing operations, with the **Select ETR Range** screen displayed, press the Navigation Keys **◀** Left Arrow three (3) times to return to the **Application Menu**.

<b>Application Menu</b>		<b>OS Version 1.12.009</b>
<b>Truck / <u>I</u>D Storage By Cardinal</b>		<b>DFC <u>B</u>atcher By Cardinal</b>
<b><u>C</u>heck Weigher By Cardinal</b>		<b><u>H</u>ighway Weigh Station By Cardinal</b>
<b><u>M</u>ulti Scale By Cardinal</b>		<b>Multi Scale (<u>E</u>IP) By Cardinal</b>
<b>IP: 127.0.0.1</b>		<b><u>N</u>ext &gt;&gt;</b>

With the Application Menu displayed, press the number key of the application to run or use the Navigation Keys to select (highlight) the application to run and then press the **ENTER** key. The display will change to show the Weight screen. Normal weighing operations can now resume.

# LEAD AND WIRE SECURITY SEAL INSTALLATION

If your Model 825 indicator is used in a commercial application and your local metrology laws require the use of physical sealing, a lead and wire security seal can be installed to prevent the rear panel from being removed from the indicator. Refer to the Figure No. 24 for a suggested location and details on the installation of the security seal.

**NOTE:** In order to install the lead and wire security seal, two (2) acorn nuts on the rear panel MUST be replaced with drilled acorn nuts. They are available from the Cardinal Scale Mfg. Parts Department. The part number is 8200-B026-08 (NUT HEX #10-32 ACORN SS DRILLED).

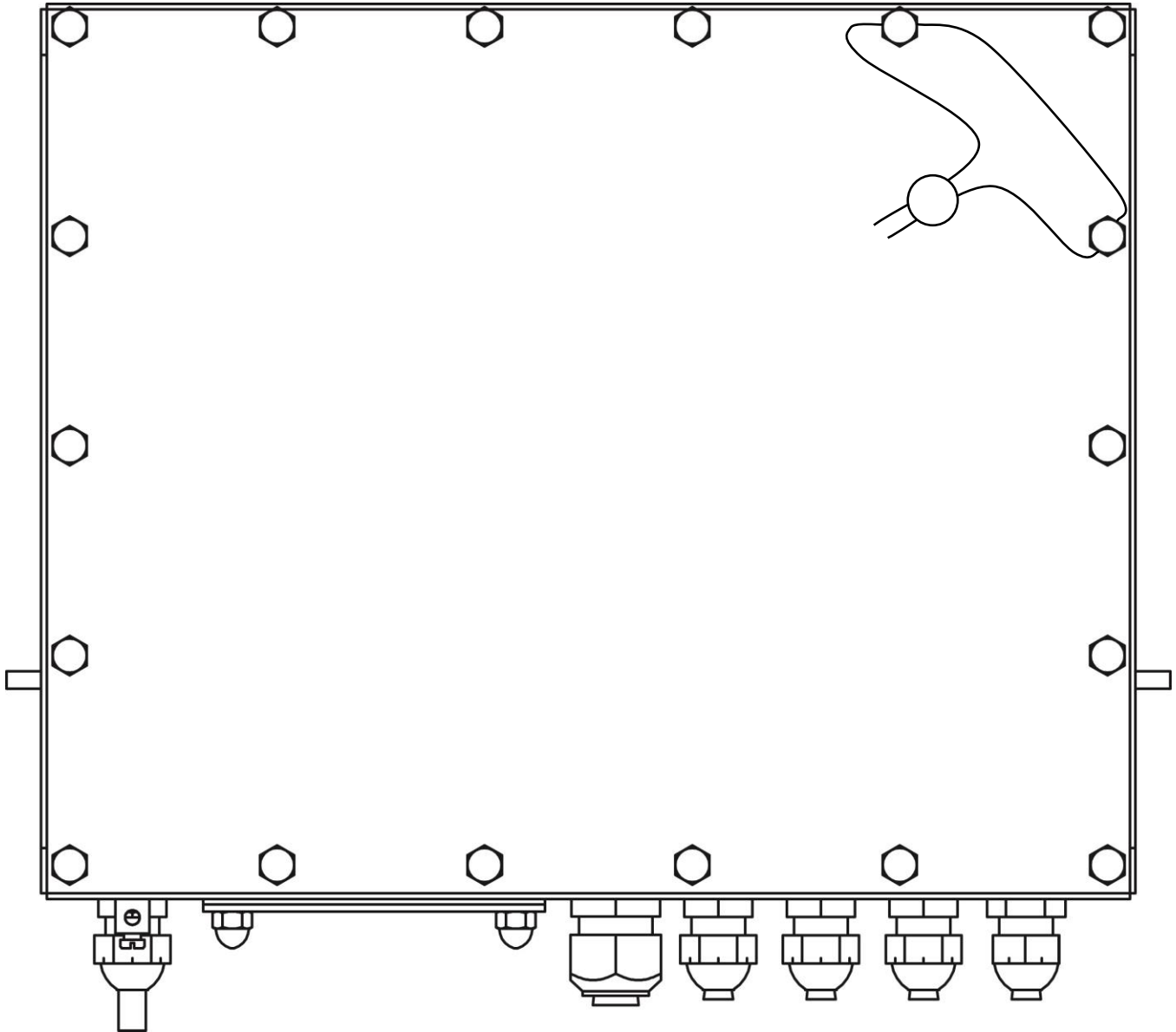
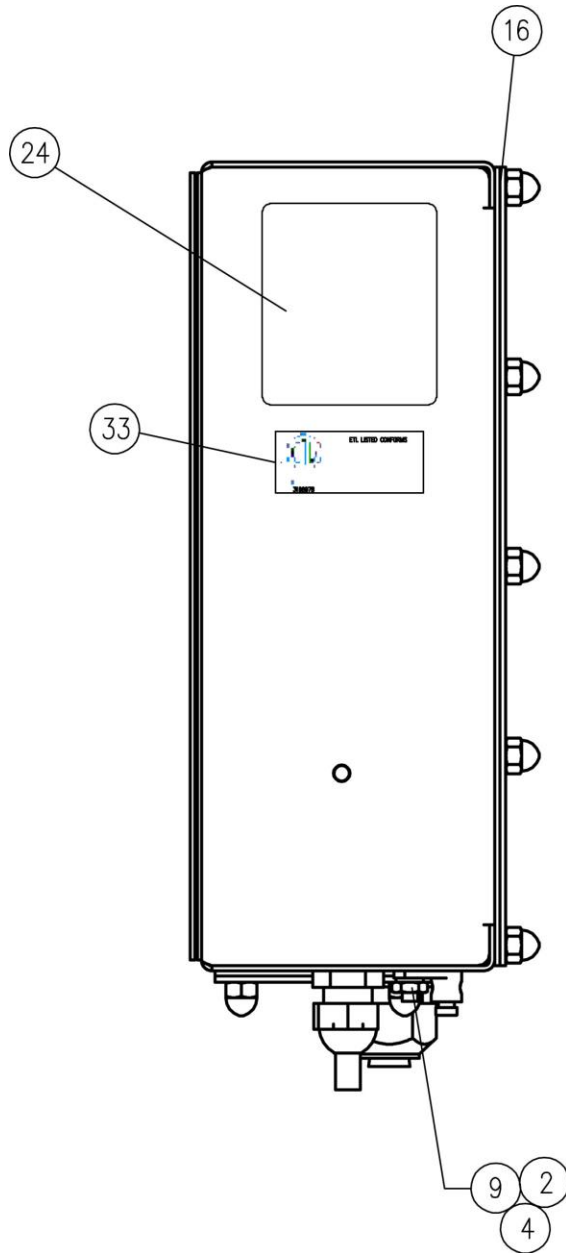

Figure No. 24

## PART IDENTIFICATION (Side View)



ITEM #	QTY.	PART NUMBER	DESCRIPTION
2	1	6013-0297	NUT #10-32 HEX
4	1	6024-0037	WASHER LOCK HELICAL SP #10 REG SS
9	1	6610-5002	GROUND LUG L-35
16	1	8545-C860-08	825 GASKET SET
24	1	593GR986	SERIAL TAG ASSY.
33	1	5930-B124-08	LABEL: ETL FOR 825

## PART IDENTIFICATION (Front View)

ITEM #	QTY.	PART NUMBER	DESCRIPTION
12	1	6980-1030	POWER CORD 18/3 SJTW CEE 6.3 FT.
17	1	8545-C822-0A	BEZEL WELDMENT
20	1	8545-D810-08	KEYPAD: 825 INDICATOR
24	1	593GR986	SERIAL TAG ASSY.
27	1	6980-0250	POWER CORD EURO (
28	1	8545-D853-08	KEYPAD: C.A.T. INDICATOR



# PART IDENTIFICATION

(Front View)

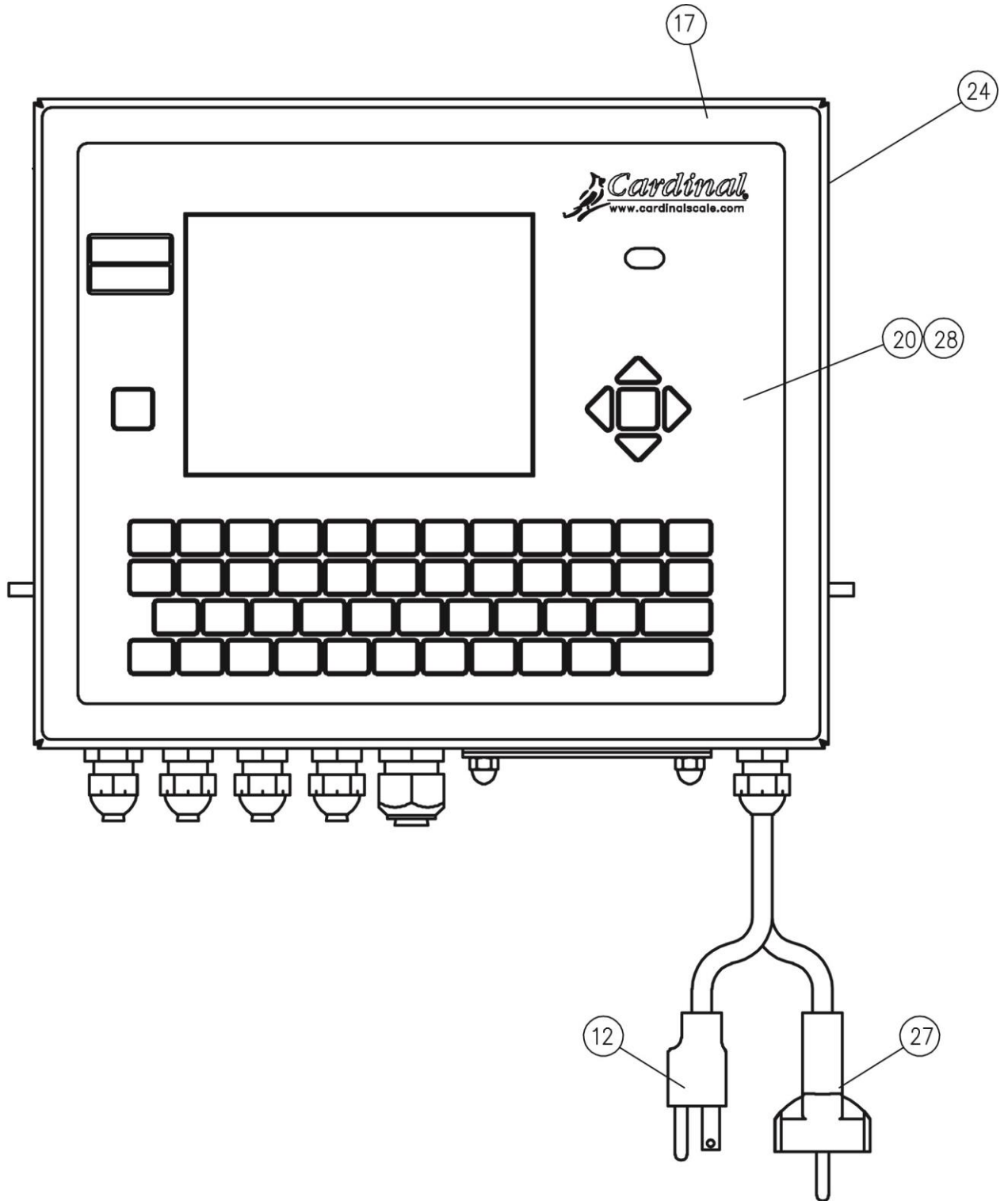

# PART IDENTIFICATION

(Rear – Inside View)

ITEM #	QTY.	PART NUMBER	DESCRIPTION
1	26	6013-0039	NUT #6-32 HEX
5	10	6024-1022	WASHER FLAT #6 Z/P
6	14	6024-1078	WASHER FLAT #6 NEOPRENE BACKING SS
10	12	6680-0004	WASHER LOCK INT TOOTH #6 TYPE A Z-PL
11	4	6680-0220	SPACER #6 x .875 NYLON
18	1	8545-C834-0A	POWER SUPPLY ASSEMBLY
19	1	8545-D835-1A	SUB-CHASSIS ASSEMBLY – LED
26	1	6610-5084	TERMINAL BLOCK, 3 POS.

# PART IDENTIFICATION

(Rear – Inside View)

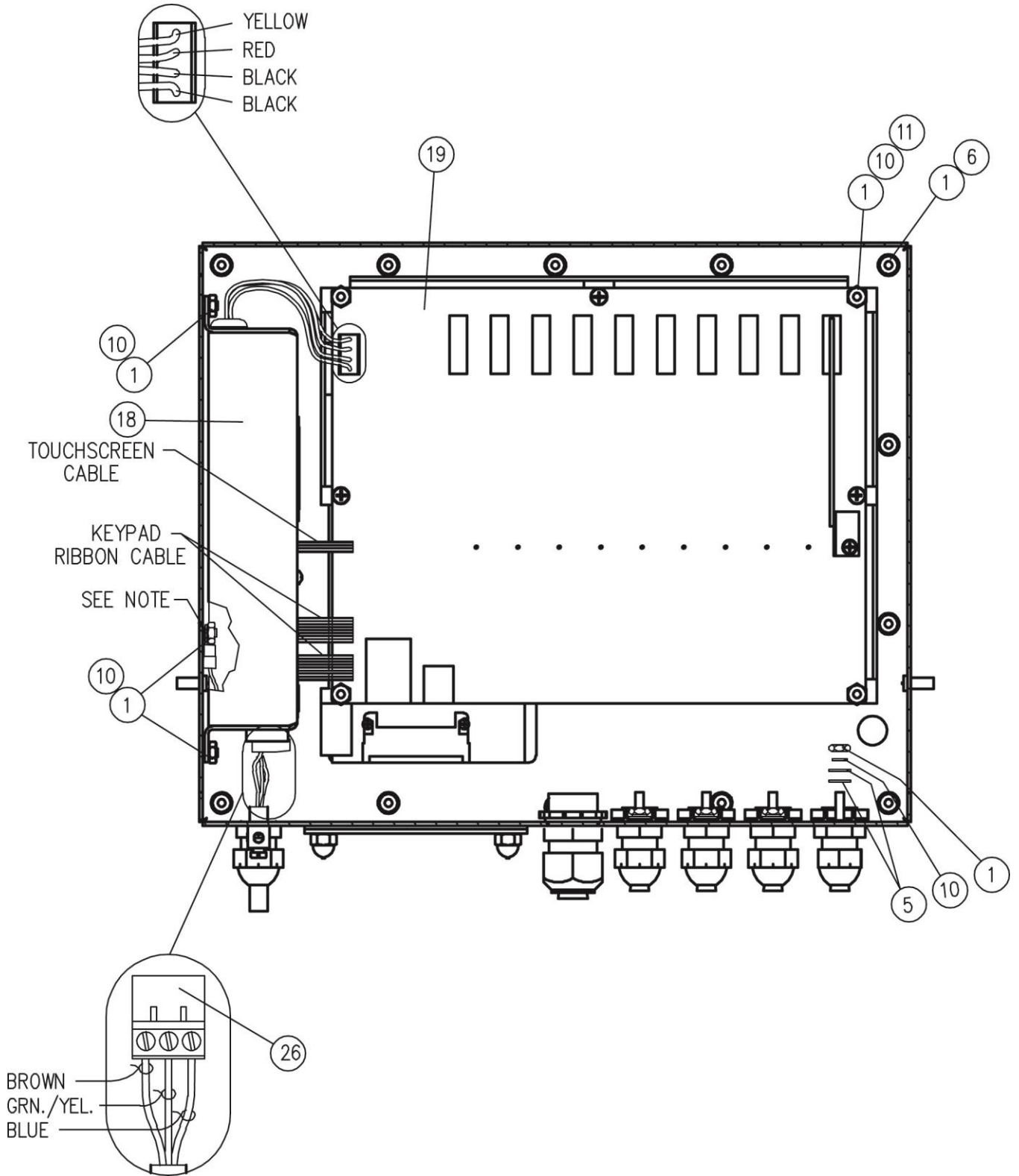

**NOTE:** The ground wire for the power supply is attached to the enclosure wall at the ground lug located under the power supply housing as show.

## PART IDENTIFICATION

**(ITEM # 19, 8545-D835-1A, SUB-CHASSIS ASSEMBLY – LED)**

ITEM #	QTY	PART NUMBER	DESCRIPTION
1	3	6021-0004	SCW PAN-HEAD.. MACHINE-SCW 02-56X.5625
2	4	6021-0409	SCW ROUND-HEAD MACHINE-SCW 04-40X.312
3	1	6021-0423	SCW PAN-HEAD.. MACHINE-SCW 04-40X.250
4	3	6021-0654	SCW PAN-HEAD.. MACHINE-SCW 06-32X.250
5	*	6560-0005	TAPE DBL SIDED 1.0" WIDE 10 MIL THICK
6	2	6610-1218	CABLE CLIP, 1/2"X1/2" ADHESIVE BACKED
7	1	6645-2254	DISPLAY LCD GRAPHIC TFT 6.5", 640*480 LED
8	3	6680-0004	WASHER LOCK INT TOOTH #6 TYPE A Z-PL
9	3	6680-0084	WASHER LOCK HELICAL SP #2 REG Z-PL
10	5	6680-0026	WASHER LOCK INT TOOTH #4 TYPE A Z-PL
11	3	6680-1109	SPACER # 2 X 0.125 ROUND NYLON
12	1	8545-B847-0A	PCB ASS'Y 825 LED BACKLIGHT CONTROLLER
13	1	8545-D801-0A	PCB: OPERATOR INTERFACE, 825 INDICATOR
14	1	8545-C803-0A	PCB: SCALE INPUT, 825 INDICATOR
15	1	8545-D800-0A	PCB: CONTROLLER, 825 INDICATOR
16	1	8545-D802-08	BOARD MOUNT BRACKET
17	1	8545-B812-08	BACKLIGHT INVERTER CABLE

# PART IDENTIFICATION

(ITEM # 19, 8545-D835-1A, SUB-CHASSIS ASSEMBLY – LED)

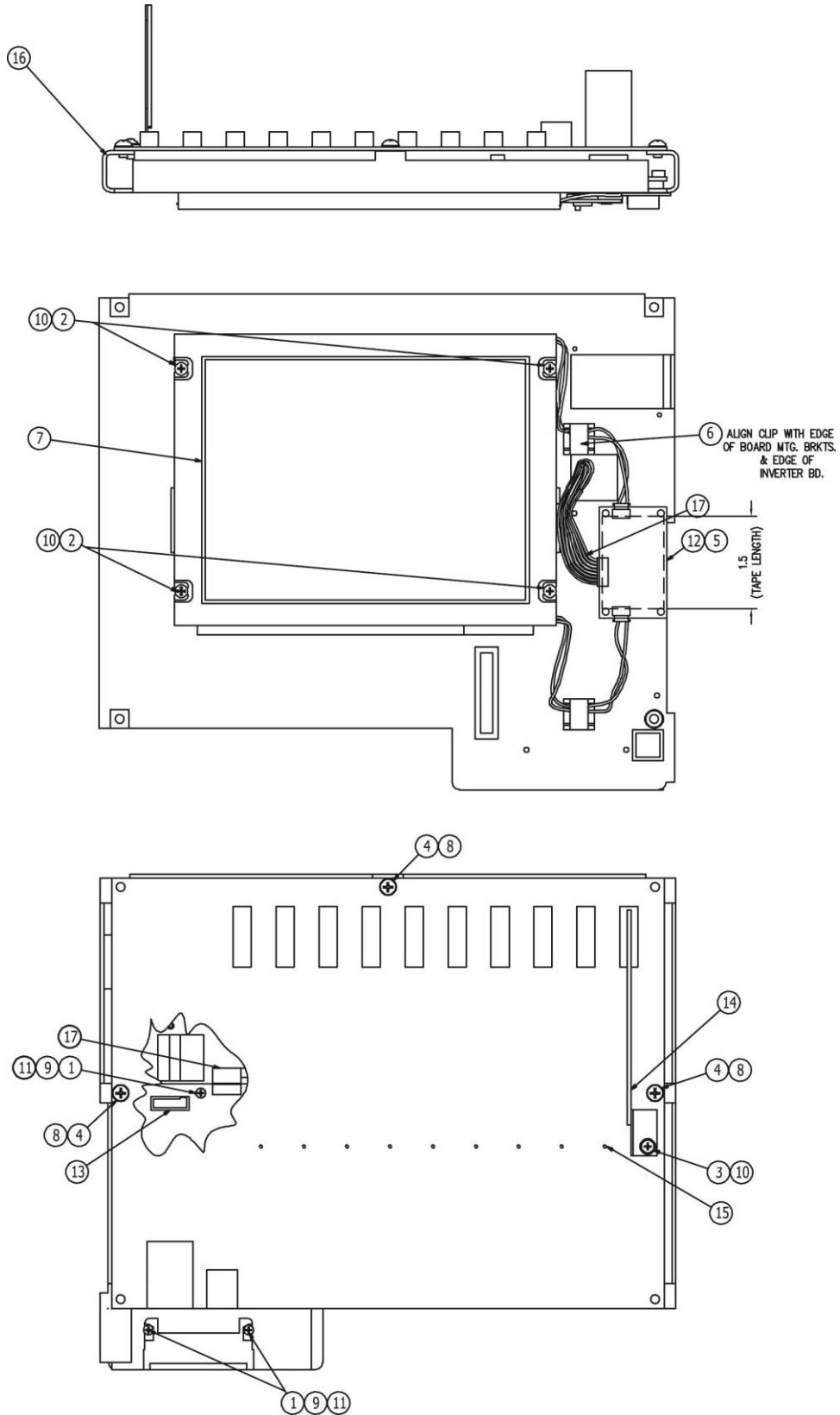

## PART IDENTIFICATION (Mounting Touch Screen Cable)

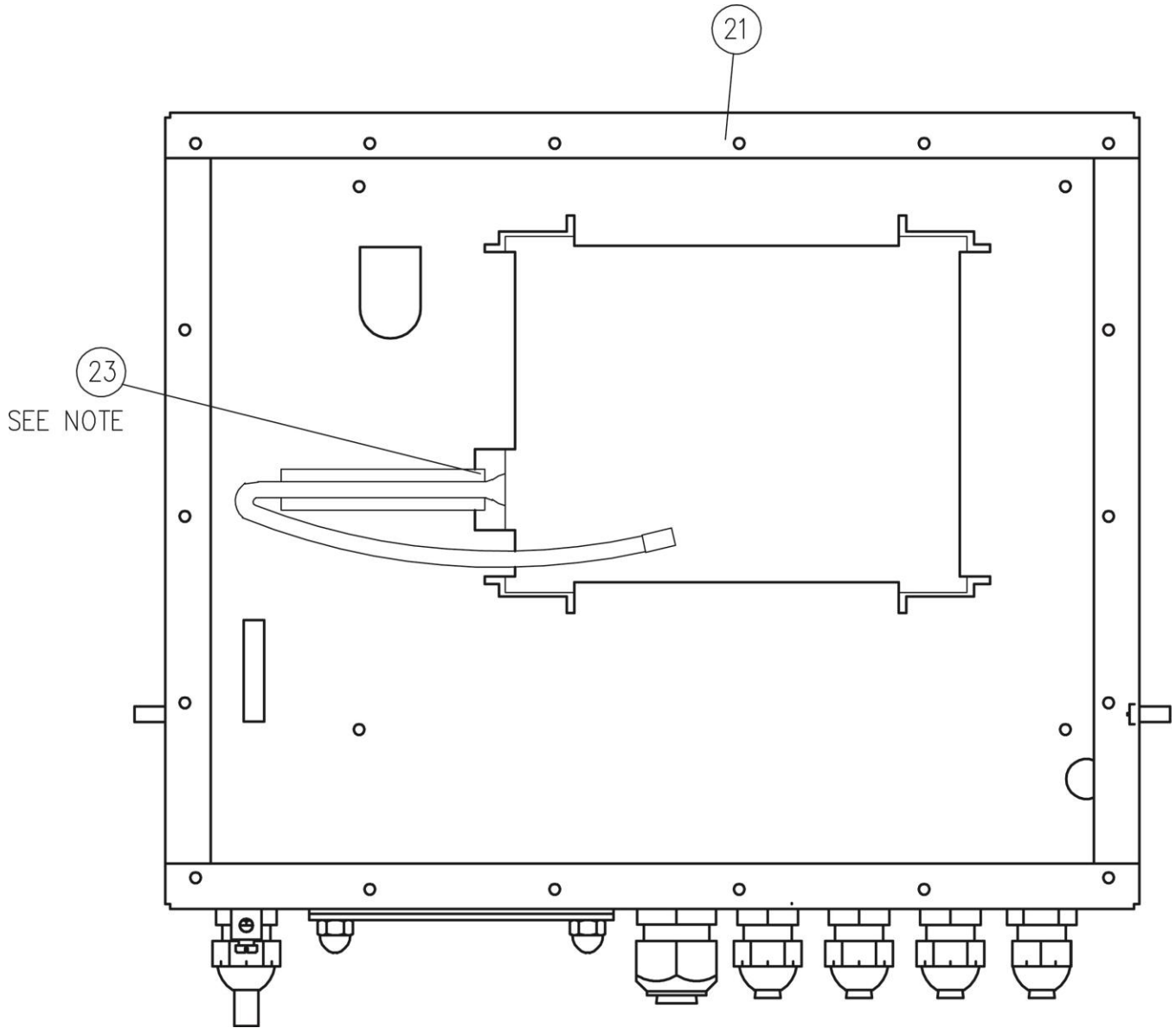

**NOTE:** Tape must extend past the edge of enclosure as shown.

ITEM #	QTY.	PART NUMBER	DESCRIPTION
21	1	8545-D897-0A	FRONT ENCLOSURE WELDMENT
23	*	6710-0030	TAPE, DBL. SIDED 0.5" WIDE

## PART IDENTIFICATION (Bottom View)

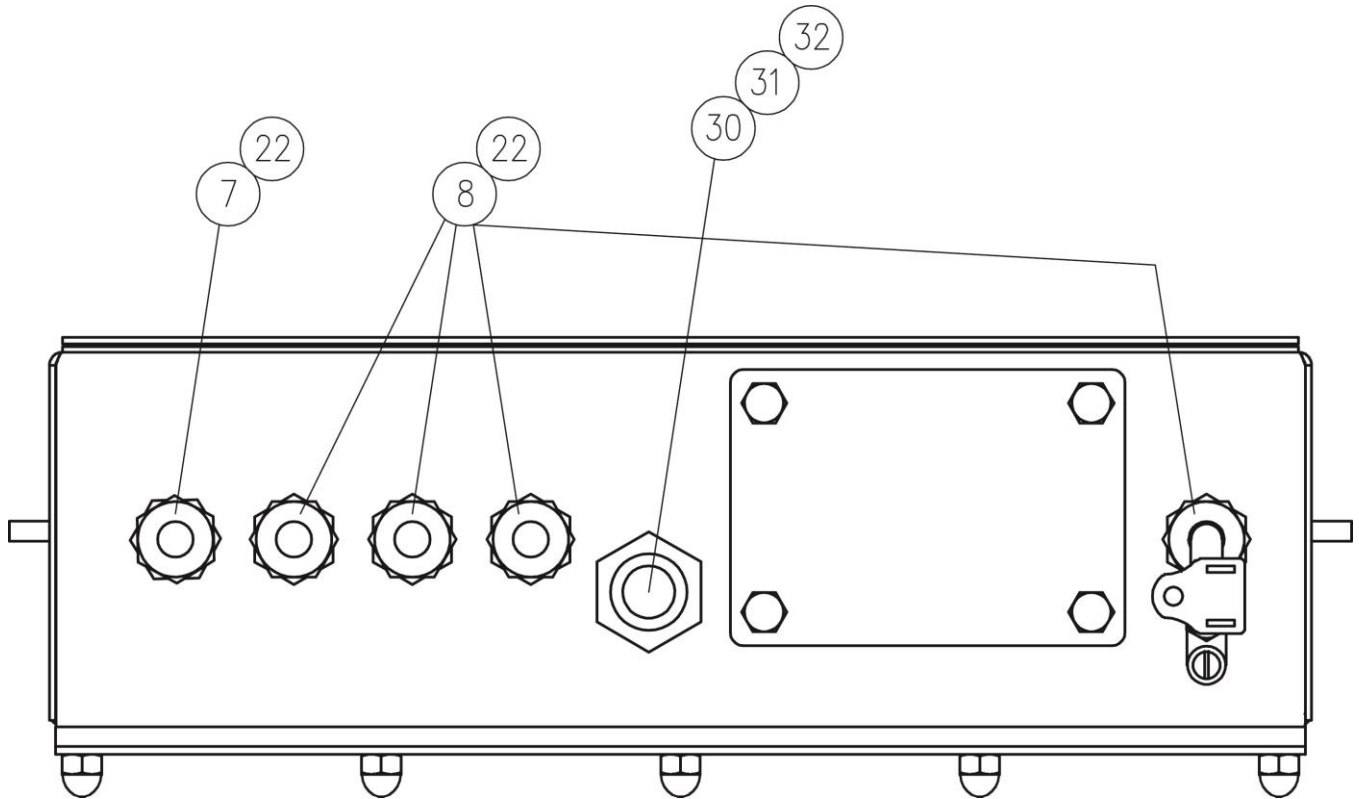

ITEM #	QTY.	PART NUMBER	DESCRIPTION
7	1	6610-1506	CONN GLAND .160-.310 GRIP .60 MTG NICKEL
8	4	6610-2248	CONN GLAND .187-.312 GRIP .599 MTG BLK
22	4	6540-1104	HOLE PLUG, 0.173-0.240
30	1	6560-0311	PLUG RUBBER 734506
31	1	6610-2081	CONN GLAND .179-.470 GRIP .875 MTG BLK
32	1	6910-0171	NUT CONDUIT 1/2 LOCK

## PART IDENTIFICATION (Rear View)

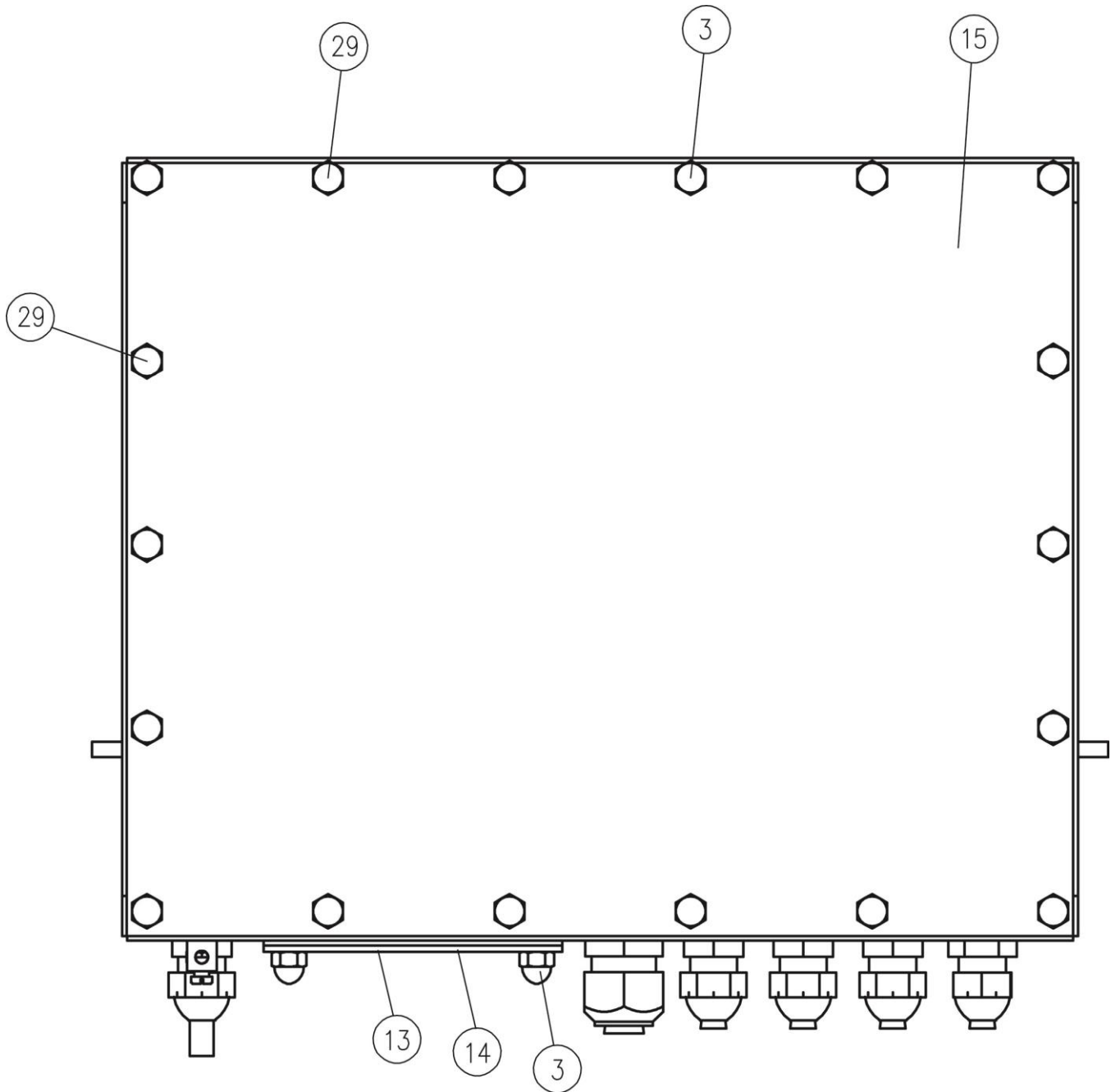

ITEM #	QTY.	PART NUMBER	DESCRIPTION
3	16	6013-0433	NUT #10-32 HEX ACORN LOCK SS
13	1	8545-B813-08	ACCESS PLATE
14	1	8545-C860-08	825 GASKET SET
15	1	8545-C896-08	REAR PANEL
29	2	8200-B026-08	NUT #10-32 HEX ACORN LOCK, DRILLED, SS



# STATEMENT OF LIMITED WARRANTY

## WARRANTY TERMS

Cardinal Scale Manufacturing Company warrants the equipment we manufacture against defects in material and workmanship. The length and terms and conditions of these warranties vary with the type of product and are summarized below:

PRODUCT TYPE	TERM	MATERIAL AND WORKMANSHIP	LIGHTNING DAMAGE See note 9	WATER DAMAGE See note 7	CORROSION See note 4	ON-SITE LABOR	LIMITATIONS AND REQUIREMENTS
<b>WEIGHT INDICATORS</b>	90 DAY REPLACEMENT ----- 1 YEAR PARTS	YES	YES	YES	YES	NO	1, 2, 3, 5, 6 A, B, C, D
<b>LOAD CELLS</b> (Excluding Hydraulic)	1 YEAR	YES	YES	YES	YES	NO	1, 2, 3, 5, 6 A, B, C, D
<b>HYDRAULIC LOAD CELLS</b> (When purchased with Guardian Vehicle Scale)	LIFE	YES	YES	YES	YES	90 DAYS	1, 5, 6, 8 A, B, C, D
<b>HYDRAULIC LOAD CELLS</b> (When purchased separately)	10 YEARS	YES	YES	YES	YES	NO	1, 5, 6, 8, 9 A, B, C, D
<b>VEHICLE SCALE</b> (Deck and Below Excl. PSC Series)	5 YEARS	YES	YES	YES	YES	90 DAYS	1, 2, 3, 5, 6 A, B, C, D, E
<b>PSC and LSC SCALE STRUCTURES</b> (Deck and Below)	3 YEARS	YES	YES	YES	YES	90 DAYS	1, 2, 3, 5, 6, 11 A, B, C, D
<b>GUARDIAN FLOOR SCALES</b>	10 YEARS	YES	YES	YES	YES	NO	1, 2, 3, 5, 6, 9, 10 A, B, C, D
<b>ALL OTHER CARDINAL PRODUCTS</b>	1 YEAR	YES	YES	YES	YES	NO	1, 2, 5, 6 A, B, C, D, E
<b>REPLACEMENT PARTS</b>	90 DAYS	YES	YES	YES	YES	NO	1, 2, 4, 5, 6 A, B, C, D
<b>IN-MOTION VEHICLE SCALES</b>	1 YEAR	YES	YES	YES	YES	90 DAYS	1, 2, 5, 6 A, B, C, D
<b>SOFTWARE</b>	90 DAYS	YES	N/A	N/A	N/A	NO	1, 6 B, C, D



Ph. (800) 441-4237  
 E-mail: cardinal@cardet.com  
 203 E. Daugherty  
 Webb City, MO 64870

06/13  
 Printed in USA  
 315-WARRANTY-CAR-K

## APPLICABLE LIMITATIONS AND REQUIREMENTS

1. This warranty applies only to the original purchaser. The warranty does not apply to equipment that has been tampered with, defaced, damaged, or had repairs or modifications not authorized by Cardinal or has had the serial number altered, defaced or removed.
2. This warranty is not applicable to equipment that has not been grounded in accordance with Cardinal's recommendations.
3. This equipment must be installed and continuously maintained by an authorized Cardinal dealer.
4. Applies only to components constructed from stainless steel.
5. This warranty does not apply to equipment damaged in transit. Claims for such damage must be made with the responsible freight carrier in accordance with freight carrier regulations.
6. Warranty term begins with date of shipment from Cardinal.
7. Only if device is rated NEMA 4 or better or IP equivalent.
8. Lifetime warranty applies to damages resulting from water, lightning, and voltage transients and applies only to the hydraulic load cell structure itself (does not include pressure transducers, rubber seals, o-rings, and associated wiring).
9. 10 Year prorated warranty on hydraulic load cells.
10. 1 Year warranty for scale structure.
11. PSC models' warranty coverage applies only to agricultural installations on farms up to 3,000 acres (LSC models not limited in this manner).
12. Load cell kits MUST be installed in accordance with Cardinal Scale instructions. Failure to follow these instructions will void the warranty.

## EXCLUSIONS

- A.) This warranty does not include replacement of consumable or expendable parts. The warranty does not apply to any item that has been damaged due to unusual wear, abuse, improper line voltage, overloading, theft, fire, water, prolonged storage or exposure while in purchaser's possession or acts of God unless otherwise stated herein.
- B.) This warranty does not apply to peripheral equipment not manufactured by Cardinal. This equipment will normally be covered by the equipment manufacturer's warranty.
- C.) This warranty sets forth the extent of our liability for breach of any warranty or deficiency in connection with the sale or use of our product. Cardinal will not be liable for consequential damages of any nature, including but not limited to loss of profit, delays or expenses, whether based on tort or contract. Cardinal reserves the right to incorporate improvements in material and design without notice and is not obligated to incorporate said improvements in equipment previously manufactured.
- D.) This warranty is in lieu of all other warranties expressed or implied including any warranty that extends beyond the description of the product including any warranty of merchantability or fitness for a particular purpose. This warranty covers only those Cardinal products installed in the forty-eight contiguous United States and Canada.
- E.) This warranty does not cover paint coatings due to the variety of environmental conditions.
- F.) Do not cut load cell cables on load cells returned for credit or warranty replacement. Cutting the cable will void the warranty.
- G.) Software is warranted only for performance of the functions listed in the software manual and/or the Cardinal proposal.
- H.) The software warranty does not cover hardware. Warranties on hardware are provided from the hardware vendor only.
- I.) The software warranty does not cover interfacing issues to non-Cardinal supplied hardware.
- J.) The software warranty does not include automatic software upgrades unless purchased separately.



Ph. (800) 441-4237  
E-mail: cardinal@cardet.com  
203 E. Daugherty  
Webb City, MO 64870

06/13  
Printed in USA  
315-WARRANTY-CAR-K



