



SMARTCELL[®]
DIGITAL LOAD CELLS

**SCBD Digital
Load Cell Kit
Technical Manual**

TABLE OF CONTENTS

INTRODUCTION AND INSTALLATION INSTRUCTIONS

INTRODUCTION	1
INSTALL LOAD CELL STANDS	2
INSTALLING LOAD CELL CABLES	3

HOMERUN CABLE INSTALLATION

Homerun Cable Installation	5
Power DLC to Scale Connection	7
Power DLC to Indicator DLC Card Connection	8
Re-Installing the Power DLC Cover	8
Power DLC to 225D Indicator Connection	9
225DLC Card ICAN Jumpers	11
Re-Installing the 225D Indicator Rear Panel	11
Power DLC to 825D Indicator Connection	12
825DLC Card ICAN Jumpers	14
Re-Installing the 825D Indicator Rear Panel	14
Load Cell to Power DLC Connection	15

GROUNDING INSTRUCTIONS

Grounding Specifications – 3502-0671-GS	18
SCBD Load Cell Scale Grounding Specifications – 3502-0713-GS	19
Grounding Instructions for SCBD Load Cell Scales	20
Site Requirements	20
Indicator and Scale Lightning Protection Connections	20
Scale Ground Stud to Ground Rod Connections	21

SCALE SETUP AND CONFIGURATION

Digital Scale Setup and Configuration	22
To Begin 225D Setup and Configuration	23
Addressing Cells	23
End Nodes	23
225D Calibration	24
Navigating to the DLC Calibration Menu	24
Smart Calibration	25
Zero Calibration	25
Trim Cells	26
Span Adjust	26

TABLE OF CONTENTS, CONT.

SCALE SETUP AND CONFIGURATION, CONT.

To Begin 825D Setup and Configuration	27
Login	28
Setup Scale Number	29
Setup DLC Card 1	30
DLC Card 1 Cell Assignment	31
Smart Calibration	35
Zero Calibration	44
Trim Cells	47
Span Adjust	53

WEIGHBRIDGE DEAD LOAD

BALANCING WEIGHBRIDGE DEAD LOAD	56
---------------------------------------	----

DIGITAL SCALE DIAGNOSTICS

225D DIGITAL SCALE DIAGNOSTICS	57
On Screen Diagnostics	57
Diagnostic Menu	62
Hardware Diagnostics	66
DETECTING 225D BOARD REPLACEMENTS	67
225DLC Digital Controller Card Replacement	68
225DLC Controller (Digital Scale) Card	70
825D DIGITAL SCALE DIAGNOSTICS	73
On Screen Diagnostics	73
Diagnostic Menu	77
Hardware Diagnostics	89
DETECTING 825D BOARD REPLACEMENTS	90
825-DLC Digital Controller Card Replacement	92
825DLC Controller (Digital Scale) Card	94

TROUBLESHOOTING GUIDE

DISPLAYED ERROR MESSAGES	95
REPLACE LOAD CELL X	95
LOAD VOLTAGE DETECTED CELL X	95
CURRENT DRAW IS MORE THAN 150% OF CAPACITY	97
LOAD CELL X NOT RESPONDING	98
COMMUNICATIONS ERROR BETWEEN INDICATOR AND SCALE	98
LOAD CELL X HAS NO ADDRESS	100

TABLE OF CONTENTS, CONT.

TROUBLESHOOTING GUIDE, CONT.

COMMUNICATION ERROR BETWEEN LOADCELLS X AND Y	100
SCALE WILL NOT RETURN TO ZERO	100
SCALE IS UNSTABLE	100
LOAD CELL OR SCALE COMMUNICATION PROBLEMS	101

PARTS IDENTIFICATION

axis® Stand Components, Load Cell, Pivot Plates, Cables	102
Connectors, POWER-DLC, Digital Load Cell Controller Cards	103

Copyright

All rights reserved. Reproduction or use, without expressed written permission, of editorial or pictorial content, in any manner, is prohibited. No patent liability is assumed with respect to the use of the information contained herein.

Disclaimer

While every precaution has been taken in the preparation of this manual, the Seller assumes no responsibility for errors or omissions. Neither is any liability assumed for damages resulting from the use of the information contained herein. All instructions and diagrams have been checked for accuracy and ease of application; however, success and safety in working with tools depend largely upon the individual accuracy, skill, and caution. For this reason, the Seller is not able to guarantee the result of any procedure contained herein. Nor can they assume responsibility for any damage to property or injury to persons occasioned from the procedures. Persons engaging in the procedures do so entirely at their own risk.

FCC Compliance Statement

This equipment generates uses, can radiate radio frequency, and if not installed and used in accordance with the instruction manual, may cause interference to radio communications. It has been designed within the limits for a Class A computing device pursuant to Subpart J of Part 15 of FCC rules to provide reasonable protection against such interference when operated in a commercial environment. Operation of this equipment in a residential area may cause interference in which case the user will be responsible to take whatever measures necessary to correct the interference.

You may find the booklet "How to Identify and Resolve Radio-TV Interference Problems" prepared by the Federal Communications Commission helpful. It is available from the U.S. Government Printing Office, Washington, D.C. 20402. Request stock No. 001-000-00315-4.

Serial Number _____

Date of Purchase _____

Purchased From _____

RETAIN THIS INFORMATION FOR FUTURE USE

PRECAUTIONS

Before using this product, read this manual and pay special attention to all "NOTIFICATION" symbols:



DANGER!
WARNING!
CAUTION!

INTRODUCTION

Cardinal Scale's SCBD Load Cell kit provides you with the components necessary for the construction of a digital scale for optimum vehicle weighing. Whether the scale is designed to be installed above ground or in a pit, all components can be installed from the top through small access covers. The SCBD Load Cell Kit utilizes Cardinal Scale's SCBD SmartCell® digital load cells and axis® heavy duty load cell stands with Frictionless Centering. Shielded PVC cabling is available for enhanced rodent protection throughout the scale.



This manual should be studied thoroughly before attempting to install the digital truck scale and must be used in conjunction with certified drawings of the particular truck scale model being installed.

IMPORTANT! In case of conflict, the certified drawings will govern.

Safety should always be the prime consideration during all phases of the installation. Failure to comply with the instructions in this manual will void all warranty implied or stated.

INSTALL LOAD CELL STANDS

1. After the weighbridge modules are in place, ensure the load cell stands are completely against the concrete pier. If required, tap on the stand to level out against the pier before drilling anchor holes.
2. Drill four 3/4-inch (19 mm) diameter holes for the anchor bolts. The holes should be 10 inches (25 cm) deep for the anchor bolts. To allow the drill to clear the shipping bracket and drill the anchor bolt holes 10 inches (25 cm) deep, a 36-inch (90 cm) drill bit is required.



A 36-inch (90 cm) drill bit is required to clear the access opening when drilling the holes.



Drill 3/4 inch (19 mm) diameter holes 10 inches (25 cm) deep to install the anchor bolts.



IMPORTANT! To ensure the anchor bolt holes are at the correct depth, remove the dust from the holes after drilling is complete. Use a vacuum (with a long nozzle) to vacuum the dust out of the holes.

3. Insert the anchor bolts, and then use an impact wrench to tighten the anchor bolts.



Insert the anchor bolts, and then use an impact wrench to tighten the anchor bolts.

INSTALLING LOAD CELL CABLES

All digital scales using Cardinal Scale's SCBD SmartCell® digital load cells are connected with a daisy-chained CAN (Controller Area Network) cable. The load cell connection loop can begin at any load cell and may continue clockwise as shown or counter-clockwise if preferred. Note that in the example below there is no connection between cells 4 and 6.



IMPORTANT! Be sure to install the end node terminator on the load cell at end of the loop as shown in the example.

Example: Typical Truck Scale Configuration

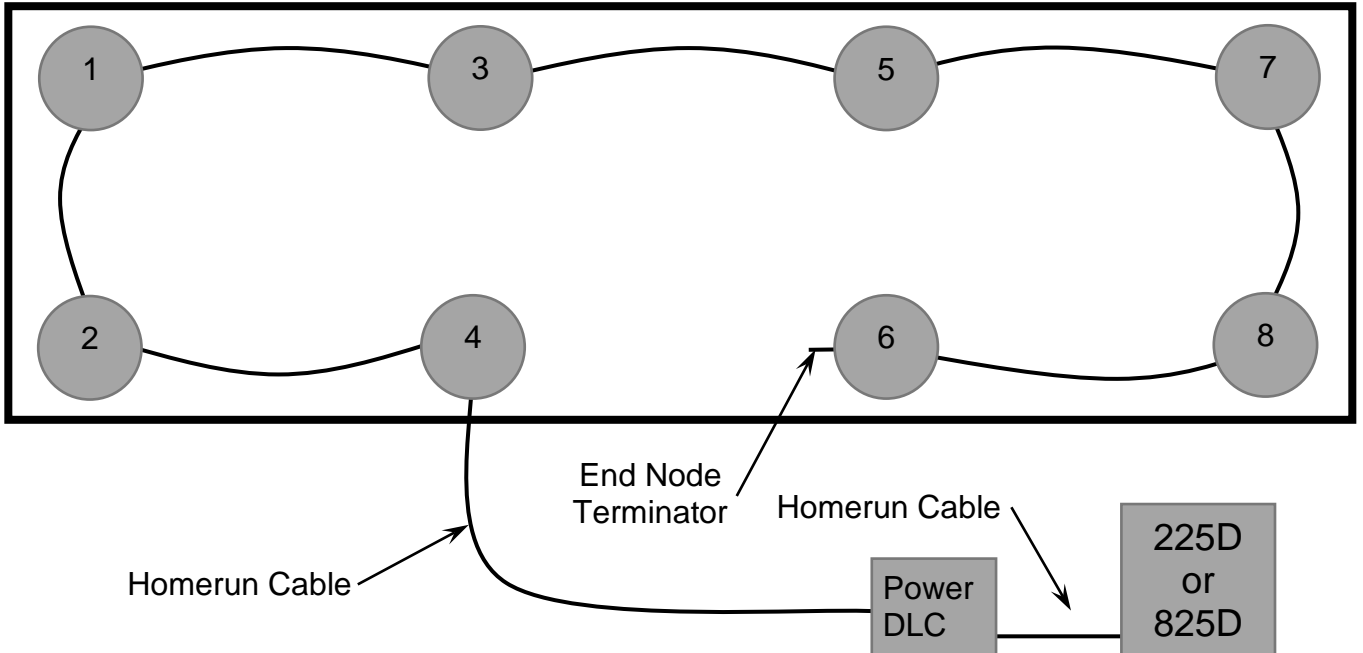

1. Run the load cell cable through conduit installed in bridges between the load cells. Install the load cell cable connectors on the load cell fittings, and hand-tighten the connectors.



Insert the load cell cable into the scale conduit.



Install the load cell cable connectors on the load cell fittings and hand-tighten.

2. Install the End Node Terminator on the last load cell of the connection loop.



Install the End Node Terminator on the last load cell of the connection loop.

HOMERUN CABLE INSTALLATION

Homerun Cable Installation

The homerun cable is made from five conductors, shielded PVC cable. The main (longer) section is connected to the SCALE terminal block in the POWER-DLC, and the load cell end is terminated with a 5-pin actuation lever-type connector from the Home Run Cable Connector Pack. An additional (shorter) section of the homerun cable is connected to the INDICATOR terminal block in the POWER-DLC and the DLC card in the 225D or 825D indicator. Refer to the table below for cable and connector information.

Cable and Connector Information

ITEM and DESCRIPTION	CARDINAL PART NO.
HOMERUN CABLE, 5 CONDUCTORS, SHIELDED PVC (CONTAINS 2 x 18AWG, 2 x 22AWG, AND 1 x 22AWG)	6980-1092
BAGGED CONNECTOR AND INSTRUCTION SHEET (INCLUDES 5-PIN ACTUATION LEVER-TYPE CONNECTOR, 6610-1308)	3502-0681-0A

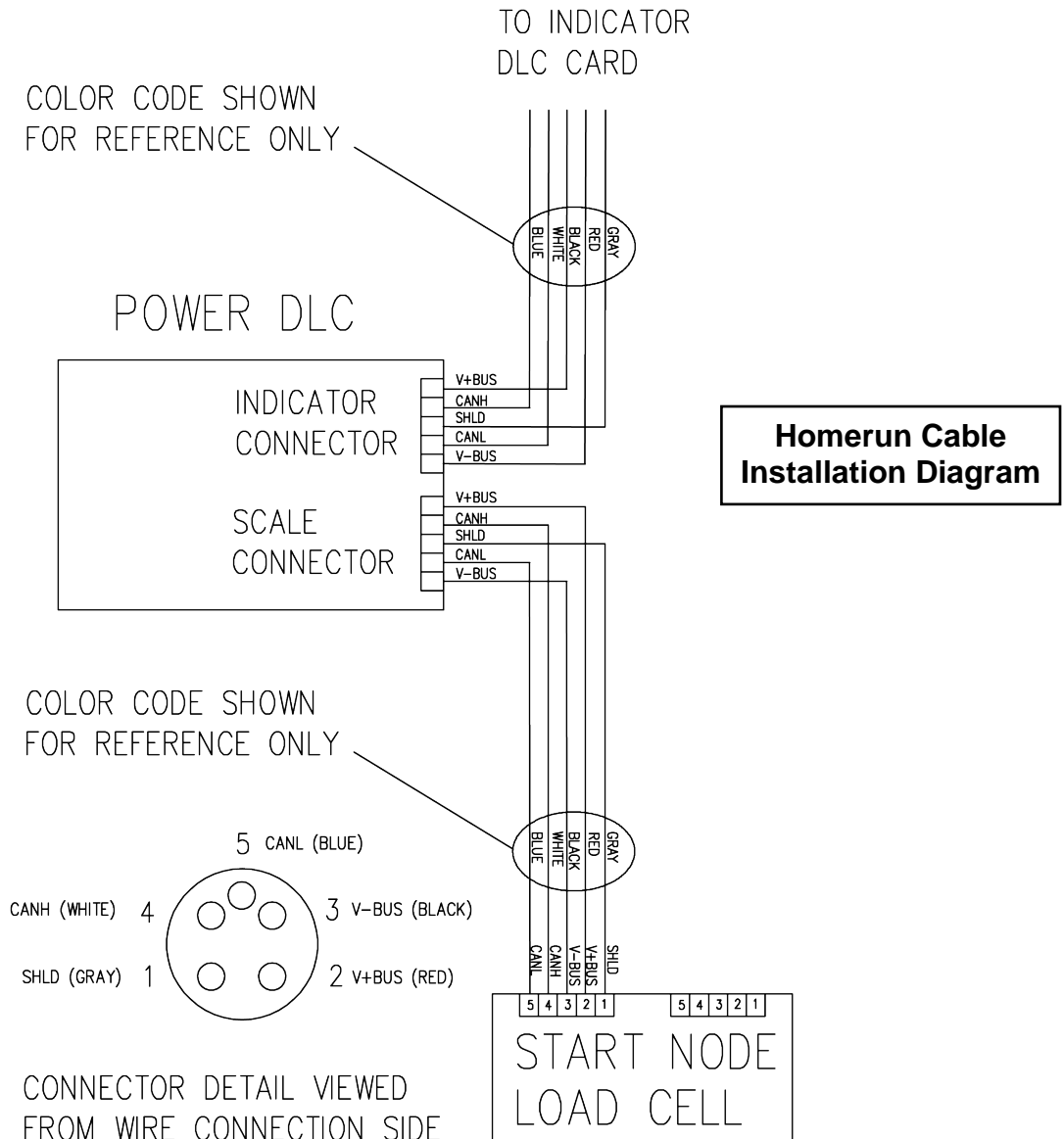

The main (longer) section of the Homerun cable is connected to the first load cell in the loop (the Start Node) and the SCALE terminal block in POWER-DLC. An additional (shorter) section of Homerun cable is then connected to the INDICATOR terminal block in the POWER-DLC and the indicator DLC card.

 **IMPORTANT! MAKE SURE THE ICAN JUMPERS, J2 AND J3 ON THE 225-DLC CARD (J1 AND J3 ON THE 825-DLC CARD) ARE REMOVED BEFORE APPLYING POWER!**

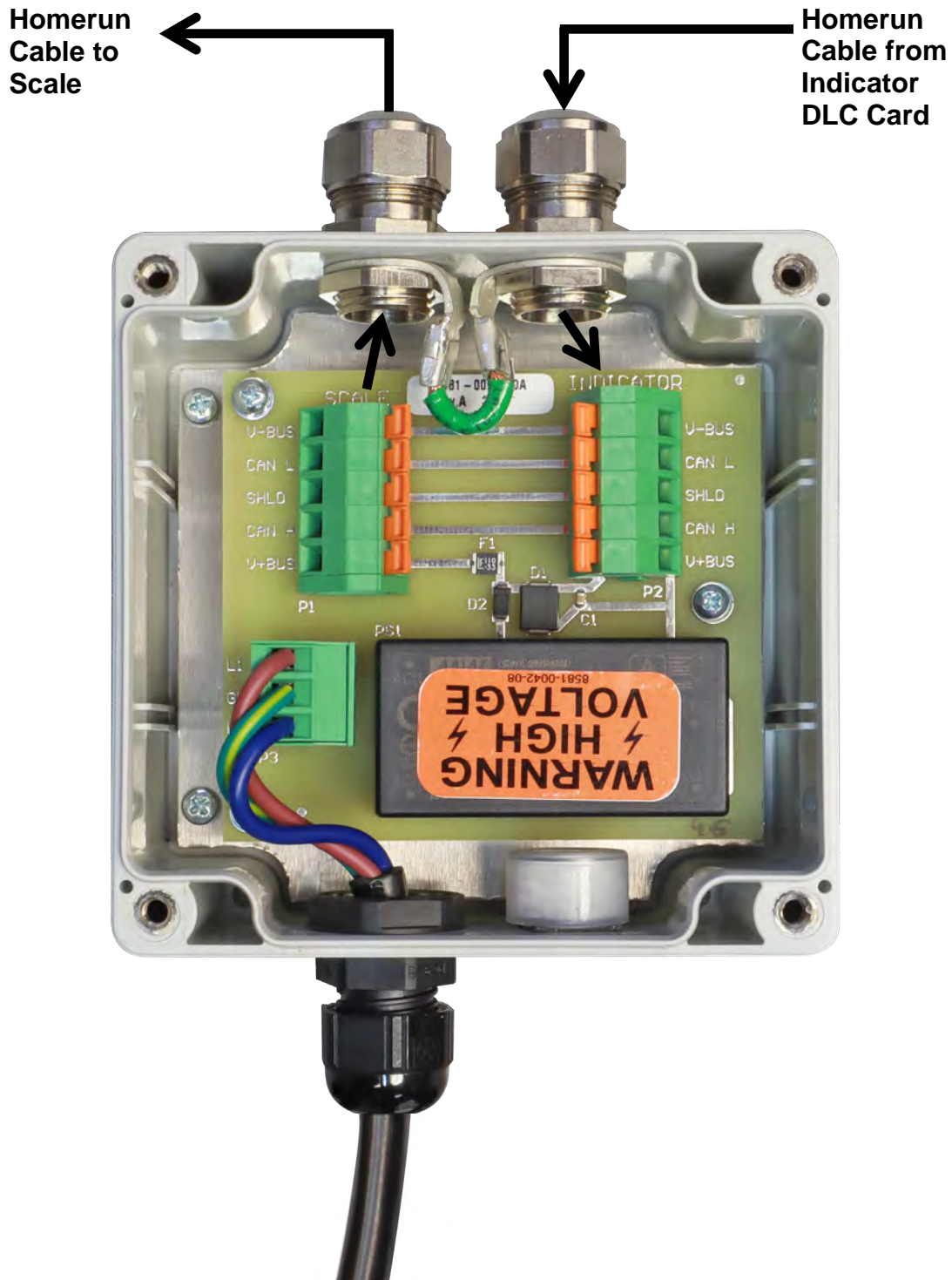

Power-DLC to Scale Connection

To suppress noise, the homerun cable to the scale should be routed through the special metallic gland connector in the POWER-DLC, and the cable shield from the homerun cable connected to the metal gland connector for grounding. Refer to the image on page 7 for the POWER-DLC gland connector layout.

1. Remove the four screws securing the cover of the POWER-DLC.
2. Loosen and remove the metal gland connector nut, then remove the plastic insert.
3. Slip the homerun cable to the scale through the nut and plastic insert.
4. Remove approximately 3.0 inches (76 mm) of the homerun cable outer jacket, exposing the cable shield and internal wires.
5. Cut the cable shield so it extends past the outer jacket approximately 3/4 inches (19 mm).
6. Next, remove approximately 1/4 inch (6 mm) of the insulation from each of the five wires.
7. Slide the plastic insert up the cable and fold the cable shield back over the plastic insert.
8. Insert the plastic insert (with the cable shield) into the metal gland connector for the scale. The cable shield will be secured when tightening the gland connector nut.
9. Make sure the gland connector nut is tight, but do not over-tighten it.
10. With the homerun cable to the scale routed into the POWER-DLC, refer to the table below (or the circuit board) for terminal connections and connect each wire to the SCALE terminal block on the POWER-DLC board.

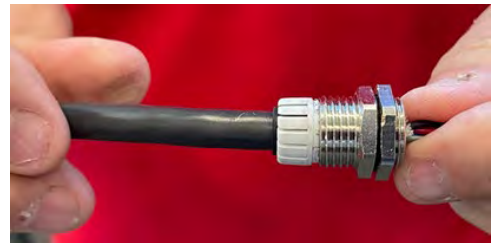

POWER-DLC SCALE Connector Terminal Connections

Board Label	Homerun Cable Wire Color	Wire Color if using a Load Cell Cable
SHLD	GRAY	BROWN
V+BUS	RED	WHITE
V-BUS	BLACK	BLUE
CAN H	WHITE	BLACK
CAN L	BLUE or LIGHT BLUE	GRAY

11. Using a small flat blade screwdriver press down on the release bar for the terminal, insert the wire into the opening, and then remove the screwdriver. The release bar will return to its original position, locking the wire in place.
12. Repeat steps 10 and 11 until all five wires of the homerun cable to the scale are installed in the SCALE terminal block on the POWER-DLC board.

Power-DLC to Indicator DLC Card Connection

To suppress noise, the homerun cable from the indicator DLC card should be routed through the special metallic gland connectors in the POWER-DLC and the cable shield from the cable connected to the metal gland connector for grounding. Refer to the image on page 7 for the POWER-DLC gland connector layout and the images on page 8 for installing the homerun cable shield in the gland connector.

1. With the cover, off from the previous operation, loosen and remove the metal gland connector nut, then remove the plastic insert.
2. Slip the homerun cable from the DLC card through the nut and plastic insert.
3. Remove approximately 3.0 inches (76 mm) of the homerun cable outer jacket, exposing the cable shield and internal wires.
4. Cut the cable shield so it extends past the outer jacket approximately 3/4 inches (19 mm).
5. Next, remove approximately 1/4 inch (6 mm) of the insulation from each of the five wires.
6. Slide the plastic insert up the cable and fold the cable shield back over the plastic insert.
7. Insert the plastic insert (with the cable shield) into the metal gland connector for the indicator. The cable shield will be secured when tightening the gland connector nut.
8. Make sure the gland connector nut is tight, but do not over-tighten it.
9. With the homerun cable from the DLC card routed into the POWER-DLC, refer to the table below (or the circuit board) for terminal connections, and connect each wire to the INDICATOR terminal block on the POWER-DLC board.

POWER-DLC TERMINAL Connector Terminal Connections

Board Label	Homerun Cable Wire Color	Wire Color if using a Load Cell Cable
SHLD	GRAY	BROWN
V+BUS	RED	WHITE
V-BUS	BLACK	BLUE
CAN H	WHITE	BLACK
CAN L	BLUE or LIGHT BLUE	GRAY

10. Using a small flat blade screwdriver press down on the release bar for the terminal, insert the wire into the opening, and then remove the screwdriver. The release bar will return to its original position, locking the wire in place.
11. Repeat steps 9 and 10 until all five wires of the homerun cable to the scale are installed in the SCALE terminal block on the POWER-DLC board.

Re-Installing the POWER-DLC Cover

1. After all connections to the SCALE and INDICATOR terminal blocks have been made, secure the POWER-DLC cover with the four screws removed earlier, following a diagonal pattern when tightening the screws.
2. Using a torque wrench, tighten the metal gland connectors to 33 in-lb (3.7 Nm).

POWER-DLC to 225D Indicator Connection

To suppress noise, the (shorter section) of the homerun cable from the INDICATOR terminal block in the POWER-DLC, should be routed through the metallic gland connector installed in the lower right of the 225D rear panel, and the cable shield from the cable connected to the metal gland connector for grounding. Refer to the image below for the gland connector layout and the images on page 8 for installing the homerun cable shield in the gland connector.

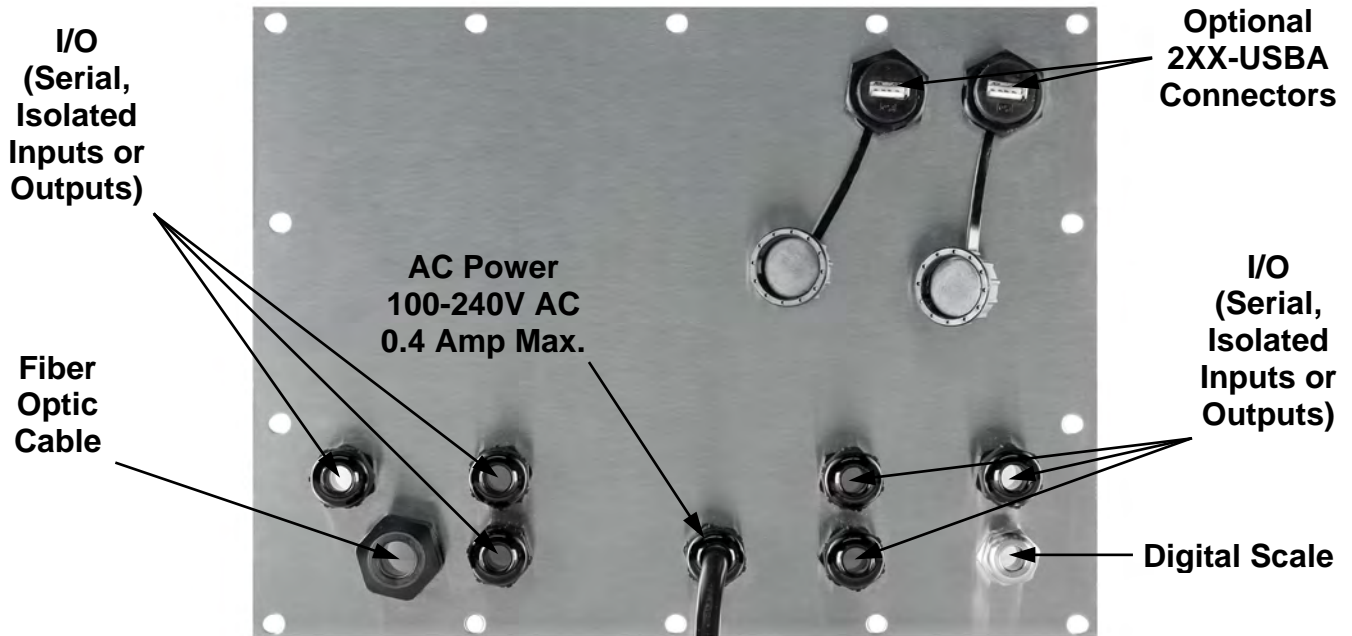



ATTENTION!
OBSERVE PRECAUTIONS FOR HANDLING
ELECTROSTATIC SENSITIVE DEVICES

1. Remove the fourteen acorn nuts securing the rear panel assembly to the main housing.
2. Lift the rear panel from the main housing, taking care not to stretch the cable and wires between the panel and main housing. Lay the panel on the workbench next to the indicator.

 **IMPORTANT:** You may need to loosen the gland connectors for the I/O cables to allow enough slack in the cable and wires to avoid stretching them.

3. Loosen and remove the metal gland connector nut, then remove the plastic insert.
4. Slip the homerun cable from the INDICATOR terminal block in the POWER-DLC through the nut and plastic insert.
5. Remove approximately 6.0 inches (15 cm) of the homerun cable outer jacket, exposing the cable shield and internal wires.
6. Cut the cable shield so it extends past the outer jacket approximately 3/4 inches (19 mm).

7. Next, remove approximately 1/4 inch (6 mm) of the insulation from each of the five wires.
8. Slide the plastic insert up the cable and fold the cable shield back over the plastic insert.
9. Insert the plastic insert (with the cable shield) into the metal gland connector on the 225D rear panel. The cable shield will be secured when tightening the gland connector nut.
10. Make sure the gland connector nut is tight, but do not over-tighten it.
11. Referring to the table below (or the circuit board) for terminal connections, connect each wire of the homerun cable from the POWER-DLC to the P5 terminal block on the 225DLC controller card.

225DLC Controller Card P5 Terminal Connections

Board Label	Homerun Cable Wire Color	Wire Color if using a Load Cell Cable
SHLD	GRAY	BROWN
V+BUS	RED	WHITE
V-BUS	BLACK	BLUE
CAN H	WHITE	BLACK
CAN L	BLUE or LIGHT BLUE	GRAY

12. Using a small flat blade screwdriver press down on the release bar for the terminal, insert the wire into the opening, and then remove the screwdriver. The release bar will return to its original position, locking the wire in place.

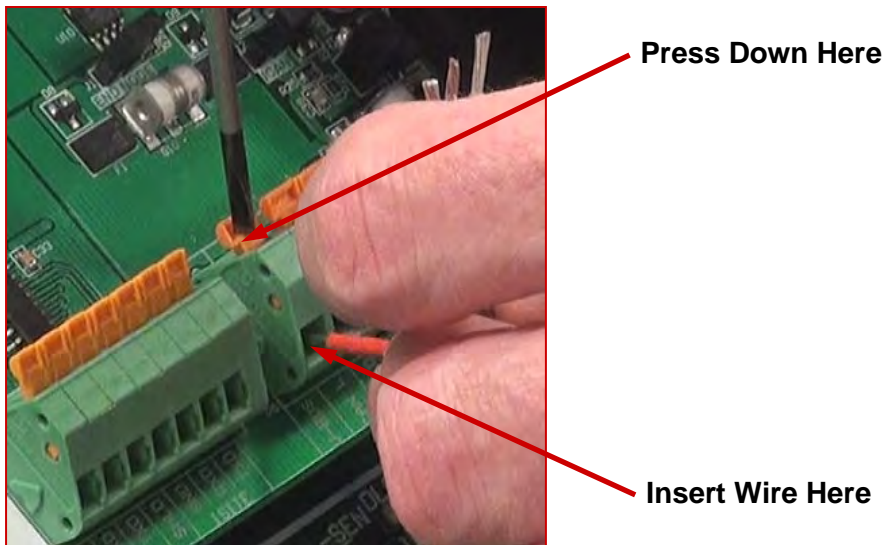

13. Repeat steps 11 and 12 until all five wires of the homerun cable are installed in the P5 terminal block on the 225DLC controller card.
14. Referring to the illustration on the next page, remove the ICAN jumpers J2 and J3.

225DLC Card ICAN Jumpers

The ICAN jumpers (J2 and J3) must be OFF (on one pin only or removed) when using the POWER-DLC to power the digital load cells in the scale. **NOTE:** If these jumpers are ON (installed), the 225D indicator is supplying the power to the digital load cells in the scale, and the POWER-DLC *cannot* be used.



IMPORTANT! Jumpers J2 and J3 must be OFF (on one pin only or removed) when the POWER-DLC is used to power the digital load cells in the scale.

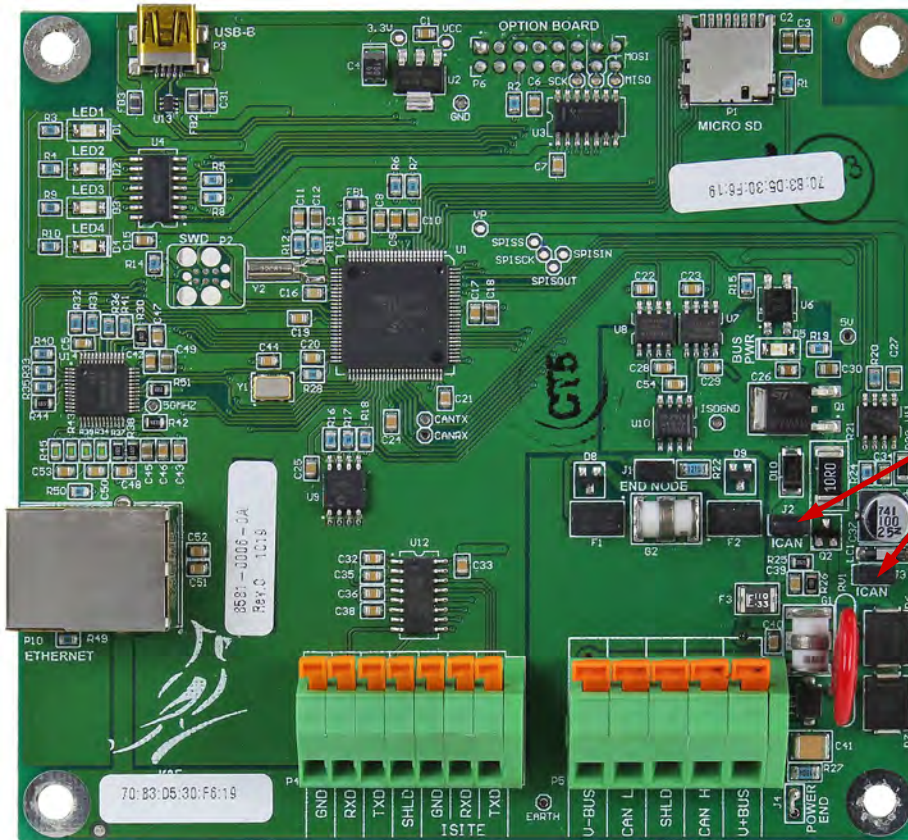

Remove J2, J3
ICAN Jumpers
when using
POWER-DLC

Re-installing the 225D Rear Panel

1. After all terminations have been made and the ICAN jumpers J2 and J3 have been removed, remove the excess cable from any other cables from the indicator enclosure, and finger-tighten each of the cable gland connectors.
2. Ensure any unused gland connectors are plugged and replace the rear panel.
3. Secure the rear panel with the fourteen acorn nuts removed earlier, following a diagonal pattern when tightening the acorn nuts.
4. Using a torque wrench, tighten the plastic gland connectors to 15 in-lb (1.7 Nm).
5. Using a torque wrench, tighten the metal gland connector to 33 in-lb (3.7 Nm).

POWER-DLC to 825D Indicator Connection

To suppress noise, the (shorter section) of the homerun cable from the INDICATOR terminal block in the POWER-DLC, should be routed through the metallic gland connector installed in the bottom panel of the 825D, and the cable shield from the cable connected to the metal gland connector for grounding. Refer to the image below for the gland connector layout and the images on page 8 for installing the homerun cable shield in the gland connector.

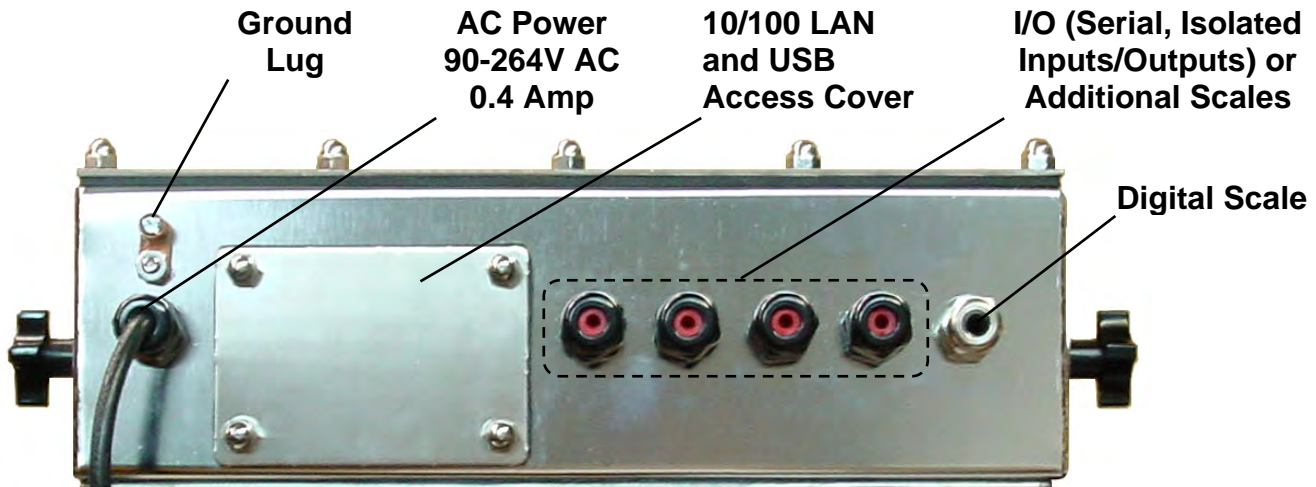

1. Remove the fourteen acorn nuts securing the rear panel assembly to the main housing.
2. Lift the rear panel from the main housing, taking care not to stretch the cable and wires between the panel and main housing. Lay the rear panel on the workbench next to the indicator.

 **IMPORTANT:** You may need to loosen the gland connectors for the I/O cables to allow enough slack in the cable and wires to avoid stretching them.

3. Loosen and remove the metal gland connector nut, then remove the plastic insert.
4. Slip the homerun cable from the INDICATOR terminal block in the POWER-DLC through the nut and plastic insert.
5. Remove approximately 6.0 inches (15 cm) of the homerun cable outer jacket, exposing the cable shield and internal wires.
6. Cut the cable shield so it extends past the outer jacket approximately 3/4 inches (19 mm).
7. Next, remove approximately 1/4 inch (6 mm) of the insulation from each of the five wires.

8. Slide the plastic insert up the cable and fold the cable shield back over the plastic insert.
9. Insert the plastic insert (with the cable shield) into the metal gland connector on the bottom of the 825D. The cable shield will be secured when tightening the gland connector nut.
10. Make sure the gland connector nut is tight, but do not over-tighten it.
11. Remove the screw securing the 825-DLC card to the 825D main PC board and then lift the 825-DLC card straight up to remove it from the enclosure
12. Referring to the table below (or the circuit board) for terminal connections, connect each wire of the homerun cable from the POWER-DLC to the P1 terminal block on the 825-DLC controller card.

825DLC Controller Card P1 Terminal Connections

Board Label	Homerun Cable Wire Color	Wire Color if using a Load Cell Cable
SHLD	GRAY	BROWN
V+BUS	RED	WHITE
V-BUS	BLACK	BLUE
CAN H	WHITE	BLACK
CAN L	BLUE or LIGHT BLUE	GRAY

13. Using a small flat blade screwdriver press down on the release bar for the terminal, insert the wire into the opening, and then remove the screwdriver. The release bar will return to its original position, locking the wire in place.
14. Repeat steps 12 and 13 until all five wires of the homerun cable are installed in the P1 terminal block on the 825DLC controller card.
15. Referring to the illustration on the next page, remove the ICAN jumpers J1 and J3.
16. After all terminations have been made and the ICAN jumpers J1 and J3 have been removed, reinstall the 825-DLC into the enclosure, taking care not to strike the board against the side of the 825D enclosure.
17. Secure the 825-DLC to the main PC board with the screw removed earlier.

825-DLC Card ICAN Jumpers

The ICAN jumpers (J1, J3) must be OFF (on one pin only or removed) when using the POWER-DLC to power the digital load cells in the scale. **NOTE:** If these jumpers are ON (installed), the 825D indicator is supplying the power to the digital load cells in the scale, and the POWER-DLC *cannot* be used.



IMPORTANT! Jumpers J1 and J3 must be OFF (on one pin only or removed) when the POWER-DLC is used to power the digital load cells in the scale.

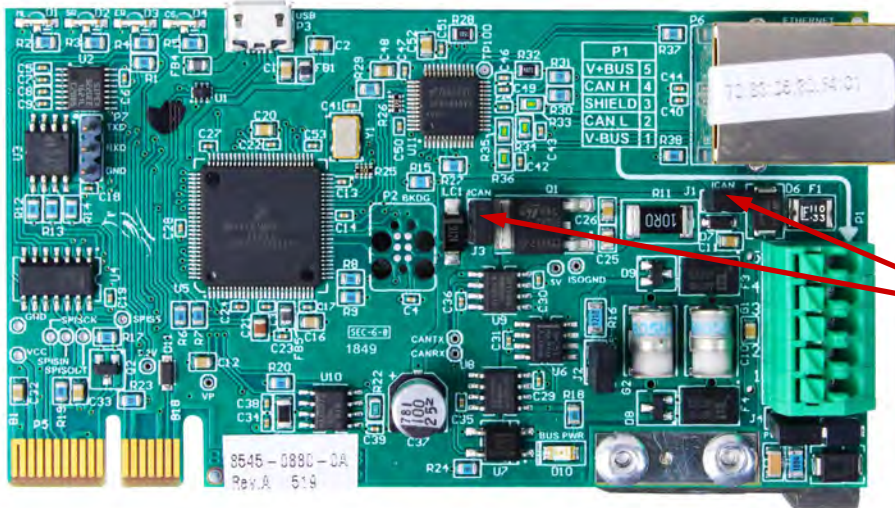

**Remove J1, J3
ICAN Jumpers
when using
POWER-DLC**

Re-installing the 825D Rear Panel

1. After all terminations have been made, and the 825-DLC is secured to the main PC board, remove the excess cable from any other cables from the indicator enclosure, and finger-tighten each of the cable gland connectors.
2. Ensure any unused gland connectors are plugged and replace the rear panel.
3. Secure the rear panel with the fourteen acorn nuts removed earlier, following a diagonal pattern when tightening the acorn nuts.
4. Using a torque wrench, tighten the plastic gland connectors to 15 in-lb (1.7 Nm).
5. Using a torque wrench, tighten the metal gland connector to 33 in-lb (3.7 Nm).

Load Cell to POWER-DLC Connection

The main (longer section) of the Homerun Cable is installed between the first load cell in the loop (Start Node) and the SCALE terminal block of the POWER-DLC. It is made from five conductors, shielded PVC cable, and terminated with the *included* 5-pin actuation lever-type connector from the Homerun Cable Connector Pack. Refer to the table below for cable and connector information.

Cable and Connector Information

ITEM and DESCRIPTION	CARDINAL PART NO.
HOMERUN CABLE, 5 CONDUCTORS, SHIELDED PVC (CONTAINS 2 x 18AWG, 2 x 22AWG, AND 1 x 22AWG)	6980-1092
BAGGED CONNECTOR AND INSTRUCTION SHEET (INCLUDES 5-PIN ACTUATION LEVER-TYPE CONNECTOR, 6610-1308)	3502-0681-0A



IMPORTANT: Clean the load cell connectors and the homerun connector plug with electrical contact cleaner, and then apply dielectric grease to the homerun connector plug before installing it into the load cell connector.

1. Dis-assemble the connector (unscrew the black plastic part of the connector from the metal part), and then slide the black plastic part onto the homerun cable.

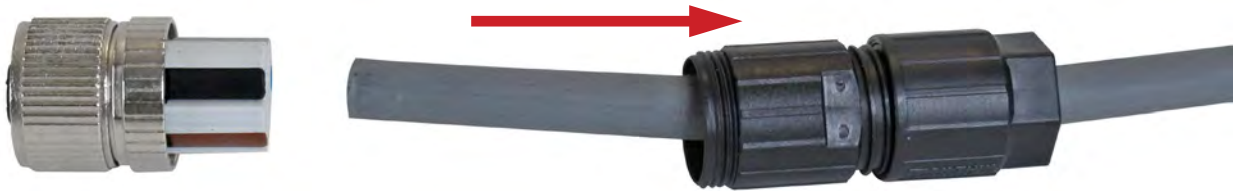

2. With the homerun cable routed through the black plastic part of the connector, remove approximately 1 inch (25 mm) of the cable's outer jacket, exposing the internal wires.
3. Next, remove approximately 5/16 inches (8 mm) of insulation from each of the five wires.



NOTE: The hex part of the black plastic cable clamp is approximately 5/16 inches (8 mm) and can be used as a guide for stripping the wires.

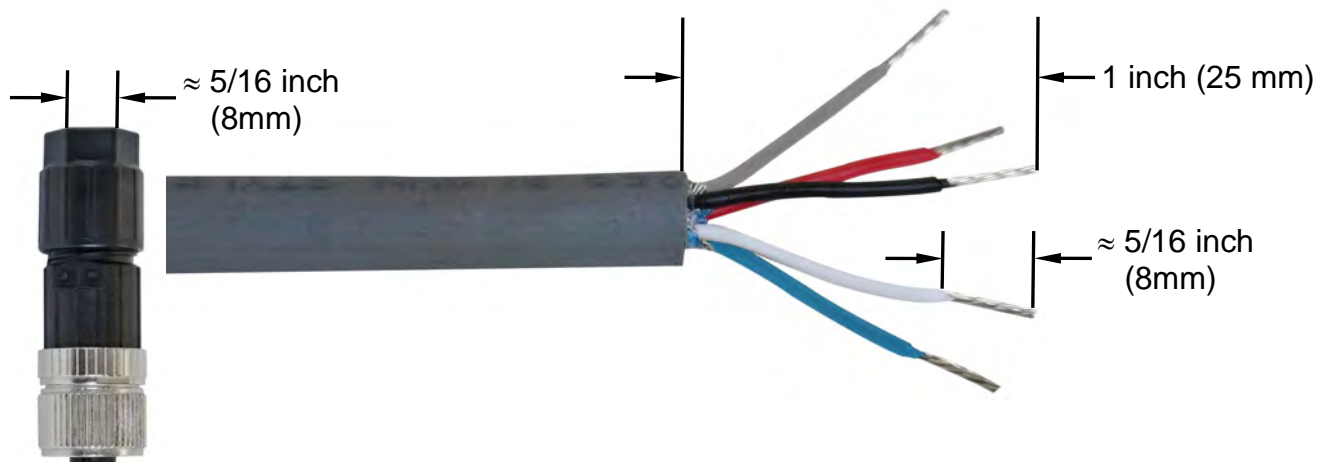



Refer to the Homerun Connector Wiring Color Code Table below when performing steps 4 through 7.

Homerun Connector Wiring Color Code Table

Connector Pin Number	Connector Lever Color	Signal	Homerun Cable Wire Color	Wire Color if using a Load Cell Cable
1	BROWN	SHLD	GRAY	BROWN
2	WHITE	V+BUS	RED	WHITE
3	BLUE	V-BUS	BLACK	BLUE
4	BLACK	CAN H	WHITE	BLACK
5	GRAY	CAN L	BLUE or LIGHT BLUE	GRAY

- Looking at the end of the metal part of the connector where the wires are inserted, use your fingernail, and gently pull a wire clamp lever down away from the body of the connector.
- Insert the wire into the appropriate connector opening, and then close the wire clamp lever.
- Verify that the wire is being held securely in the connector by lightly pulling on the wire.

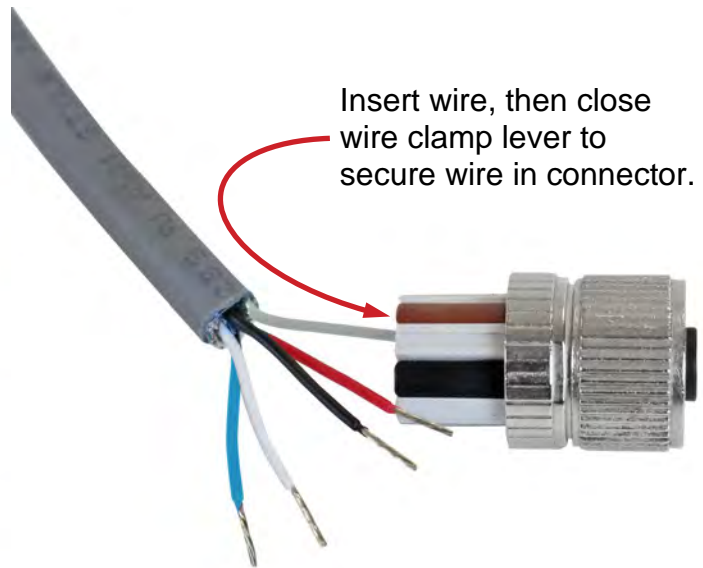
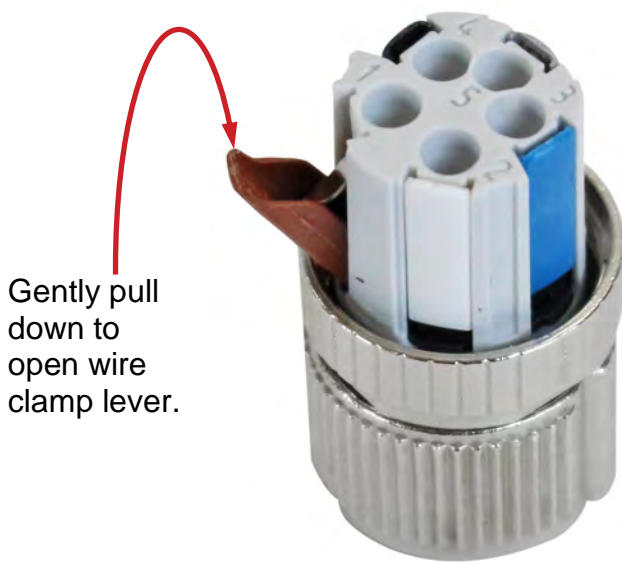

- Repeat steps 4 through 6 until all five wires of the homerun cable are installed in the metal part of the connector.

8. After all connections have been made, slide the black plastic and metal connector parts together, and then screw them together by hand-tightening.



9. To complete the assembly, hold the black and metal parts of the connector housing, and then hand-tighten the cable clamp to the black plastic part of the connector housing.

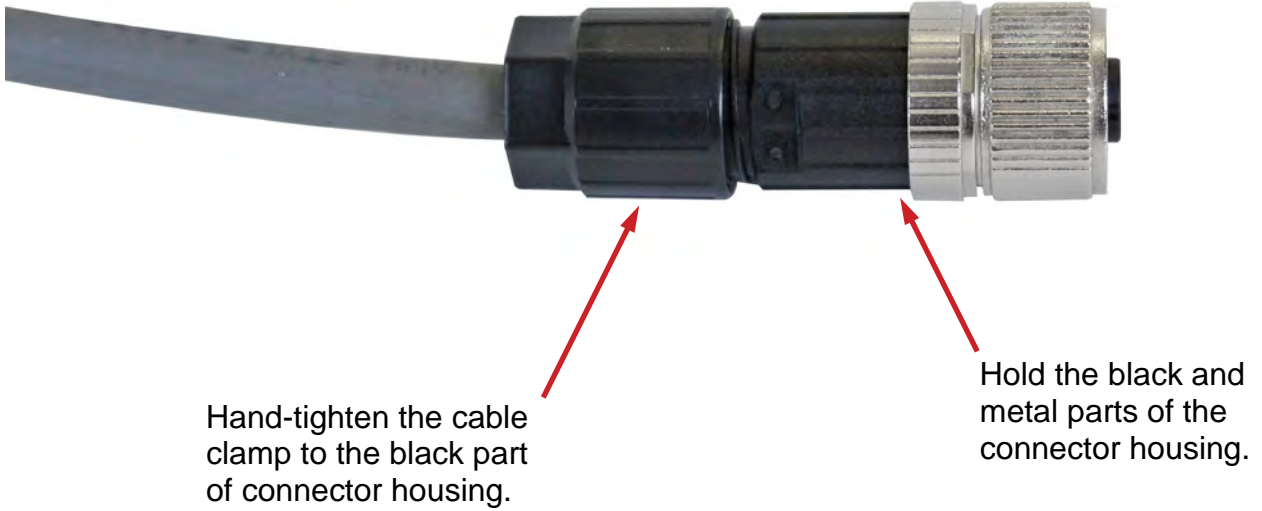

NOTE: For reference, the image below, shows the cable clamp separated from the connector housing in order to view the cable clamp collar.



GROUNDING INSTRUCTIONS

Grounding Specifications – 3502-0671-GS

1. The ground rod shall be copper plated 0.5 in. (1.27 cm.) minimum diameter, with clean exterior surfaces, and shall not be covered with paint, enamel, or other materials, which are poor conductors.
2. The ground rod shall be embedded below permanent moisture level at least 8 ft. (2.44 m.) where practicable. Where rock bottom is encountered, at depth of less than 4 ft. (1.22 m.), the ground rod shall be buried in a horizontal trench.
3. Connect the weighbridge to the ground rod with a minimum 1.5" (38.1 mm) flat braided cable or ground wire. Clamp the flat braided cable (or ground wire) to the 1.5" x .5" (38.1 mm x 12.7 mm) round stud on the section 2 weighbridge. After installation of the flat braided cable (or ground wire), check for continuity between the conductive scale components and the ground rod.
4. Connect the scale grounding stud to the grounding lug on the indicator, using the supplied 10 GA-(6.0 sq. mm) stranded insulated wire.

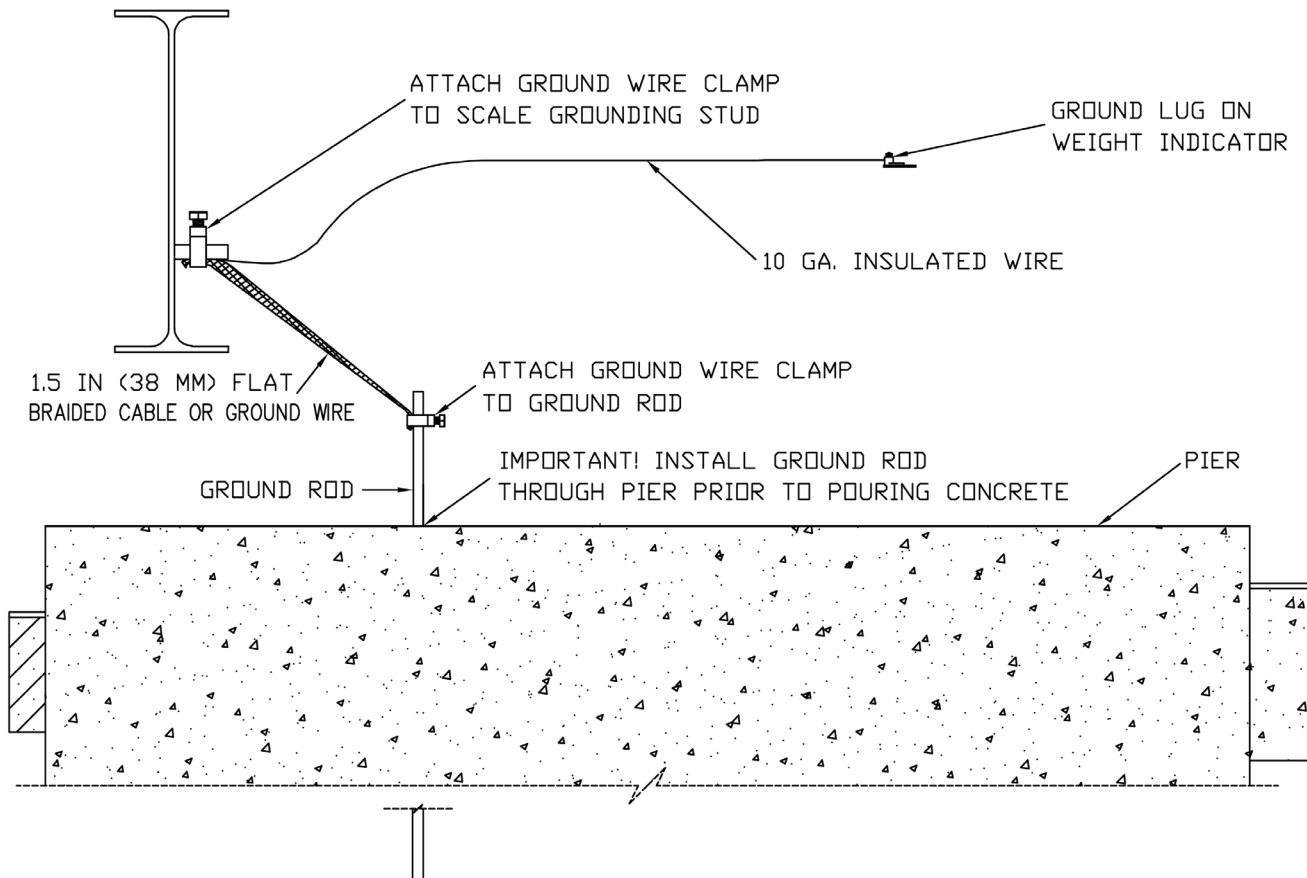
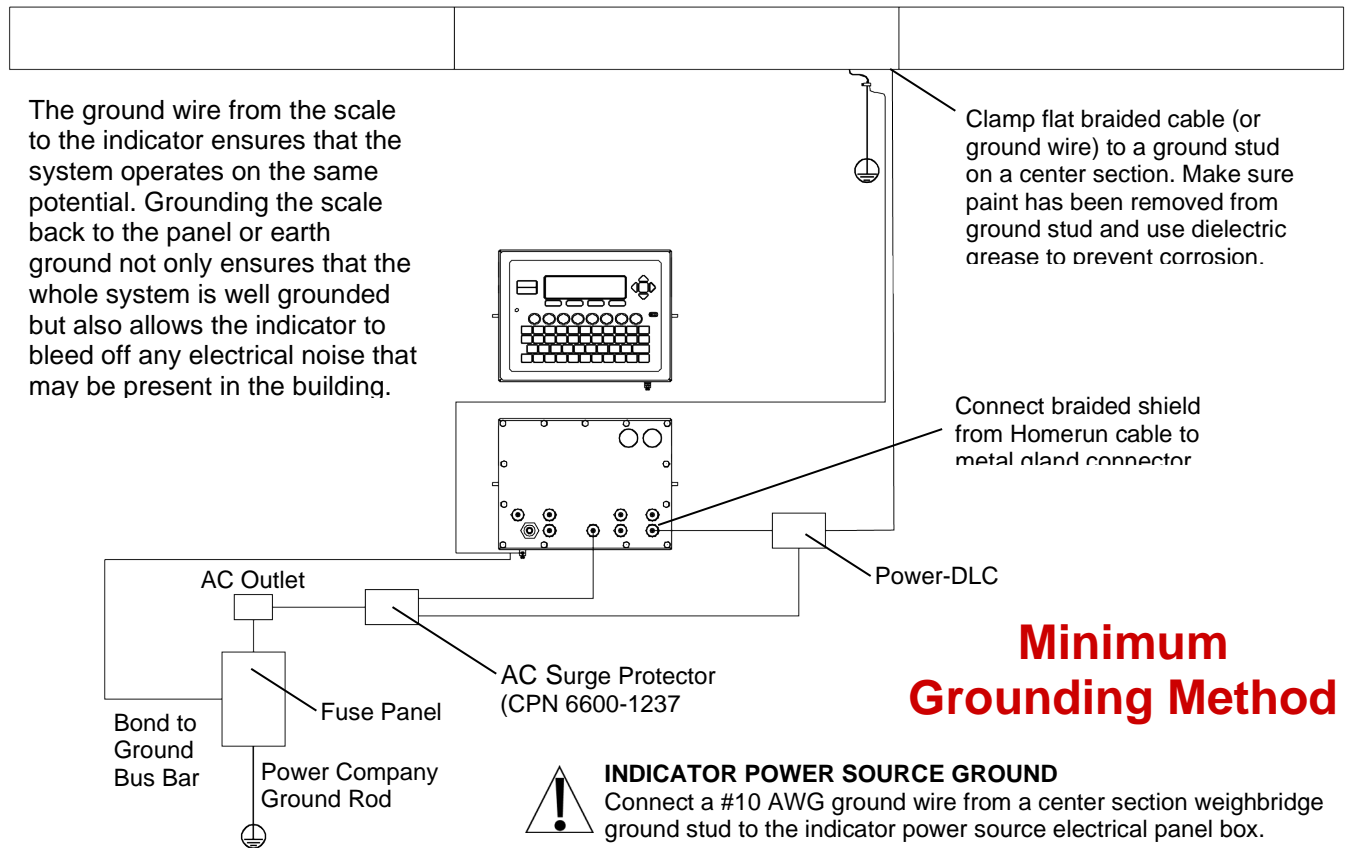
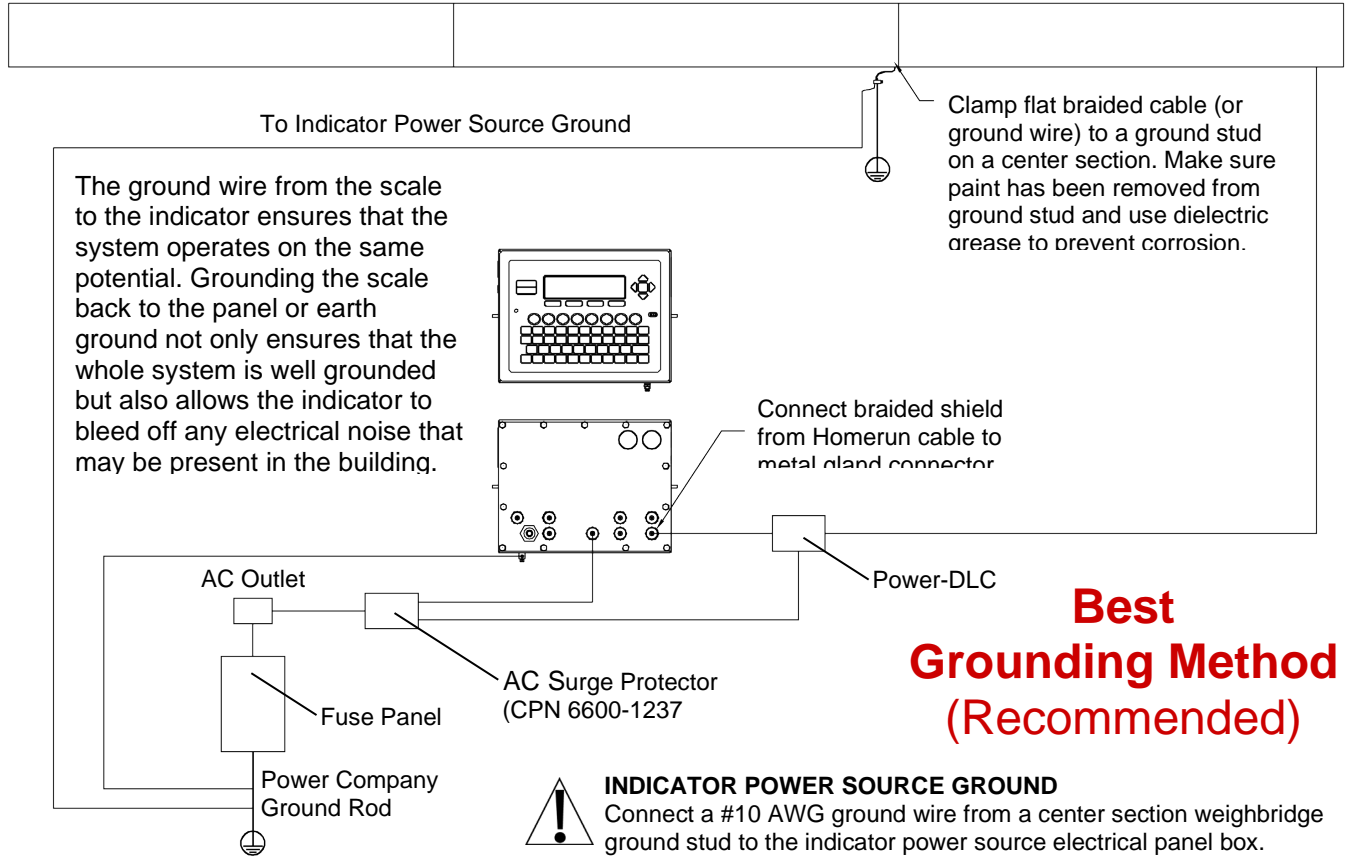

**Diagram of Scale and Indicator Grounding per 3520-0671-GS
(New Scale Installation Shown)**



IMPORTANT! The ground rod should be driven in the ground (through the area for the pier) prior to pouring the concrete. Leave approximately 6 inches of the ground rod exposed above the pier.

SCBD Load Cell Scale Grounding Specifications – 3502-0713-GS



Grounding Instructions for SCBD Load Cell Scales

Cardinal Scale Mfg. Co. recommends the following grounding procedures for new and existing installations of scales using SCBD load cells. This grounding scheme is valid for various soil types and should help minimize downtime and repair costs caused by lightning damage.

SUPPLIED GROUNDING COMPONENTS

Description	Qty.	Part No.
Ground Rod .625" Diameter X 10 Feet.	1	6980-0054
Ground Cable, 1 1/2" Flat Braid #3 AWG	1	6980-0036
Wire #10 AWG Stranded, Green	1	6980-0035
Grounding Clamp	2	6610-5023
Dielectric Grease (<i>included in Homerun Connector bag kit</i>)	1	6050-3056

Site Requirements

1. Make sure the AC outlet the indicator is plugged into is wired correctly. An AC outlet circuit tester can be used to check for proper Line, Neutral, and Earth ground wiring.
2. It is recommended that metal conduits be used with separate conduit runs for the AC power lines and the data lines.
3. To prevent electrical induction into the data lines during a lightning strike, the scale ground wire should be routed in a separate conduit away from the data lines.
4. A surge protector (CPN 6600-1237) is **required** between the AC power source and the indicator.
5. On an existing scale site, the ground rod should be driven into the ground with approximately 6 inches of the ground rod exposed.

NOTE: For a new installation, the ground rod should be driven in the ground (through the area for the pier) prior to pouring the concrete. Leave approximately 6 inches of the ground rod exposed above the pier.

Indicator and Scale Lightning Protection Connections

Follow these steps to ensure the indicator ground and the scale ground are at the same potential which is necessary for good lightning protection:

1. Make sure the flat braided cable (or ground wire) and grounding clamp are connected to a ground stud on a center section of the scale. Make sure the paint has been removed from the ground stud and use a dielectric grease (CPN # 6050-3056) to prevent corrosion.
2. Connect the other end of the flat braided wire (or ground wire) near the top of the ground rod so the clamps won't corrode due to ground moisture. Make sure the flat braided wire (or ground wire) has at least a *1-foot loop* to ensure the weight operation is not affected.

3. Connect a #10 AWG or larger copper ground wire from the ground rod clamp to the indicator power source ground (the indicator power source ground is the electrical panel box that provides power to the indicator).



NOTE: If connecting to the electrical panel box is impractical, connect the #10 AWG wire to the indicator power outlet ground.

4. Connect a # 10 AWG ground wire from the indicator's copper ground lug, at the bottom of the 225D enclosure (or back of the 825D enclosure), to the indicator power source ground. *Connect the indicator ground wire at the same point as the scale ground wire.*
5. The scale must be inspected periodically to ensure that all connections are tight and that there is no corrosion to the braided cable (or ground wires) or wire clamps. Use an "Earth Ground Resistance Tester" to measure the ground connection. A connection that measures higher than 1 ohm of resistance should be cleaned or replaced.

Scale Ground Stud to Ground Rod Connections

1. Clamp the flat braid cable (or ground wire) to a ground stud on a center section of the scale. Make sure the paint has been removed from the ground stud and apply dielectric grease to prevent corrosion.
2. Clamp the other end of the flat braided cable (or ground wire) to the ground rod to connect the scale ground stud to the ground rod. Connect the flat braided cable (or ground wire) near the top of the ground rod so the clamp will not corrode due to ground moisture.
NOTE: Make sure the flat braided cable (or ground wire) has at least a *1 ft (31 cm) loop* to ensure the weight operation is not affected.
3. After the installation of the flat braided cable (or ground wire) has been completed, check for continuity between the conductive scale components (weighbridge) and the ground rod.

SCALE SETUP AND CONFIGURATION

Digital Scale Setup and Configuration

All digital scales using Cardinal Scale's SCBD SmartCell® digital load cells are connected with a daisy-chained CAN (Controller Area Network) cable. The load cell connection loop can begin at any load cell and may continue clockwise as shown or counter-clockwise if preferred.

For example, in the illustration below, the connection loop begins with load cell 4 and runs clockwise ending with the end node terminator on load cell 6. Also, note that there is no connection between load cell 4 and load cell 6.



IMPORTANT! Be sure to insert the end node termination plug on the load cell at end of the loop as shown in the example.

Example: Typical Truck Scale Configuration

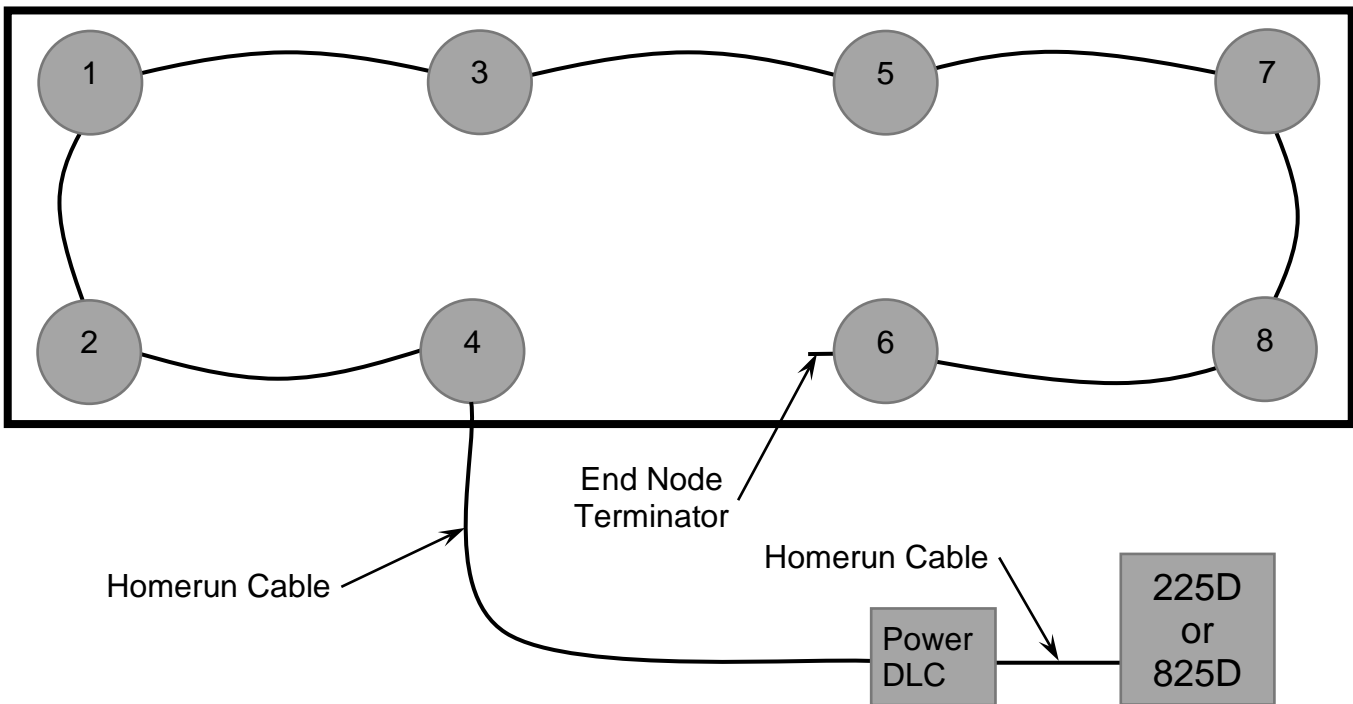

NOTE: If the loop were run in the other direction, the sequence would then be 6-8-7-5-3-1-2-4 with load cell 4 having the End Node Terminator installed on it.

To Begin 225D Setup and Configuration

Addressing Cells

Each cell has a serial number (S/N) marked on the cell. This is an 8-digit hexadecimal number. It is also known as the cell ID. Each Cell ID must be matched with a cell address. In the example on the previous page, the addresses would be 1-8.

1. Enter the SETUP menu by pressing **SHIFT+RED_KEY**.
2. Press **ENTER** again to get to SETUP MENU #1.
3. Press **8** and **ENTER** to set the number of scales and cells.

```

SETUP MENU #1
1. USA=XXX          6. CLR TARE=XXX
2. NSC=XXX          7. CLEAR ID=XXX
3. LFT=XXX          8. SCALES=X CELLS=X
4. OIML=N/A         9. TOTALIZE=XXX
5. TIME=XX          10. MODE OF OP=1   IDS
Enter Selections:  0  [ ]NEXT [ ]EXIT
  
```

4. Enter the number of scales and press **ENTER**.
5. Enter the number of cells and press **ENTER**. The addressing menu will appear.

```

CELL TO SCALE ASSIGNMENTS
1. CELL 1  SCALE=1  ID=1D7A173F  START
2. CELL 2  SCALE=1  ID=0EB0EBFF  END
3. CELL 3  SCALE=1  ID=18B8783F
4. CELL 4  SCALE=1  ID=09C99FFF

Enter Selections:  0  [ ]NEXT [ ]EXIT
                   END NODES  EXIT
  
```

6. Press a cell number, and then **ENTER** to be prompted for the associated scale number followed by the cell ID.
7. If the cell is found, the indicator will display "CELL RESPONDED". If the cell does not respond the 225D will sound an error beep and display "—FAILED—". If the cell is disconnected, then this error can be ignored.

End Nodes

The 225D also needs to know where the scale starts and ends. The START NODE is the cell that is connected to the 225D. The END node is the last cell in the daisy chain. In the example on the previous page, the START node is #4 and the END node is #6.

To set the nodes:

1. Press the **END NODES** soft key.
2. The 225D will display "WHICH CELL CONNECTS TO THE 225? "
3. In the previous example, the user would enter **4** and **ENTER**.
4. The 225D will display "WHICH CELL IS THE LAST IN THE LOOP? "
5. In the previous example, the user would enter **6** and **ENTER**.

225D Calibration

If, after test loading the scale, it is determined that adjustments are required, follow the procedure below. This section describes the procedure necessary to calibrate a Cardinal Digital Truck Scale.

1. Before any adjustments are made, turn on the power to the digital weight indicator.
2. Drive a test truck across the scale *at least three times* in each direction before calibrating the scale.
3. Before any sealing can be done, the weight indicator must be calibrated to the scale. A division size of 10 lbs should be selected and the auto-zero function turned off. Refer to the 225 Weight Indicator Installation and Technical Manual.

All digital cells are pre-calibrated for span in the factory. That means that span calibration is not necessary to start making weights. Only a zero calibration is necessary. However, a Smart Calibration is still usually necessary to trim the corners and sections of a scale.

Navigating to the DLC Calibration Menu

1. Enter SETUP by pressing **SHIFT+RED_KEY**.
2. Press **ENTER**.
3. Press **DOWN** to get to SETUP MENU #2.
4. Select **SETUP SCALE #X** where 'X' is the scale number.
5. Press **DOWN** to get to SCALE X SETUP MENU #2.
6. Enter **10** and press **ENTER** to open the DLC calibration menu.

```
SCALE 1 CALIBRATION MENU
1. SMART CALIBRATION
2. ZERO CALIBRATION
3. TRIM CELL(S)
4. SPAN ADJUST

Enter Selection: @

EXIT
```



IMPORTANT! Before calibrating the scale, the dead load of the weighbridge must be evenly distributed between the pair of cells in a section. Refer to the Balancing Weighbridge Dead Load section on page 56 of this manual for more instructions.

SMART CALIBRATION

Smart Calibration is not necessary to make weight, but it is helpful for trimming all load cells automatically.

1. Press **1** and **ENTER**. The 225D will prompt for “CAL WT = 0”.
2. Enter the weight of the test weight.
3. The 225D will display...
VERIFY SCALE IS EMPTY
PRESS ENTER TO CONTINUE
4. With an empty scale, press **ENTER**. This will capture the calibrated dead load weight of the scale.
5. The 225D will display...
PLACE WEIGHT ON CELL X
PRESS ENTER TO CONTINUE
6. Center the weight over scale X and press **ENTER** to take a weight sample.
7. Repeat steps 5, and 6 for each cell in the order that the 225D prompts for. (This is the same order as other Cardinal scales, for example, 1, 3, 5, 7, 8, 6, 4, 2).

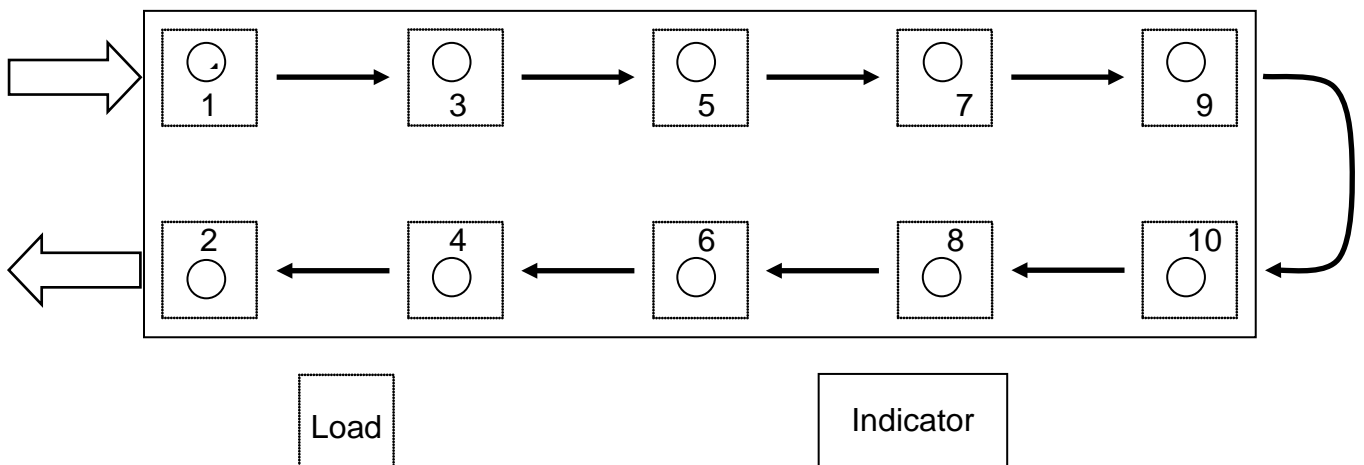

ZERO CALIBRATION

Zero Calibration does not affect the trimming of the cells or affect span. It simply sets the dead load weight of the scale.

1. Press **2** and **ENTER**.
2. The 225D will display...
VERIFY SCALE IS EMPTY
PRESS ENTER TO CONTINUE
3. Ensure the scale is empty and press **ENTER**. The scale will record dead load weight.

TRIM CELLS

Individual cells or pairs of cells may be trimmed. This requires a test load weight.

1. Press **3** and **ENTER**.
2. The 225D will prompt for "Cell Number(s):".
3. To trim a single cell, enter the cell number, and press **ENTER**. To trim a pair of cells, enter both cells in the form "X + Y", and press **ENTER**.
For example, to trim the pair of cells 5 and 6 enter "**5+6**" and press **ENTER**.
4. For information only, the 225D will display the cell trim "CELL # TRIM X.XXXXXXX". It will also display the total "SCALE WT = XXXXXX".
NOTE: High-resolution weight (interval/10) will be shown if the weight interval setting is less than 10. For example, an interval of 5 will be shown in 0.5 increments.
5. Place a test weight over the cell(s) to be adjusted.
6. Press the **SET_WT** soft key.
7. The 225D will prompt "ENTER NEW WEIGHT =".
8. Enter the actual correct weight of the test weight and press **ENTER**.
9. The 225D will automatically trim the cell to match the entered test weight.
10. Press the **PREVIOUS** and **NEXT** soft keys to navigate to other cells without exiting the trim menu.

SPAN ADJUST

Span adjust allows the user to tweak the span of the entire scale at once.

1. Press **4** and **ENTER**.
2. The 225D will display the current live scale weight "SCALE WT = XXXXX.X".
NOTE: High-resolution weight (interval/10) will be shown if the weight interval setting is less than 10. For example, an interval of 5 will be shown in 0.5 increments.
3. Note that high-resolution weight (interval/10) will be shown if the weight interval setting is less than 10. For example, an interval of 5 will be shown in 0.5 increments.
4. Place the test weight at any location on the scale.
5. Press **SET_WT** soft key. The 225D will prompt "ENTER NEW WEIGHT =".
6. Enter the value of the test weight and press **ENTER**.
7. The 225D will adjust the span to the target weight.

To Begin 825D Setup and Configuration

1. Press the **ON/OFF** key to turn on the 825D. The display will perform a short self-test and then change to the Startup screen showing the software versions and status of the mainboard and option cards.

```
CARDINAL 825
Item          Version  01 cards  I[#####]
MnBd DLC      1.21.011 Slot Type  Version
Loader        1.10.013  1   DLC    1.00.001
OS/Std Apps   1.12.021

1. Application program
2. Standard indicator
3. Legal metrology information / Setup
4. Digital Scale Diagnostics

MAC Address: 70:B3:D5:48:85:84
```



IMPORTANT! The **MnBd DLC** shown under **Item** indicates the mainboard is loaded with the DLC version of the software. The **Slot Type** is showing that Slot 1 of the 825D is occupied by a DLC card version “1.00.001”.

NOTE: Currently, the 825D only supports a single DLC card operation.

2. To configure the DLC operation use the navigation keys to select (highlight) the **3. Legal metrology information / Setup** option and then press the **ENTER** key.
3. Press the navigation keys to select (highlight) the **3.Setup menu** option, and then press the **ENTER** key.
4. The display will change to show the login and password prompt screen.

Login

1. With the **Login** screen and prompt displayed, use the alphanumeric keys to enter the login, and then press the ▾ Down Arrow to advance to the password prompt
2. Enter the password using the alphanumeric keys, and then press the **ENTER** key to proceed with Setup and Configuration.



NOTE: The 825D will arrive from the factory with the calibration access locked by the “login” and “password” prompts protection. The factory default login and password are “ADMIN” and “81440”.

3. The display will change to show the **Setup Menu** screen.

Setup Menu

Press :

1. Date/Time

2. Communication

3. Calibration

4. Update software menu

5. Preferences

6. Diagnostics

7. Operators

MAC Address: 70:B3:D5:48:85:84

3. Calibration

With the Setup Menu displayed, press the **3** key, or use the Navigation Keys to select (highlight) **3. Calibration**, and then press the **ENTER** key. The display will change to show the **Setup Scale Number** screen.

Setup Scale Number

Setup Scale Number

With the Setup Scale Number screen displayed, press the **D** key, or use the Navigation Keys to select (highlight) **D. Configure DLC**, and then press the **ENTER** key. The display will change to show the **Setup DLC Card 1** screen.

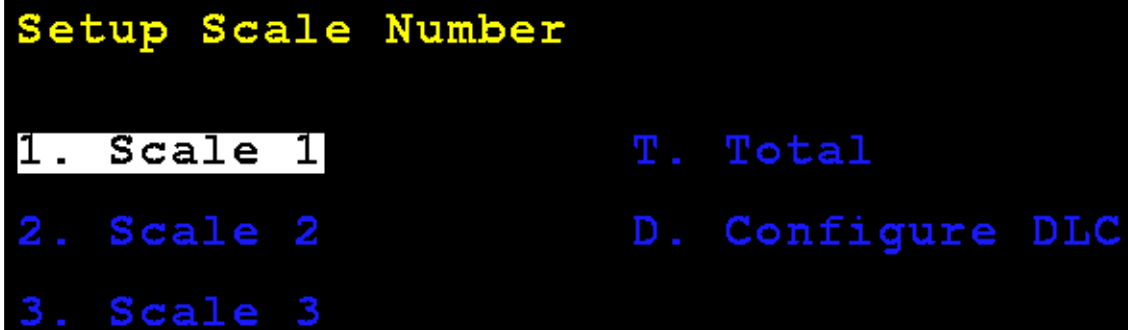

The screenshot shows a terminal-style menu with a black background and yellow and blue text. The title 'Setup Scale Number' is at the top in yellow. Below it, there are two columns of options. The first column has three items: '1. Scale 1' (highlighted with a white background), '2. Scale 2', and '3. Scale 3'. The second column has two items: 'T. Total' and 'D. Configure DLC'.

```
Setup Scale Number

1. Scale 1          T. Total
2. Scale 2          D. Configure DLC
3. Scale 3
```

Setup DLC Card 1

```
Setup DLC Card 1

Scales:      3  iSITE SO:123456
Cells:       12 DHCP:      No
First Cell:  1  IP:        10.1.3.109
Last Cell:   2  Netmask:  255.255.0.0
                Gateway:  10.1.1.1
```

Scales: – Set the number of scales.

Cells: – Set the total number of cells.

First Cell: – Set the cell number that is connected to the 825D indicator.

Last Cell: – Set the cell number of the end of the chain of load cells.

iSITE SO: – Set Sales Order or other identifiers for communications link to iSite cloud.

DHCP: – **Yes** – Selects automatic configuration of the DLC card Ethernet parameters from a DHCP server.

No – Selects manual configuration of the DLC card Ethernet parameters.

If **DHCP:** = **No**, the following prompts will be visible:

IP: – Set the IP address.

Netmask: – Set the netmask.

Gateway: – Set the network gateway setting.

Press **ENTER** to accept all inputs.

The display will show the **DLC CARD 1 CELL ASSIGNMENT** screen.

DLC Card 1 Cell Assignment

The left side of the column shows the existing programmed IDs and scale numbers assigned for each cell.

If any cells are detected on the bus that are not assigned, they will show on the right column under the **Unassigned ID** heading.

```
DLC CARD 1 CELL ASSIGNMENT

  Num   Cell ID   Scale   Unassigned ID
>  1    1D6BFF0F   1
  2    15D64531   1
  3    0B5B616F   1
  4    101BA5C1   1
  5    115DC621   2
  6    049AED9F   2
  7    0B2E2ECF   2
  8    0AF79DC1   2
  9    03573F3F   3
 10    043105FF   3
 11    120B5F6F   3
 12    090F1F4F   3

Use navigation keys to move selection
Press SPACE to configure selected item
Press 'U' to unassign selected item
```

DLC Card 1 Cell Assignment, Cont.

The right navigation key may be used to select the unassigned column. The left navigation key may be used to select the existing cell IDs. The up/down navigation keys may be used to select a specific cell.

Assign Cell

Select the next cell to assign on the right column and press the **A** key to assign it to the next unassigned cell (cell ID 00000000). The ID will then appear on the assigned list on the left.

```
DLC CARD 1 CELL ASSIGNMENT

Num      Cell ID      Scale  >  Unassigned ID
  1      1D6BFF0F      1      1      043105FF
  2      15D64531      1      2      120B5F6F
  3      0B5B616F      1      3      090F1F4F
  4      101BA5C1      1
  5      115DC621      2
  6      049AED9F      2
  7      0B2E2ECF      2
  8      0AF79DC1      2
  9      03573F3F      3
 10      00000000      3
 11      00000000      3
 12      00000000      3

Use navigation keys to move selection
Press 'A' to assign selected item to
first available cell number
```

DLC Card 1 Cell Assignment, Cont.

Cell IDs may also be entered manually and the scale to associate with the cell by selecting an item in the left column pressing the **SPACE** key.

DLC CARD 1 CELL ASSIGNMENT			
Num	Cell ID	Scale	Unassigned ID
1	1D6BFF0F	1	> 1 120B5F6F
2	15D64531	1	2 090F1F4F
3	0B5B616F	1	
4	101BA5C1	1	
5	115DC621	2	
6	049AED9F	2	
7	0B2E2ECF	2	
8	0AF79DC1	2	
9	03573F3F	3	
10	043105FF	3	
11	00000000	3	
12	00000000	3	

Use navigation keys to move selection
Press 'A' to assign selected item to
first available cell number

DLC Card 1 Cell Assignment, Cont.

Type the **Cell ID** if it is to be changed, press the down navigation key to select the **Scale:** prompt, and then enter the scale number.

```
DLC CARD 1 CELL ASSIGNMENT

Num      Cell ID      Scale      Unassigned ID
  1      1D6BFF0F      1          1  120B5F6F
  2      15D64531      1          2  090F1F4F
  3      0B5B616F      1
  4      101BA5C1      1
  5      115DC621      2
  6      049AED9F      2
  7      0B2E2ECF      2
  8      0AF79DC1      2
  9      03573F3F      3
 10      043105FF      3
> 11      00000000      3
 12      00000000      3

Cell ID: 120B5F6F
Scale:   3
```

When finished press and release the **SHIFT** key, then press the **ESC/←** key.

The display will return to the Setup Scale Number screen.



NOTE: If the DLC configuration changes have changed the number of scales the 825D, power should be turned off, and after a brief delay turn the power back on.

Select a scale to configure or calibrate:

The display will change to show the **Scale 1 - Calibration Options** screen.



IMPORTANT! Before calibrating the scale, the dead load of the weighbridge must be evenly distributed between the pair of cells in a section. Refer to the Balancing Weighbridge Dead Load section on page 56 of this manual for more instructions.

Smart Calibration

2. Smart Calibration

With the **Scale 1 - Calibration Options** screen displayed, press the **2** key, or use the Navigation Keys to select (highlight) **2. Smart Calibration**, and then press the **ENTER** key.

```
Scale 1 - Calibration Options
```

```
Press:
```

```
1. Parameters
```

```
2. Smart Calibration
```

```
3. Zero Calibration
```

```
4. Trim Load Cells
```

```
5. Span Adjust
```

```
6. DLC Diagnostics
```

```
Hardware calibration enabled
```

The display will change to show the **Scale 1 - Smart Calibration** screen.

Smart Calibration, Cont.

With the **Scale 1 - Smart Calibration** screen displayed, enter the weight value of the test weight to be used.

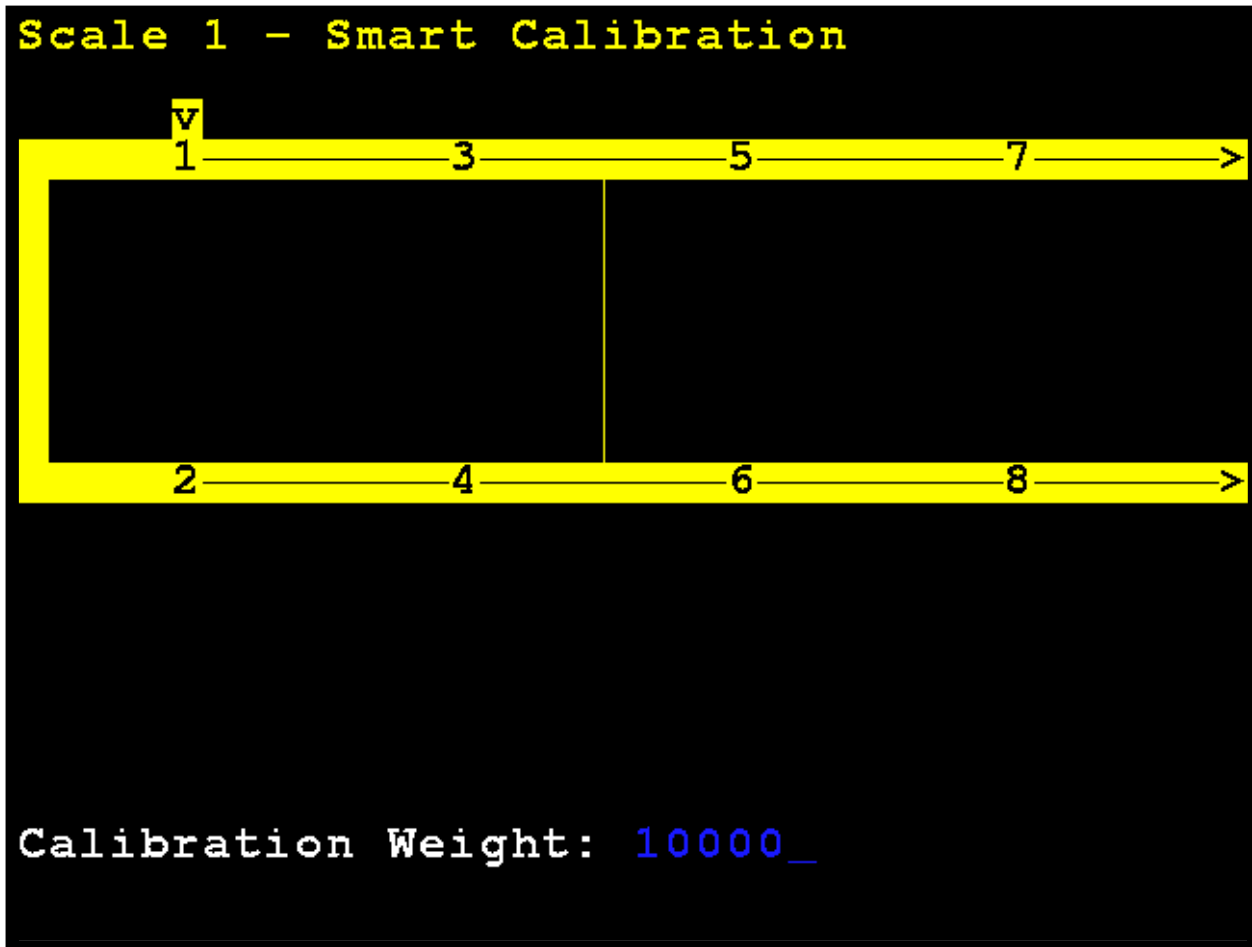

Smart Calibration, Cont.

With an empty scale, press **ENTER**. This will capture the calibrated dead load weight of the scale.

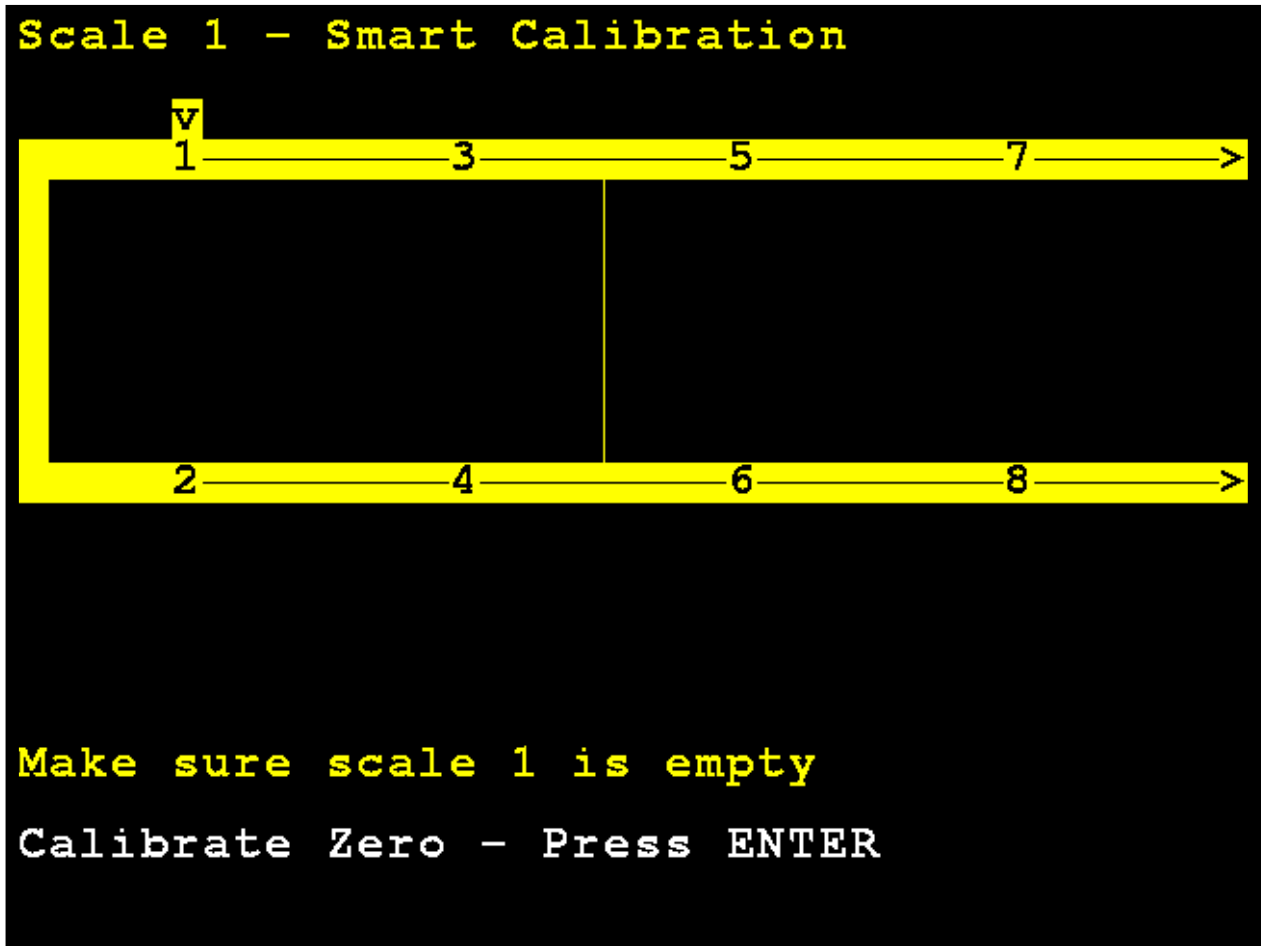

Smart Calibration, Cont.

The 825D display will change to show that it is calibrating.

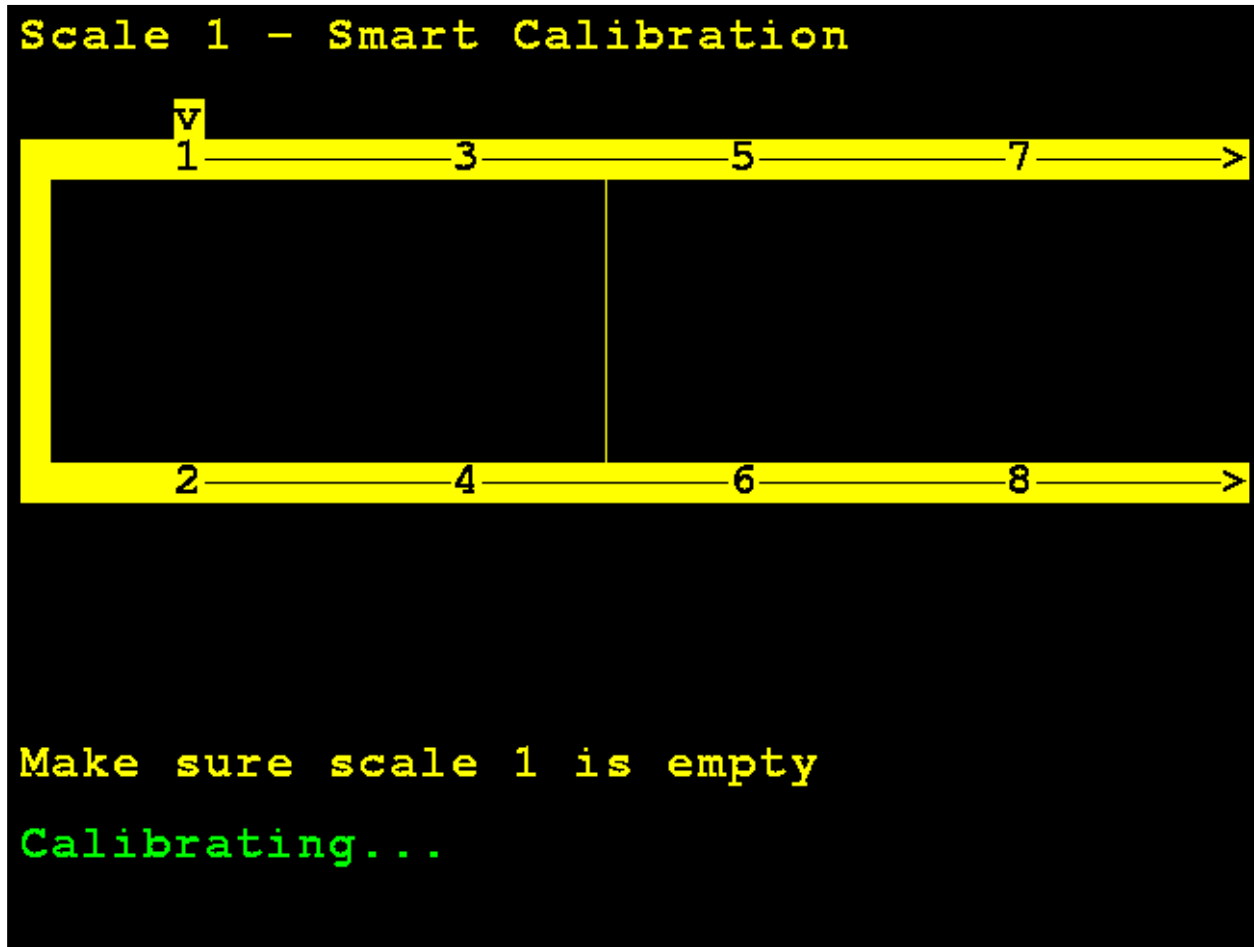

Smart Calibration, Cont.

Center the weight over load cell 1, and press **ENTER**.

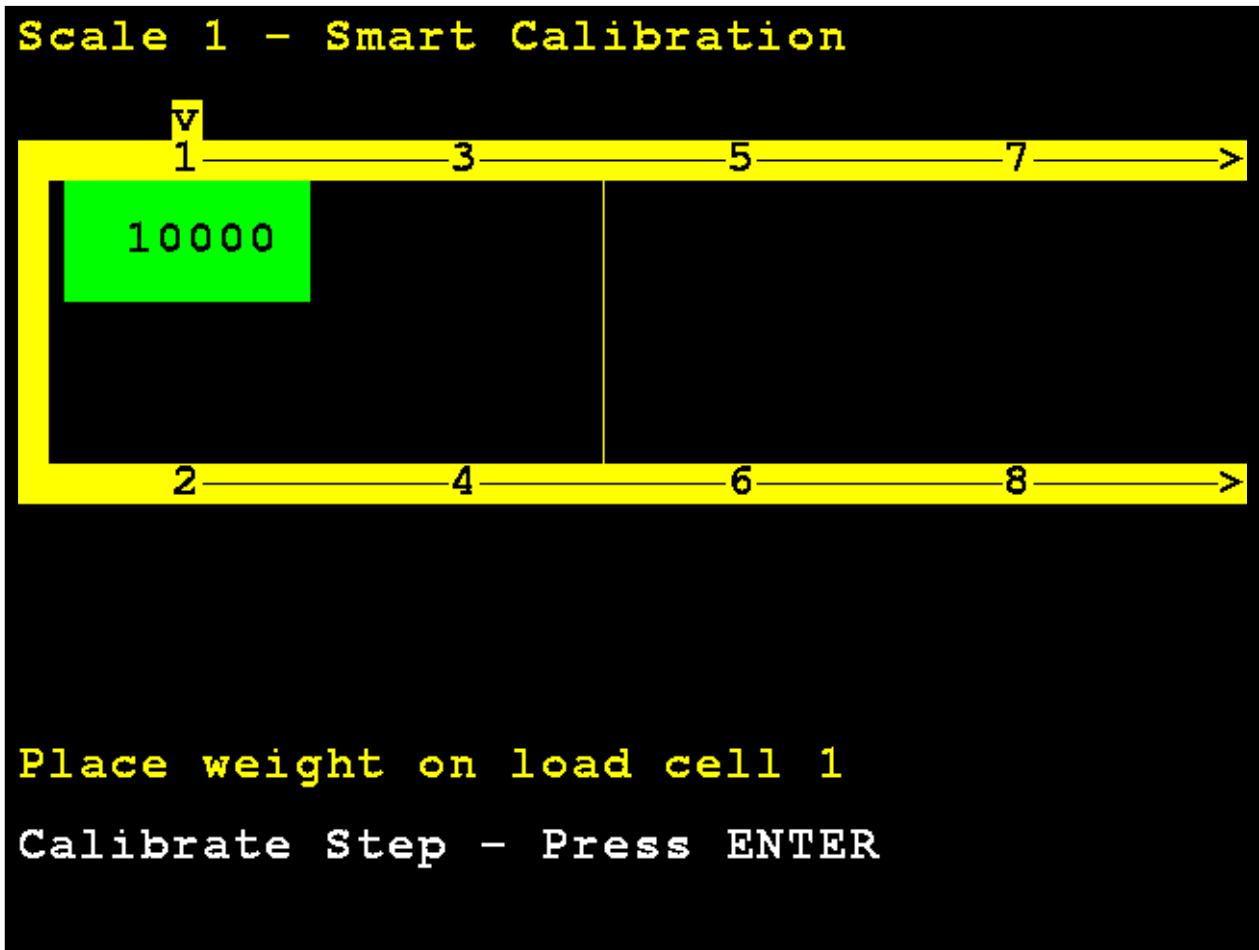

Smart Calibration, Cont.

The 825D display will change to show that it is calibrating the weight on load cell 1.

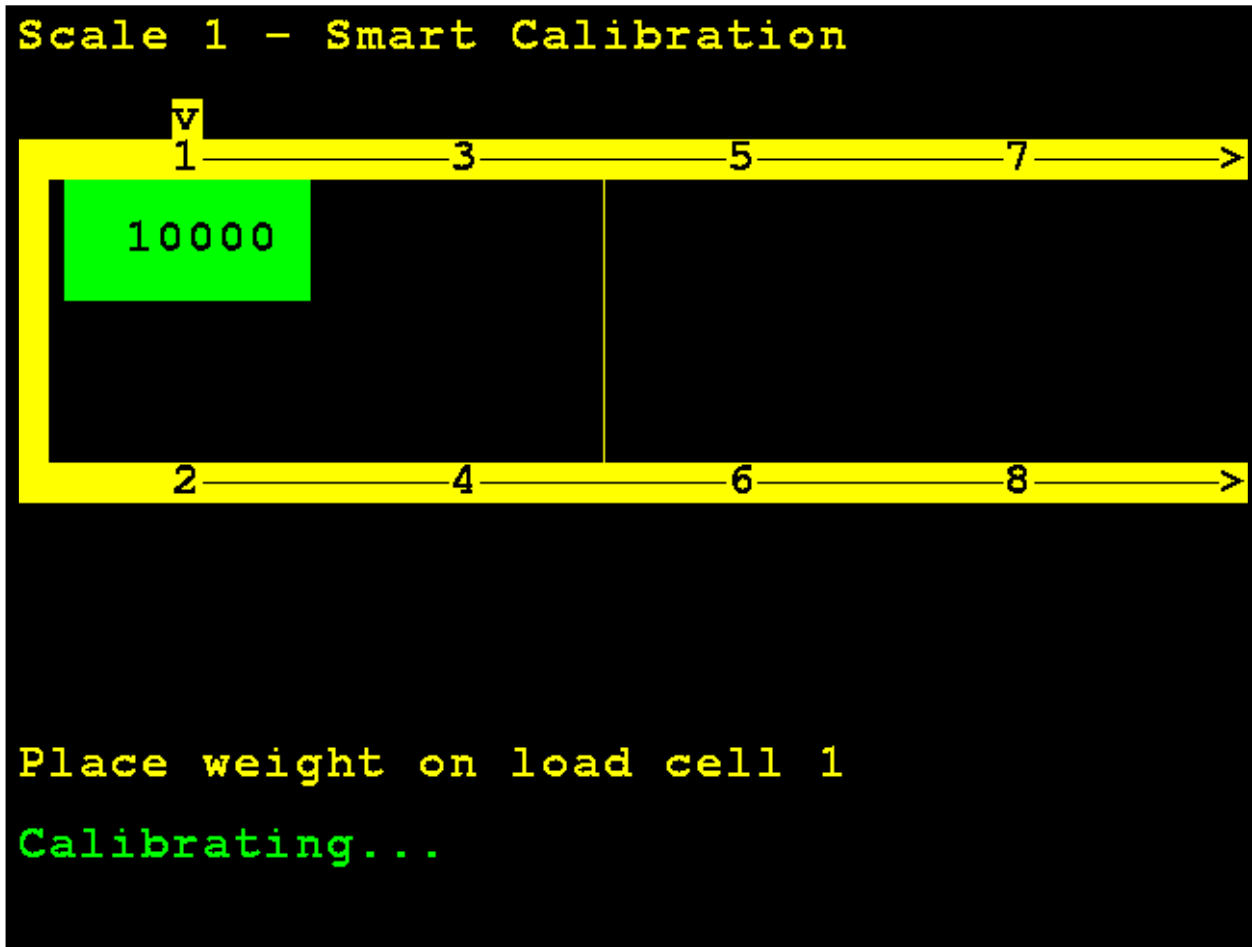

Smart Calibration, Cont.

Move the test weight and center it over load cell 2, and press **ENTER**.

The 825D display will change to show that it is calibrating the weight on load cell 2.

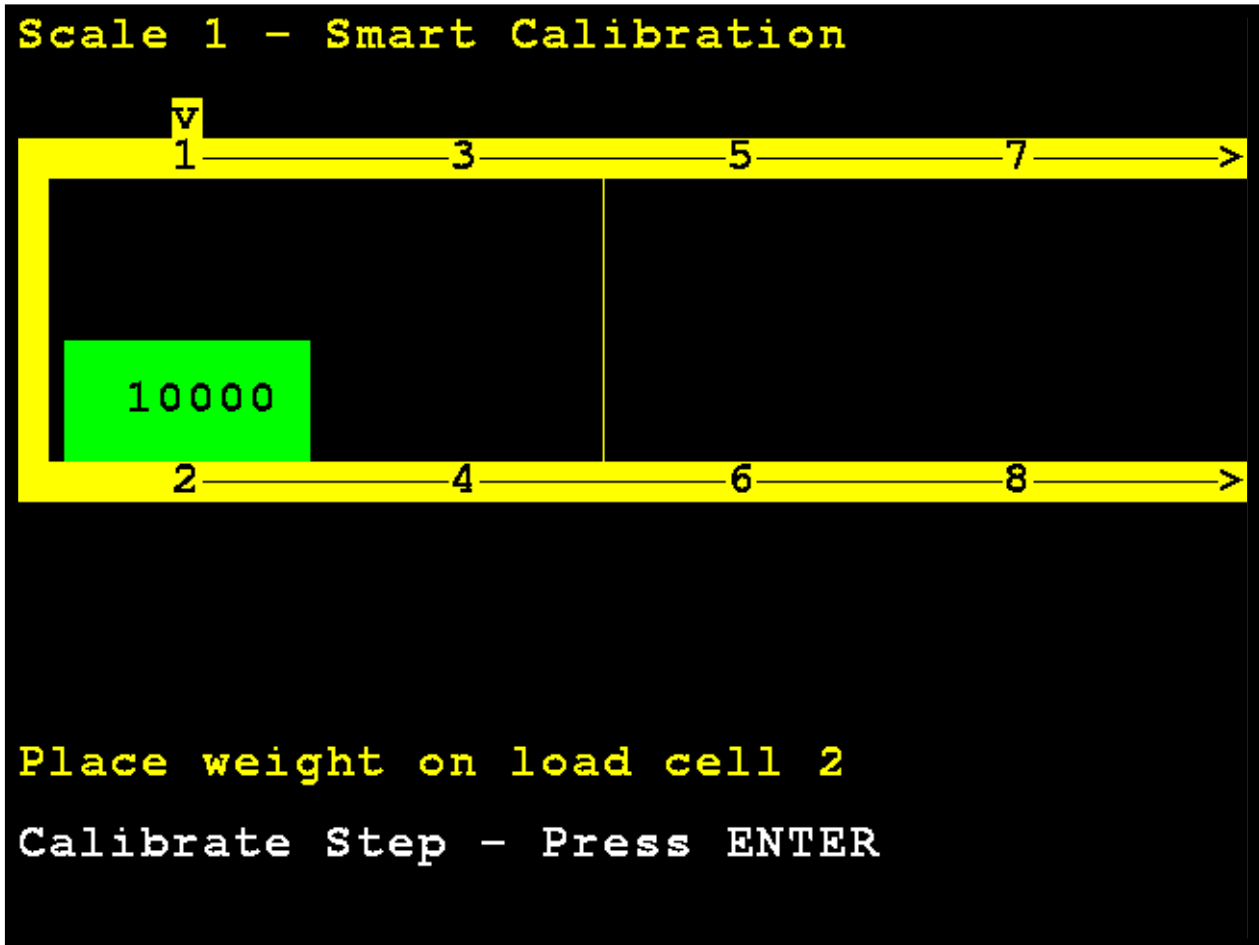

Smart Calibration, Cont.

Move the test weight and center it over load cell 3, and press **ENTER**.

The 825D display will change to show that it is calibrating the weight on load cell 3.

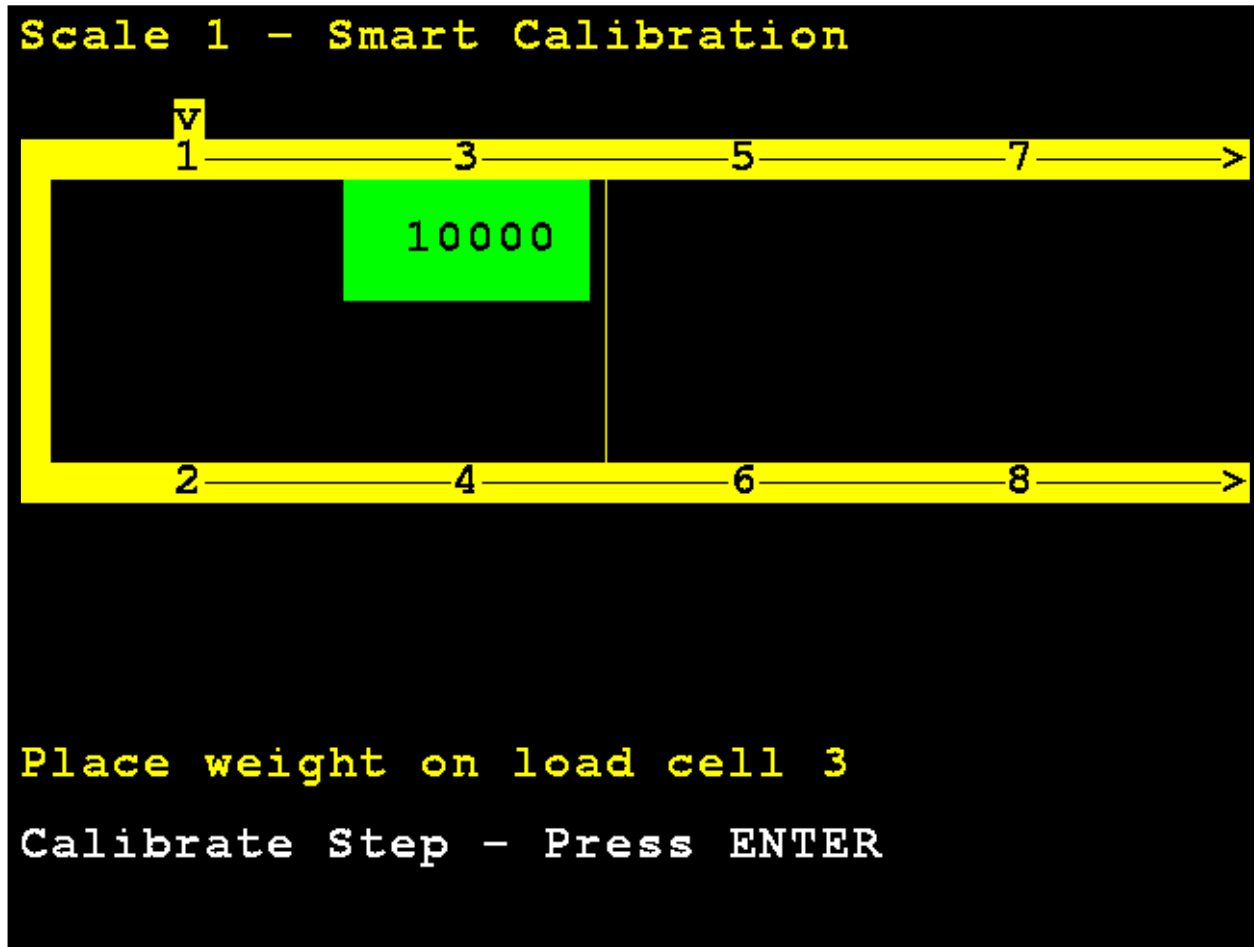

Smart Calibration, Cont.

Move the test weight and center it over load cell 4, and press **ENTER**.

The 825D display will change to show that it is calibrating the weight on the load cell.

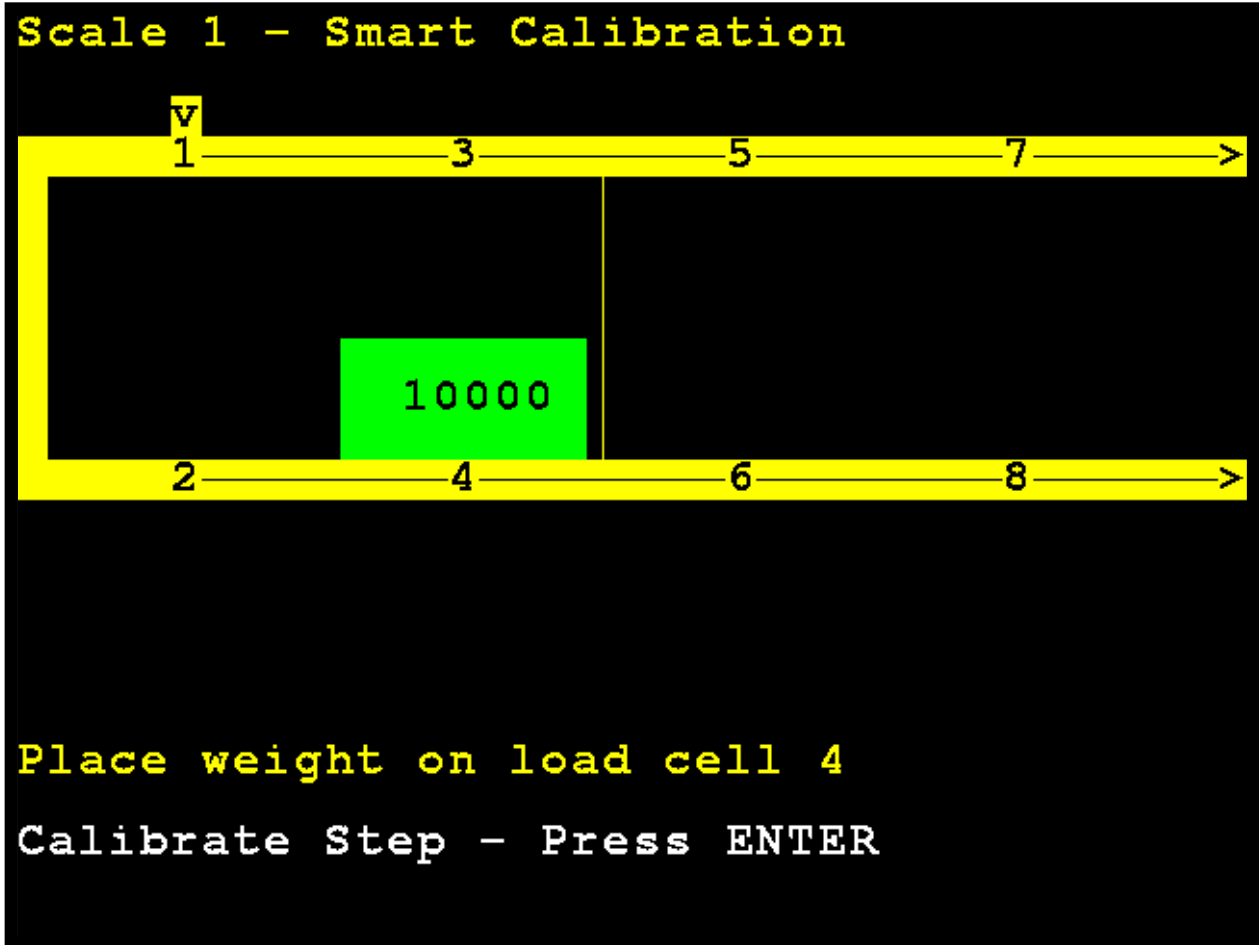

If more than four cells and the number of cells is even a number (such as for an eight-cell scale), the calibration pattern will be the odd-numbered cells, then the even-numbered cells *in reverse* to facilitate easy weight cart movement:

1, 3, 5, 7, 8, 6, 4, 2

Otherwise, the calibration pattern will be sequential:

1, 2, 3, 4, 5, 6, 7, 8

Zero Calibration

3. Zero Calibration

With the **Scale 1 - Calibration Options** screen displayed, press the **3** key, or use the Navigation Keys to select (highlight) **3. Zero Calibration**, and then press the **ENTER** key.

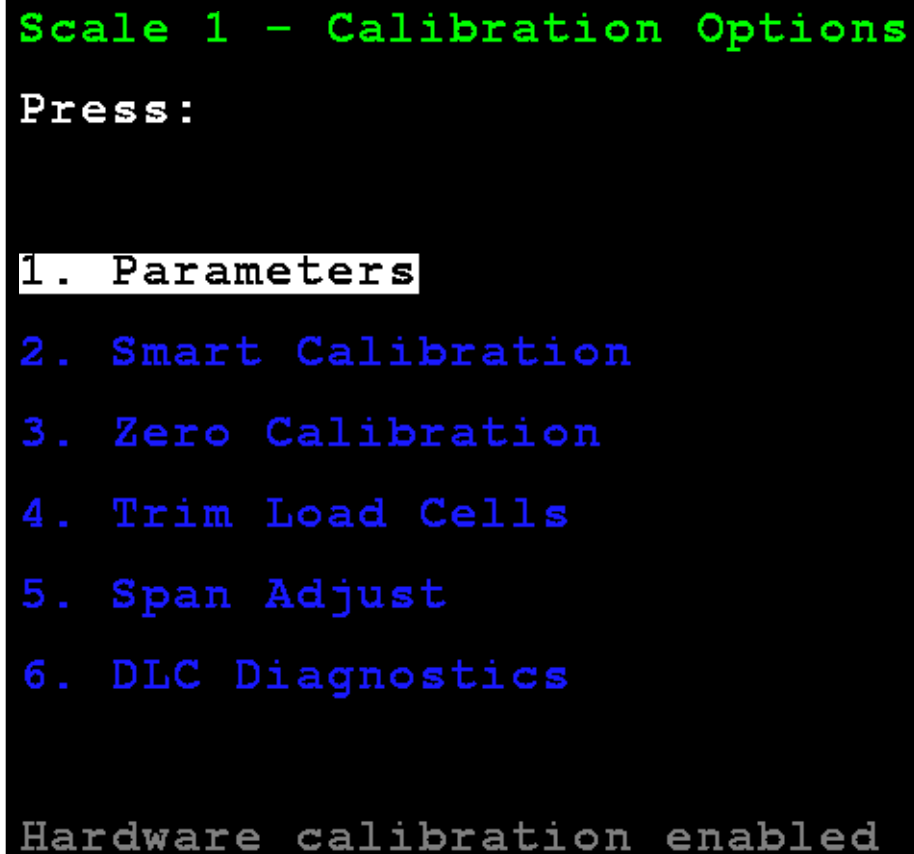

```
Scale 1 - Calibration Options
Press:
1. Parameters
2. Smart Calibration
3. Zero Calibration
4. Trim Load Cells
5. Span Adjust
6. DLC Diagnostics

Hardware calibration enabled
```

The display will change to show the **Scale 1 - Zero Calibration** screen.

Zero Calibration, Cont.

With an empty scale, press **ENTER**. Zero Calibration does not affect the trimming of the cells or affect span; it simply sets the dead load weight of the scale.

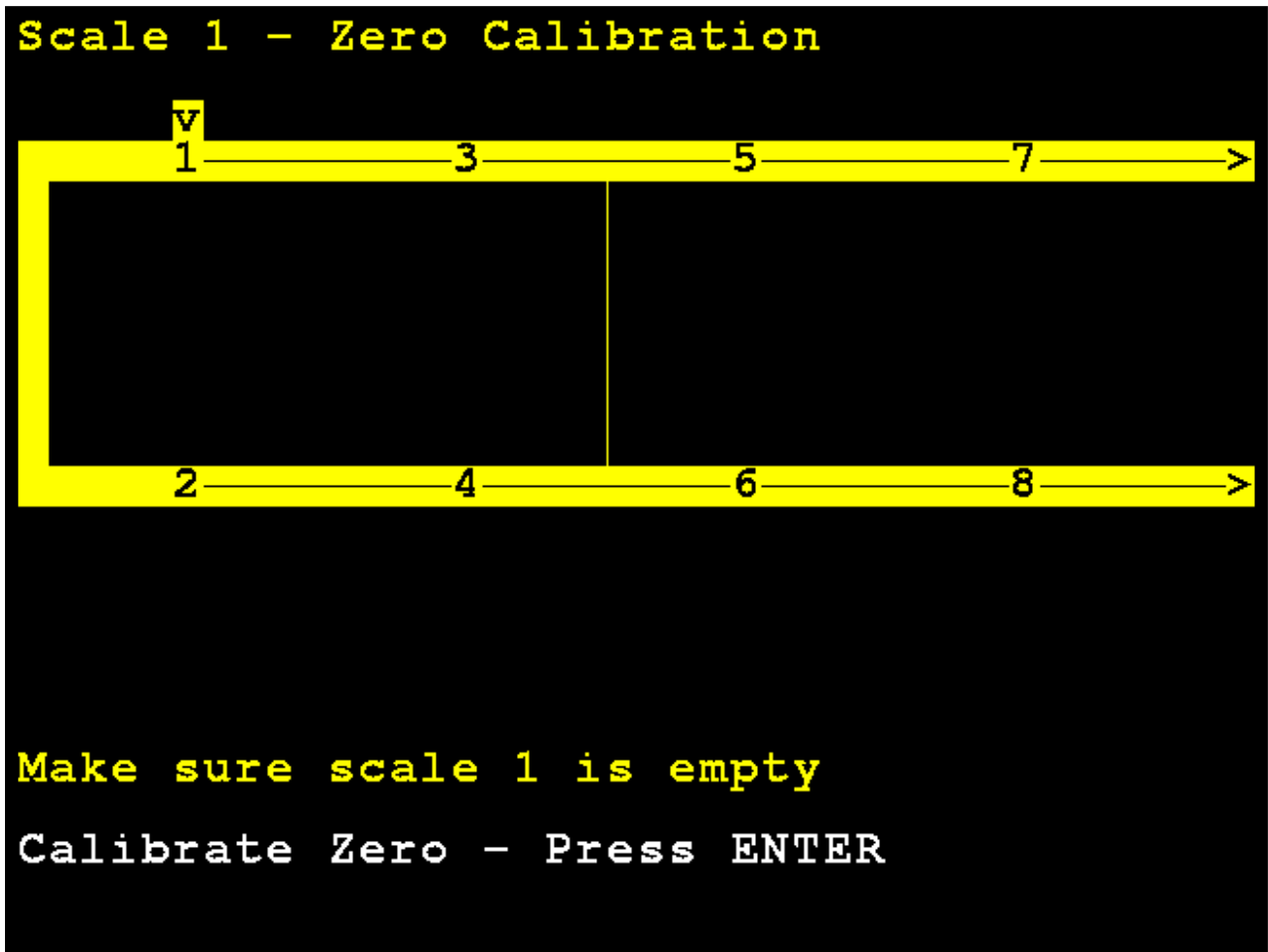

Zero Calibration, Cont.

The 825D display will change to show that it is calibrating zero.

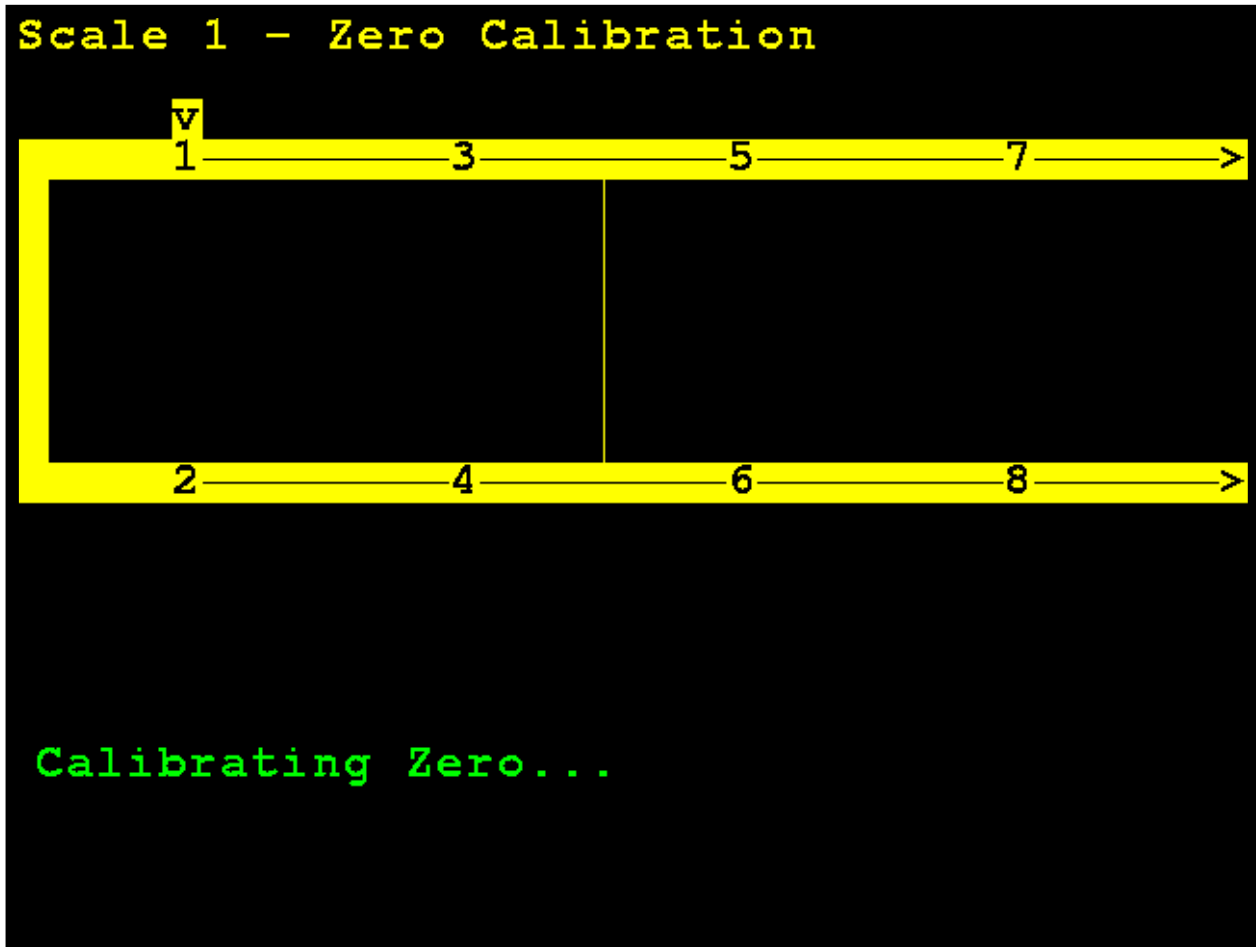

Trim Cells

4. Trim Load Cells

With the **Scale 1 - Calibration Options** screen displayed, press the **3** key, or use the Navigation Keys to select (highlight) **4. Trim Load Cells**, and then press the **ENTER** key.

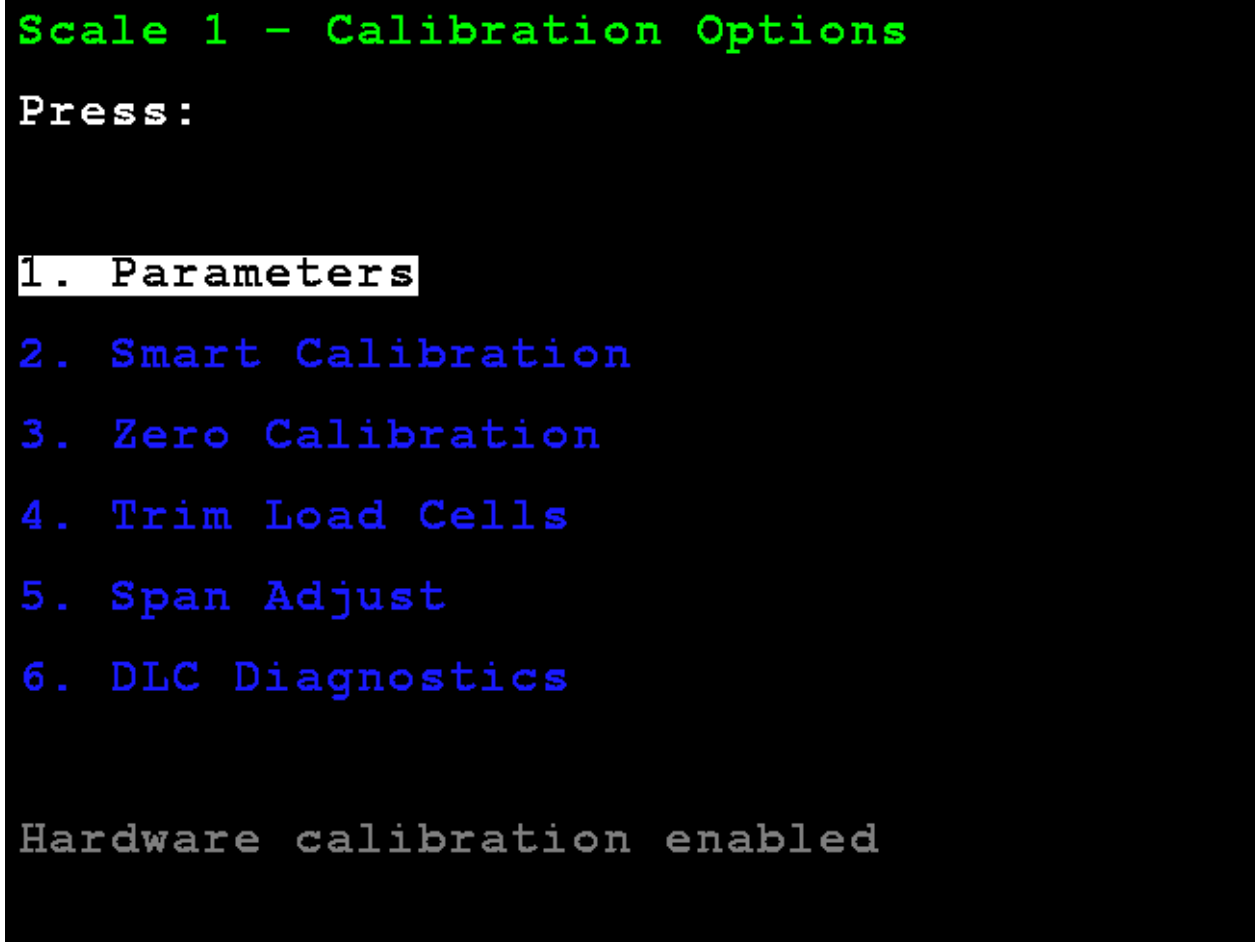

The display will change to show the **Scale 1 - Trim Cells** screen.

Trim Cells, Cont.

Section Trim Mode

Individual cells or a section (pairs of cells) may be trimmed. This requires a test load weight.

M)ode – Press the **M** key to toggle between Section or Single Cell trim. *Default is Section.*

Use the Navigation Keys to select (highlight) the section to trim.

With the desired section selected, enter the Trim Value, and press the **ENTER** key to set the weight to adjust the trim.

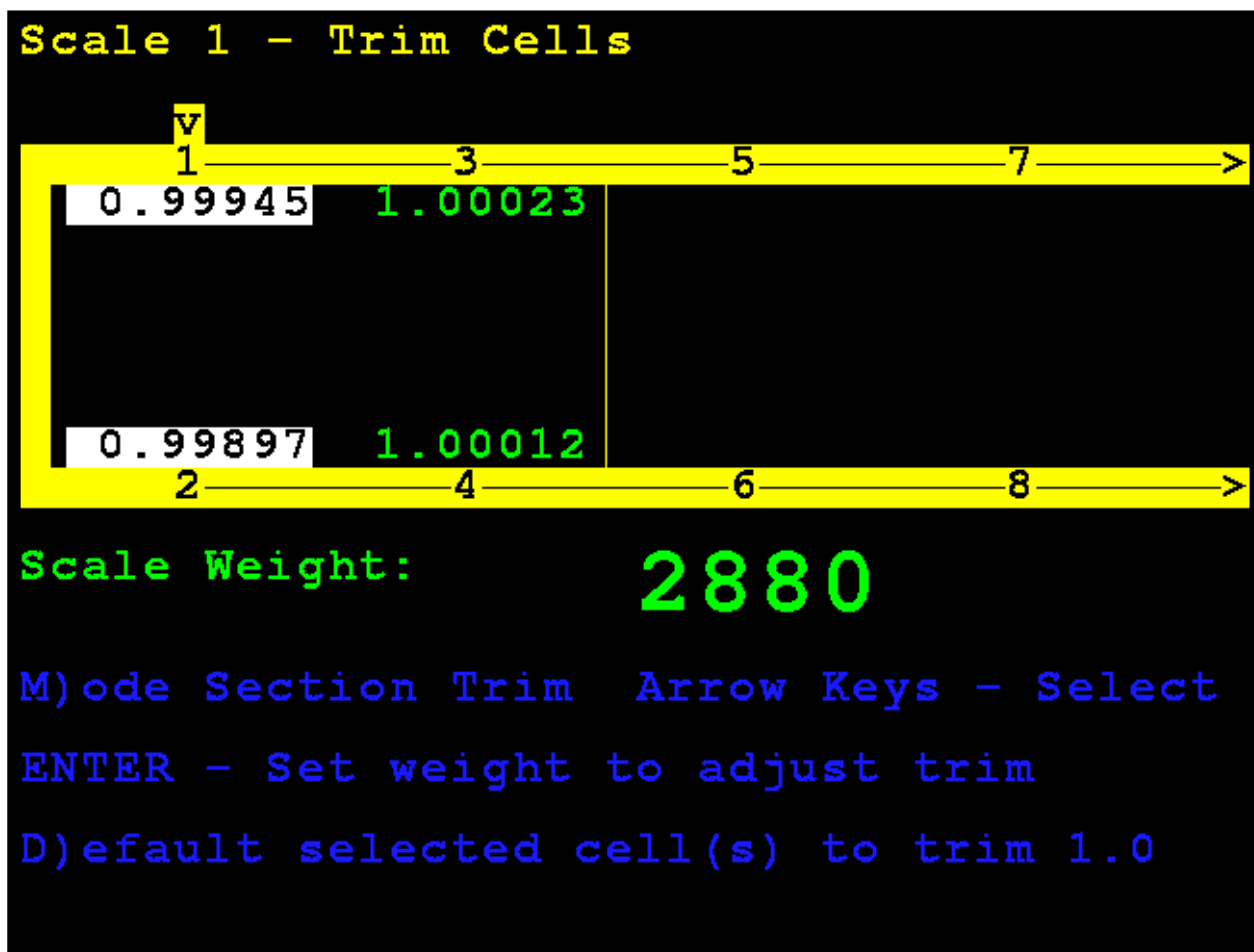

Trim Cells, Cont.

Single Cell Mode

Press the **M** key to select Single Cell trim.

Use the Navigation Keys to select (highlight) the cell to trim.

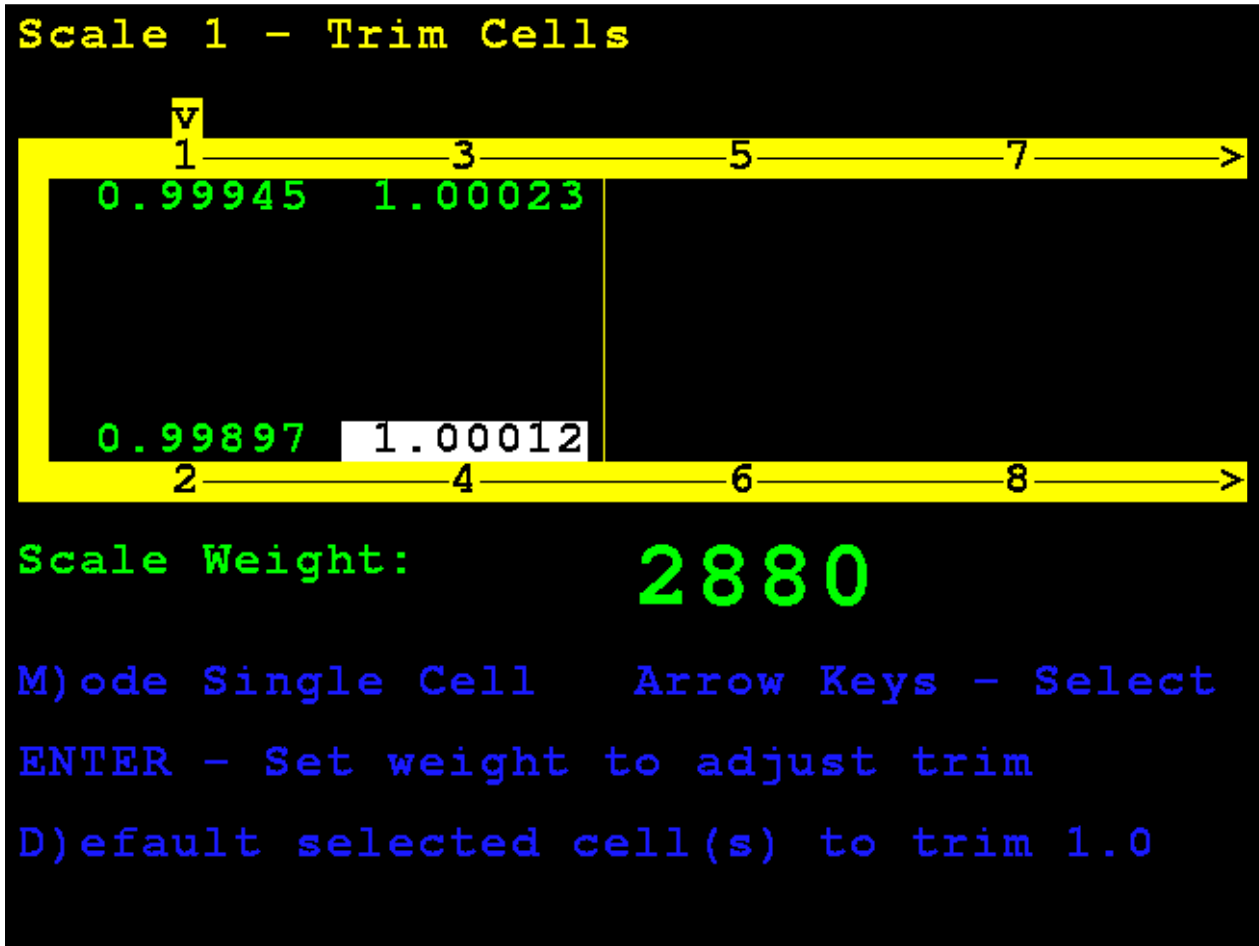

Trim Cells, Cont.

Single Cell Mode, Cont.

With the desired cell selected, enter the Trim Value, and press the **ENTER** key to set the weight to adjust the trim.

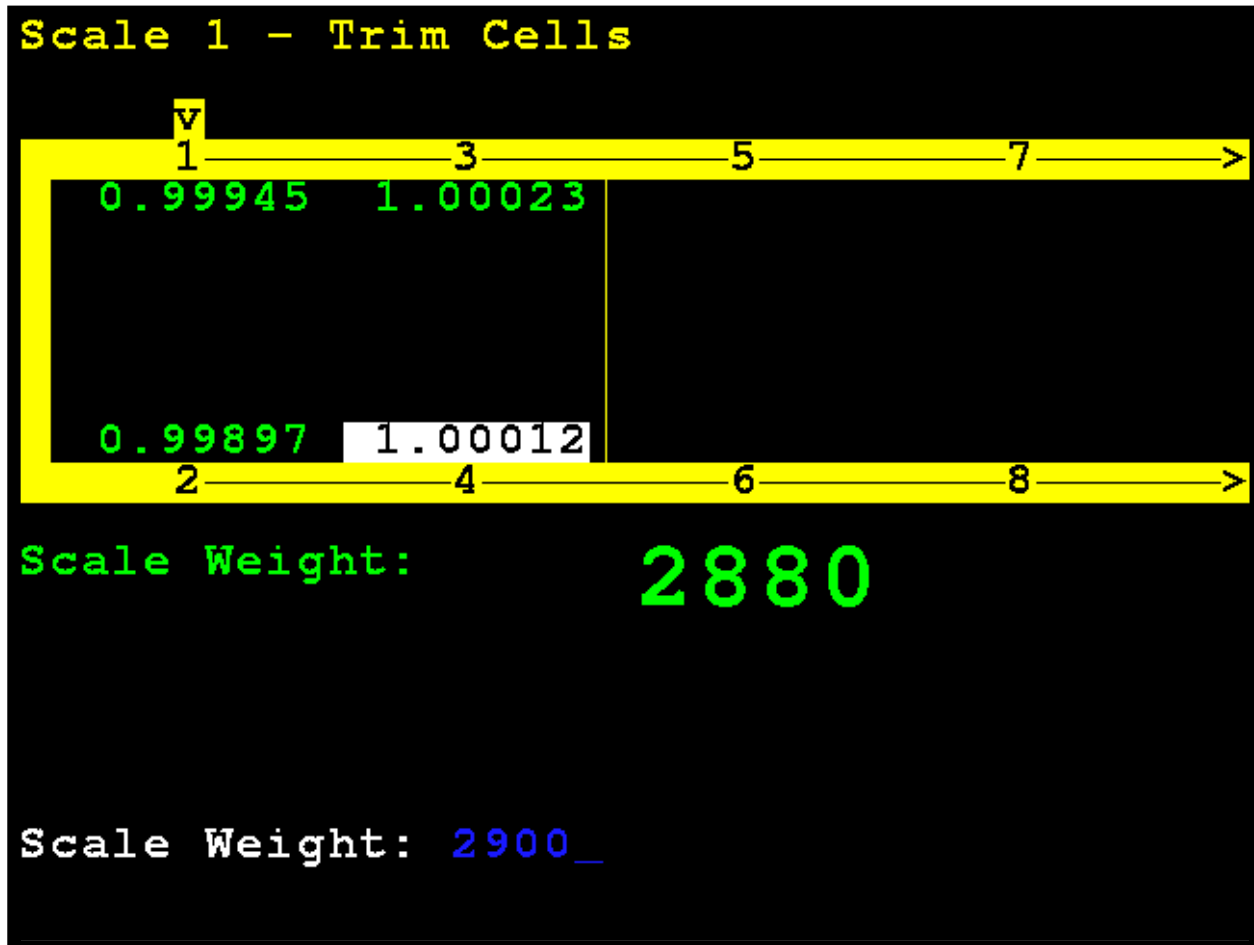

Trim Cells, Cont.

Single Cell Mode, Cont.

The 825D will automatically trim the cell to match the entered weight.

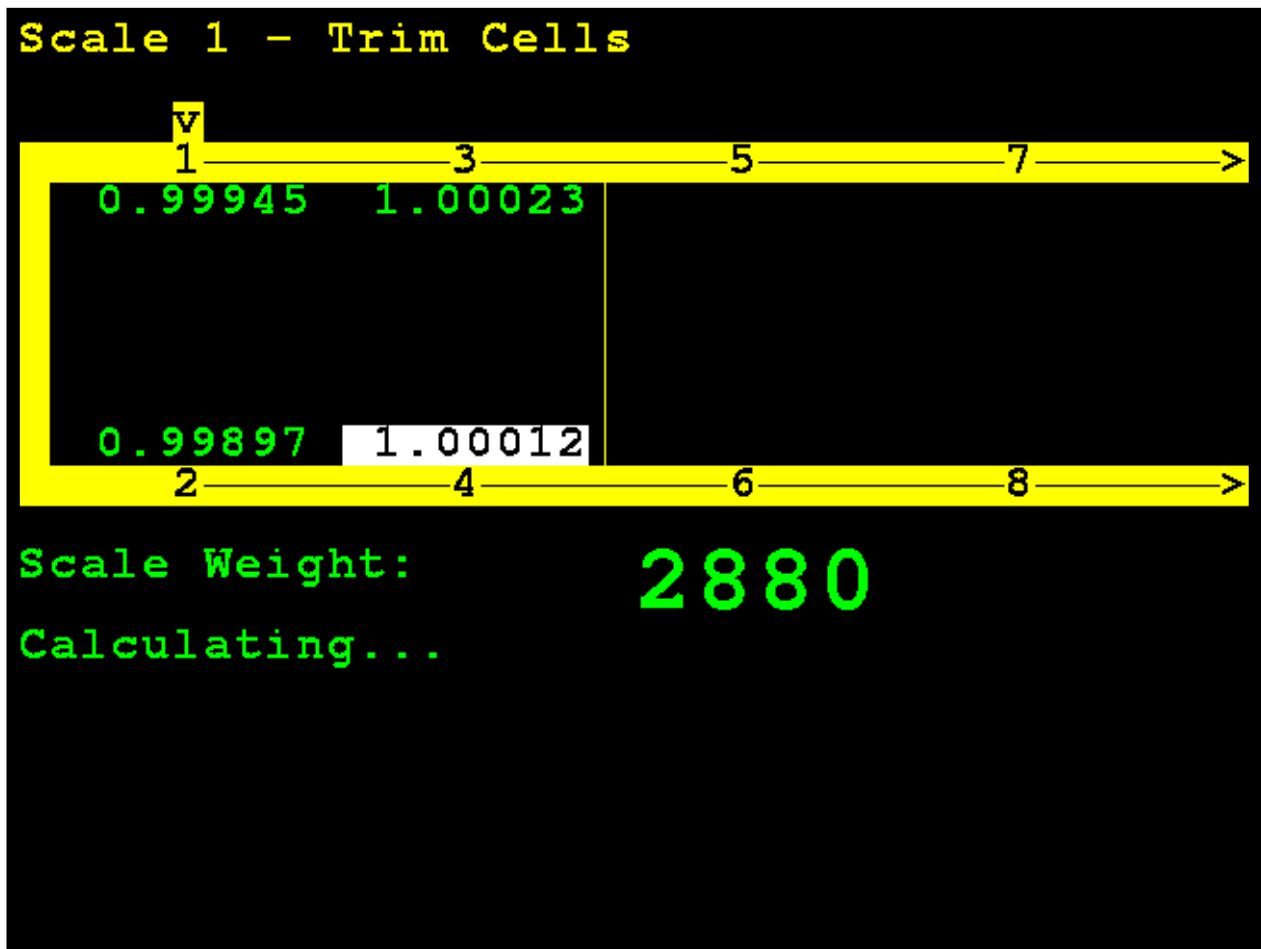

Trim Cells, Cont.

Single Cell Mode, Cont.

NOTE: If in the Single Cell mode, manually enter a trim value by pressing the **FUNCT** key, then press the (•) period key. This can be used to enter a slight adjustment, such as changing 0.98411 to 0.98421.

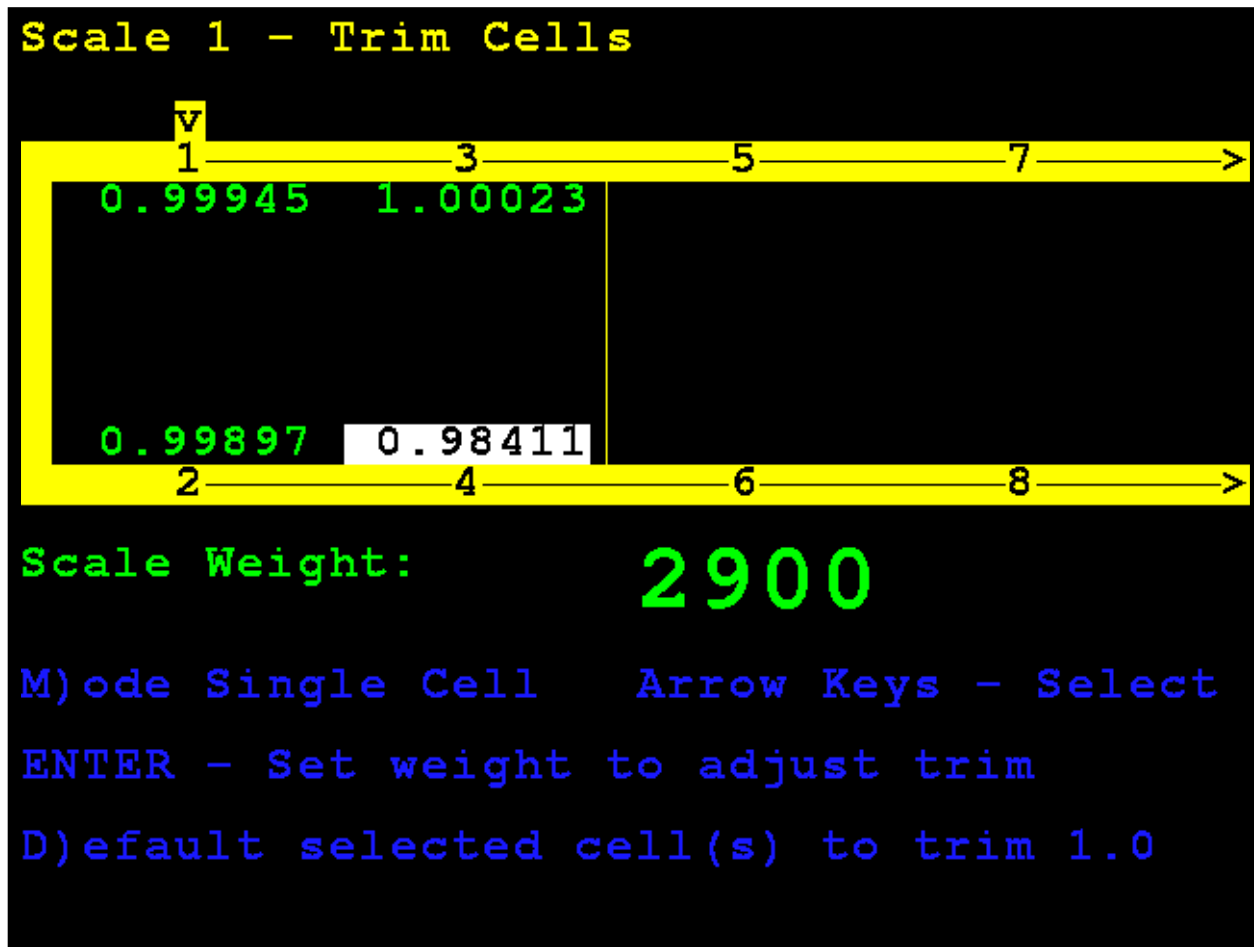

When finished, press, and release the **SHIFT** key, then press the **ESC/←** key to exit.

Span Adjust

5. Span Adjust

With the **Scale 1 - Calibration Options** screen displayed, press the **3** key, or use the Navigation Keys to select (highlight) **5. Span Adjust**, and then press the **ENTER** key.

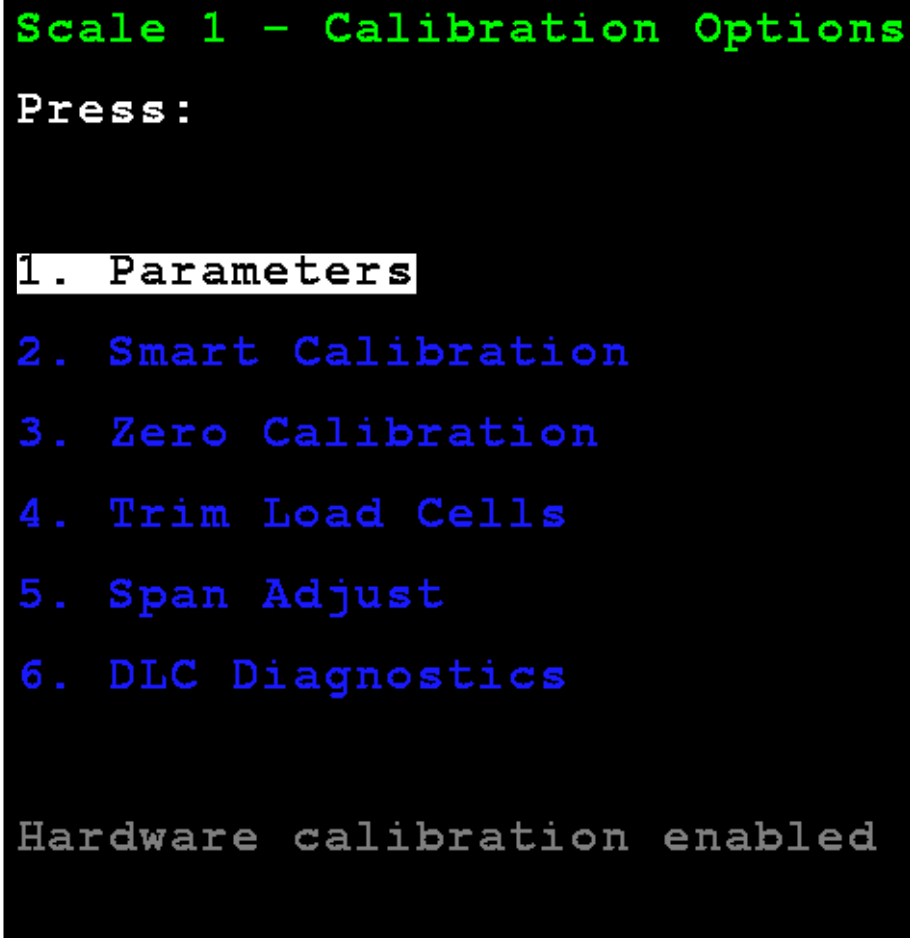

```
Scale 1 - Calibration Options
Press:
1. Parameters
2. Smart Calibration
3. Zero Calibration
4. Trim Load Cells
5. Span Adjust
6. DLC Diagnostics

Hardware calibration enabled
```

The display will change to show the **Scale 1 - Span Adjust** screen.

Span Adjust

Span adjust allows you to tweak the span of the entire scale at once.

The 825D will display the current live scale weight.

Place the test weight at any location on the scale.

Enter the value of the test weight and press the **ENTER** key.

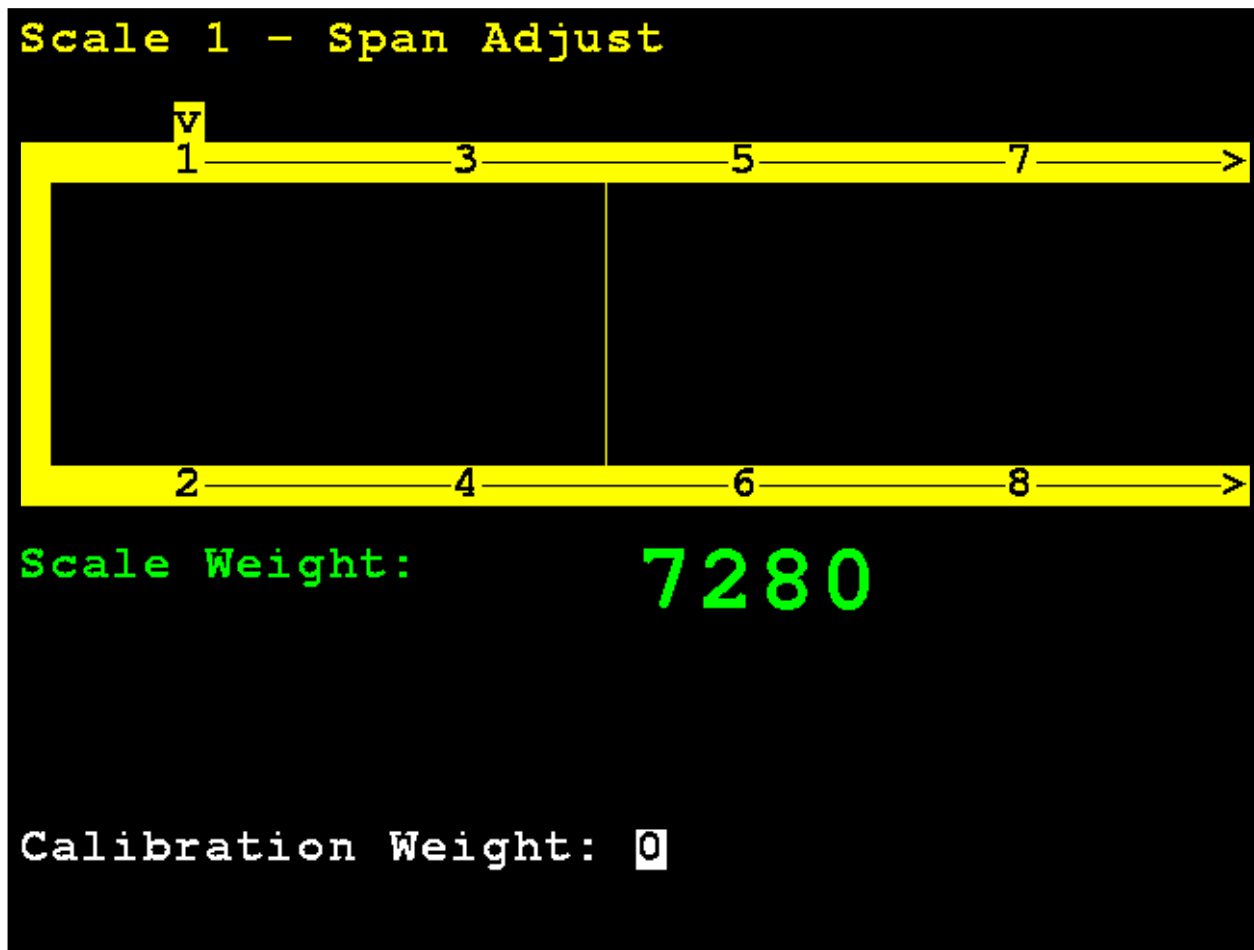

Span Adjust

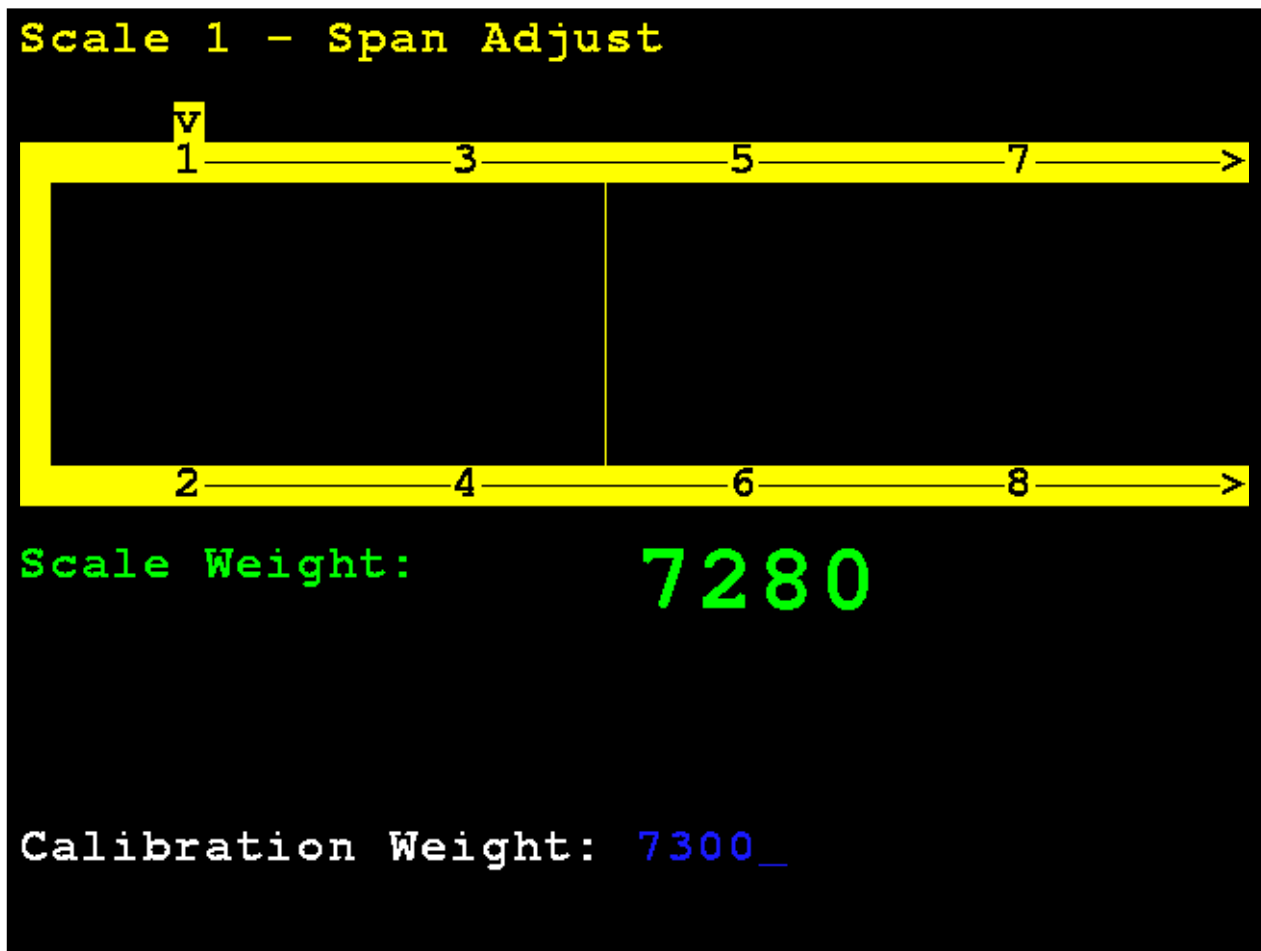

After a brief delay, the span will be adjusted (trim will be adjusted for all cells of the scale) and the 825D display will return to the **Scale 1 - Calibration Options** screen.

BALANCING WEIGHBRIDGE DEAD LOAD

Before calibration, the dead load of the weighbridge must be evenly distributed between the pair of cells in a section.

1. Begin by powering up the indicator and proceeding to the Diagnostics Menu to the LOADCELL WEIGHTS screen on the 225D or the LIVE LOAD CELL WEIGHTS on the 825D.
2. Each pair of load cells should be carrying an equal dead load of plus (+) or minus (-) 10 percent.
3. If a cell in a section has an output of less than 20 percent of the cell carrying the most load, use a hydraulic jack to lift the weighbridge off each load cell.
4. While the weighbridge is off the load cell, physically check the load cell pivot plate, and the weighbridge load cell block for any damage.
5. Install one or more 7 GA (0330-0148-08) or 10 GA (0330-0149-080) load cell shim between the load cell pivot plate, and the weighbridge load cell block until the output of the two cells are carrying an equal dead load of plus (+) or minus (-) 10 percent.



IMPORTANT! Keep in mind that all load cells should be approximately the same. When an equal dead load of plus (+) or minus (-) 10 percent on a pair of load cells cannot be obtained, this could indicate a possible defective load cell.

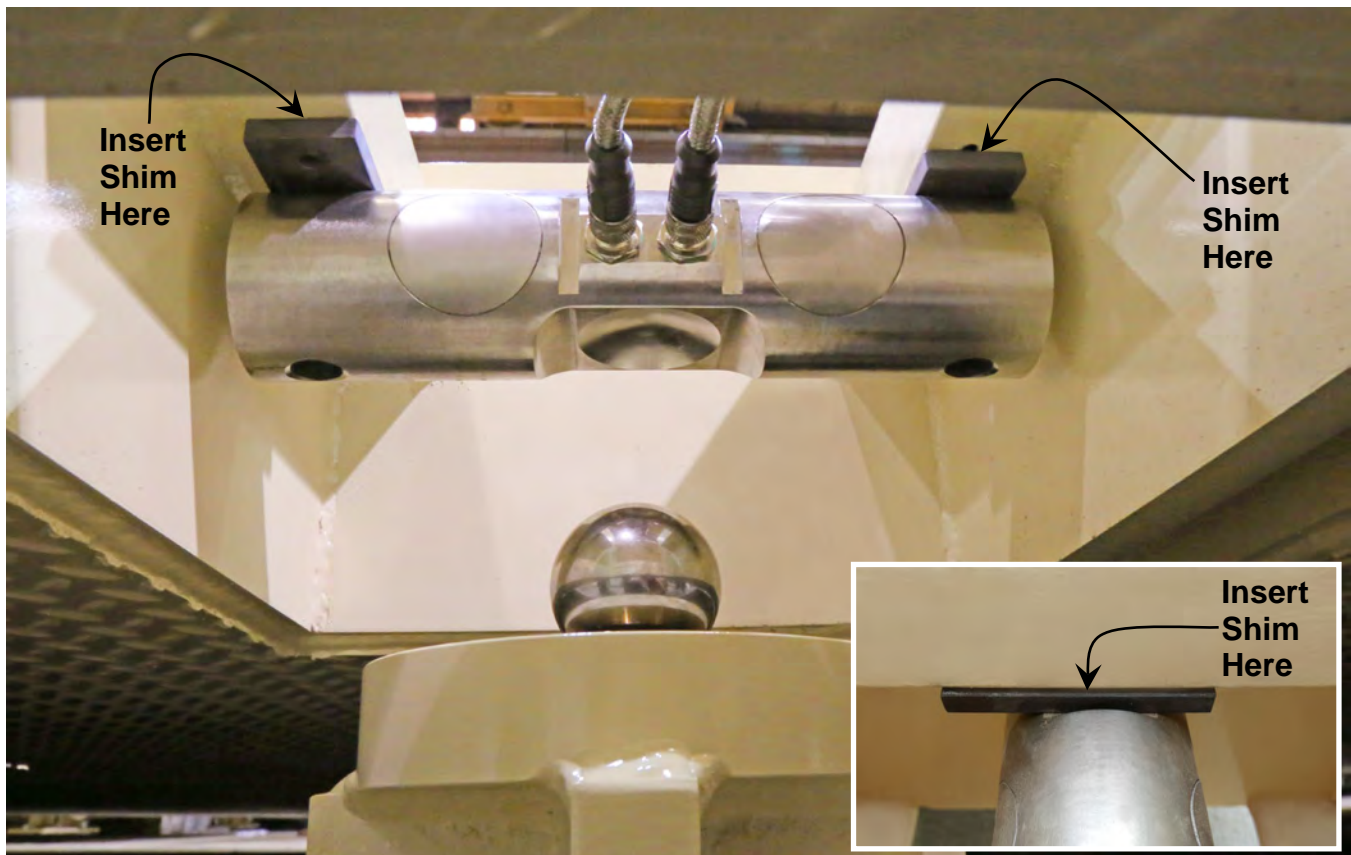

DIGITAL SCALE DIAGNOSTICS

There are three main components to the 225D and 825D Digital Scale Diagnostics:

- On Screen Diagnostics – Critical errors that alert the operator from the main screen of setup issues or hardware problems.
- Diagnostic Menu – A set of diagnostic tools that give a technician more information about each load cell.
- Hardware Diagnostics – LEDs on the DLC controller alert technicians of communications status.

225D DIGITAL SCALE DIAGNOSTICS

On Screen Diagnostics

The following messages will be shown to the operator on the main weight screen in real-time when an error happens.

COMMUNICATION ERROR BETWEEN INDICATOR AND SCALE

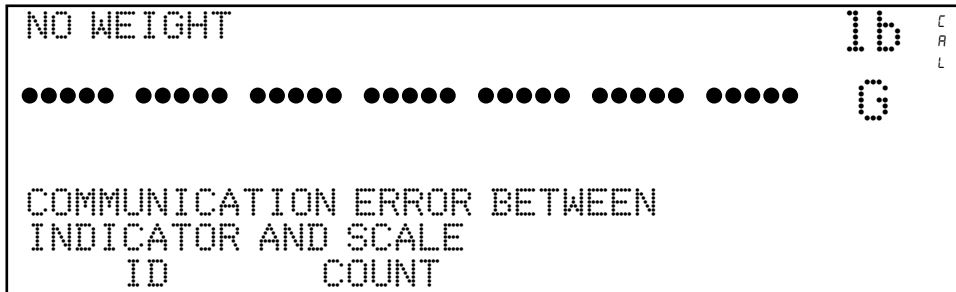

Probable Cause	Items to Check
The homerun cable is damaged or disconnected.	<ul style="list-style-type: none"> • Check that cable is connected correctly. • Check cable for damage. • Use caution on the amount of insulation stripped for the connector. Otherwise, the center wires could short. Must be shorter than the center connector. • Check connector for random strands of wire. • Verify that connector is clear of debris.

COMMUNICATION ERROR BETWEEN LOAD CELLS X AND Y

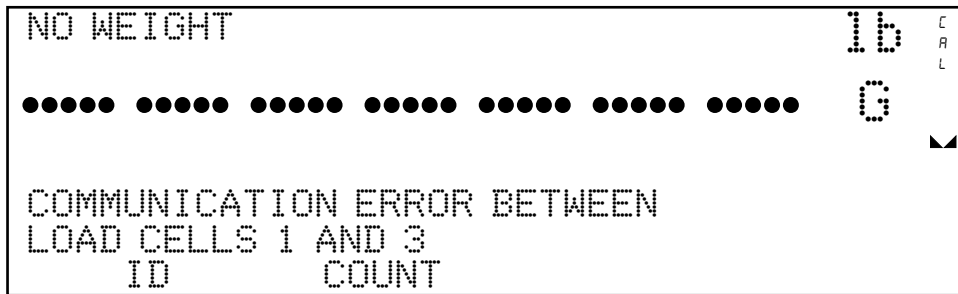

Probable Cause	Items to Check
There is a loss of communication between load cells.	<ul style="list-style-type: none"> • Check that cable is connected correctly. • Check cable for damage. • Verify that connector is clear of debris. • Check load cell COM ports on both load cells.

LOAD CELL X, Y, Z NOT RESPONDING

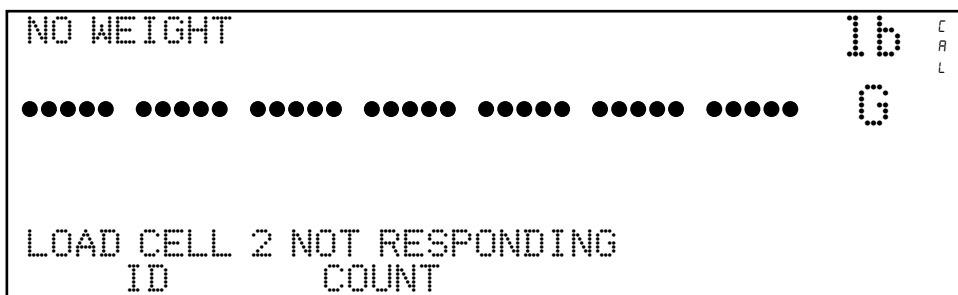

Probable Cause	Items to Check
The 225D cannot detect the exact communication problem with the unresponsive load cell.	<ul style="list-style-type: none"> • Check that cable is connected correctly. • Check cable for damage. • Verify that connector is clear of debris. • Potentially dead load cell.

LOAD CELL X DAMAGED

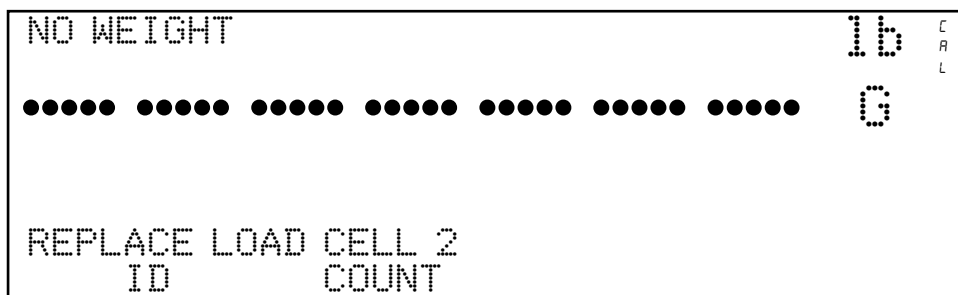

Probable Cause	Items to Check
There is irreparable internal damage to the load cell.	Replace load cell.

LOAD CELL X HAS BEEN REPLACED

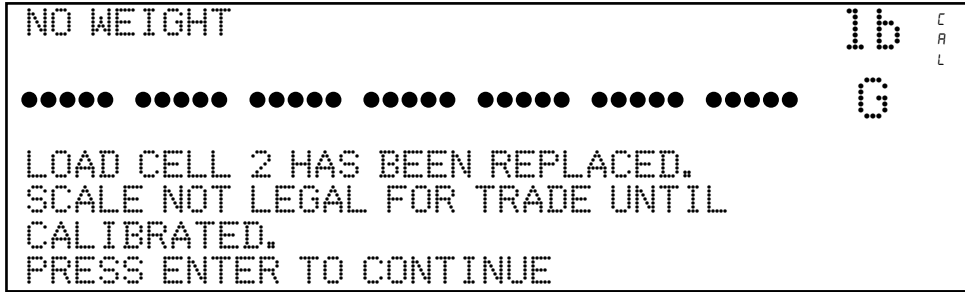

Probable Cause	Items to Check
A load cell has been replaced.	Replaced load cells are automatically detected as long as only one load cell was replaced. Once a load cell has been replaced, the 225D will auto-detect the new load cell, display the message that the scale is not Legal-For-Trade, and will need to be calibrated.

MORE LOAD CELLS THAN EXPECTED

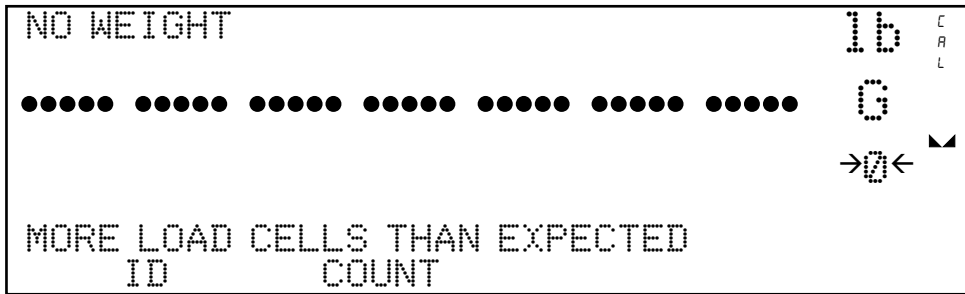

Probable Cause	Items to Check
There are more load cells than expected connected to the 225D. For example, the indicator number of load cells is set to 8 but the controller detects there are 12 load cells.	Confirm and configure the number of load cells the scale should have.

LOAD CELL ID 8F07E8F HAS NO ADDRESS

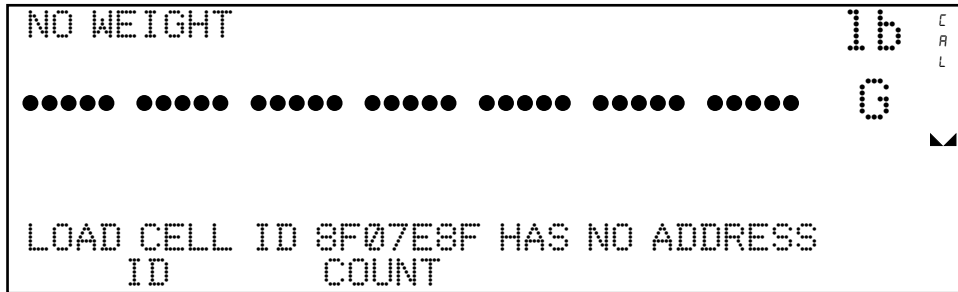

Probable Cause	Items to Check
A load cell is responding, but it is not addressed in the system.	Go to the addressing menu and assign the load cell ID to an address.

LOAD CELL ADDRESS 1 NOT ASSIGNED TO SCALE

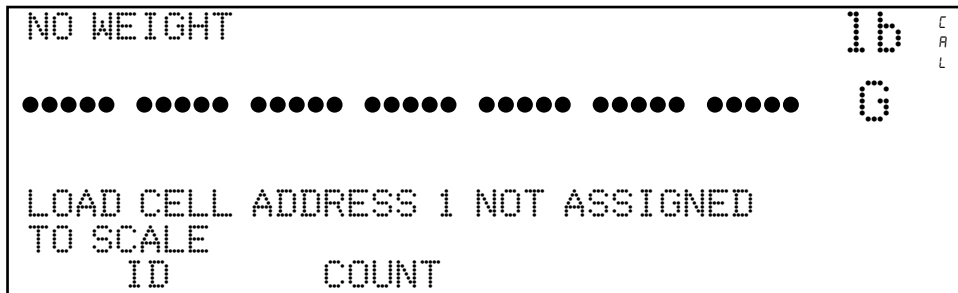

Probable Cause	Items to Check
A load cell has not been assigned to a scale.	Go to the addressing menu and assign a scale to the load cell.

LOW VOLTAGE DETECTED ON LOAD CELL X, Y, Z

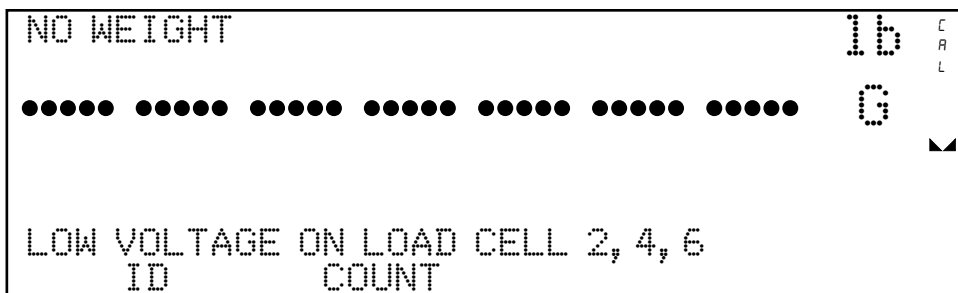

Probable Cause	Items to Check
Low power on a load cell. Load cells at the end of the CAN daisy chain are most susceptible to low voltage errors because of voltage drop along the cable.	<ul style="list-style-type: none"> • Too many load cells on the chain. • Check that cable is connected correctly. • Check cable for damage. • Verify that connector is clear of debris. • Check 225D indicator power supply.

DIGITAL SCALE BOARD NOT DETECTED

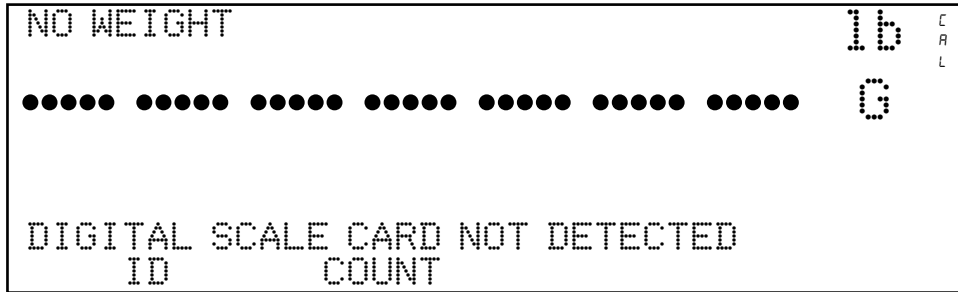

Probable Cause	Items to Check
The 225D cannot communicate with the option card or the option card is not responding.	<ul style="list-style-type: none"> • Check that the card is seated properly and fastened correctly. • Check that card is seated on the correct row of pins. • Potential of a failed card if occurs after installation and in-service.

Diagnostic Menu

To enter the diagnostic menu press **SHIFT + CELL_DIAG** soft key. All diagnostic information except the software version is updated once per second.

LIVE LOAD CELL WEIGHTS (*This can be zeroed as needed.*)

LOAD CELL WEIGHTS			
1.	225	6.	779
2.	104	7.	36
3.	-106	8.	50
4.	-120		
5.	639		
PREVIOUS		NEXT	
		EXIT	

MINIMUM AND MAXIMUM WEIGHTS (*This can be zeroed as needed.*)

MAXIMUM / MINIMUM WEIGHTS					
1.	0/	0	6.	0/	0
2.	0/	0	7.	0/	0
3.	0/	0	8.	0/	0
4.	0/	0			
5.	0/	0			
PREVIOUS		NEXT		EXIT	



Zeroing the LIVE LOAD CELL WEIGHTS and MINIMUM AND MAXIMUM WEIGHTS screens is only temporary while in diagnostics. It does not affect the scale weight working “zero”. If you exit diagnostics and return, the weights will have returned to the previous values.

DEADLOAD SHIFT

DEADLOAD SHIFT		* = CHECK LOAD CELL	
1.	-1	6	0
2.	2	7	2
3.	0	8	-1
4.	0		
5.	-3		
PREVIOUS		NEXT	
		EXIT	

This shows the live shift from the original calibrated deadload. An asterisk (*) indicates that the deadload shift has been exceeded. The scale must be empty for this to be valid.

SOFTWARE VERSION OF CELL

LOADCELL SOFTWARE VERSIONS			
1.	1.0.14	6.	1.0.14
2.	1.0.14	7.	1.0.14
3.	1.0.14	8.	1.0.14
4.	1.0.14		
5.	1.0.14		
PREVIOUS		NEXT	EXIT

NOTE: The controller's version number, in contrast, is displayed upon startup of the 225D indicator.

LOADCELL COMMUNICATION ERROR COUNTS

LOADCELL COMMUNICATION ERROR COUNTS			
1.	1	6.	0
2.	1	7.	0
3.	0	8.	0
4.	1		
5.	1		
PREVIOUS		NEXT	EXIT

DLC CARD COMMUNICATION ERROR COUNTS

DLC CARD COMMUNICATION ERROR COUNTS	
Overflow	0
Bus Off	0
CAN Err	0
PREVIOUS	
NEXT	
EXIT	

Overflow	This is the count of any missed messages from the DLC card buffer that were not kept up with. This should not happen unless too many cells are connected with too high of a sample rate.
Bus Off	This does not happen if you completely disconnect the home run cable but does count up if V+ or V- is disconnected.
CAN Err	This counts for any of the following errors:

WEIGHT ERROR COUNTS

WEIGHT ERROR COUNTS			
1.	0	6.	0
2.	0	7.	0
3.	0	8.	0
4.	0		
5.	0		
PREVIOUS		NEXT	EXIT

LOAD CELL TEMPERATURES

LOAD CELL TEMPERATURES			
1.	-49.00	6.	-49.00
2.	-41.00	7.	-41.00
3.	-41.00	8.	-41.00
4.	-41.00		
5.	-41.00		
PREVIOUS		NEXT	EXIT

CELL POWER SUPPLY VOLTAGES

CELL POWER SUPPLY VOLTAGES *Approx.			
1.	14.355	6.	14.191
2.	13.950	7.	14.530
3.	14.334	8.	14.260
4.	14.211		
5.	14.267 *		
	0.184 Amps		
PREVIOUS		NEXT	EXIT

NOTES:

- The * on cell number 5, indicates the cell voltage measurement was not calibrated but is an approximate value based on the raw counts.
- The 0.184 Amps in this example, shows the approximate current draw from the DLC for all of the cells. Unless an external power is being used, the more cells that are connected, the larger this number will be.

CELL SIGNAL MILLIVOLTS

CELL SIGNAL MILLIVOLTS			
1.	7.984	6.	1.601
2.	0.492	7.	0.561
3.	-0.085	8.	0.139
4.	-0.381		
5.	0.869		
PREVIOUS		NEXT	
		EXIT	

SNAP COMMUNICATIONS DIAGNOSTICS

When the SNAP SmartMedia Box communications are enabled, an additional page of the Digital Scale Diagnostics is available.

This will scan and list the IDs of any SmartMedia boxes that it finds on the same channel that the indicator is set to.

This screen shows the ID of the SmartMedia Box, the channel that is being used, and the signal strength detected at the SnapComD and SmartMedia Box.

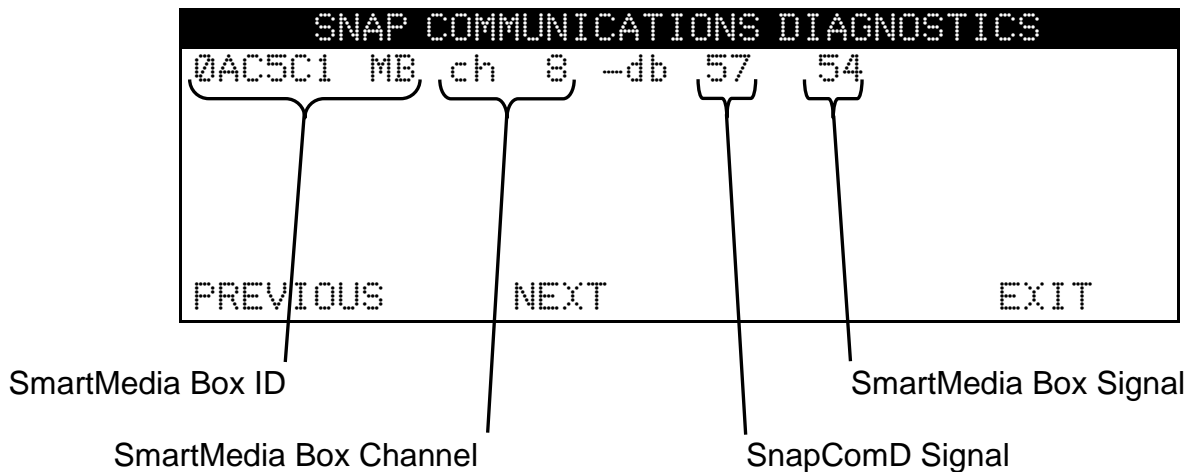

NOTE: The -db numbers are the signal strength detected at the SnapComD and SmartMedia Box. Lower numbers indicate better signal strength.

Hardware Diagnostics

The 225DLC (Digital Load cell Controller) option card has four LEDs for diagnostic purposes.

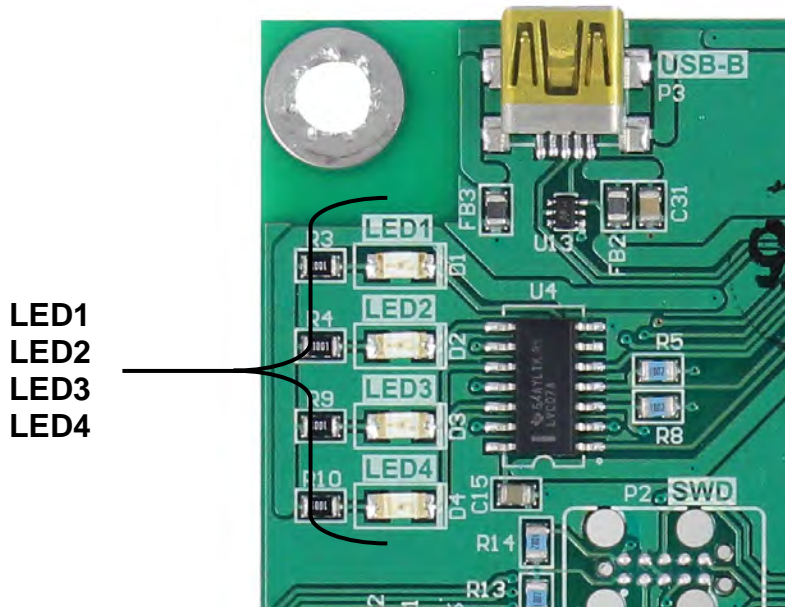

LED1 (RED) – MAIN BOARD TX/RX: Toggles each time the DLC controller and the 225D Mainboard exchange messages.

LED2 (RED) – TX TO LOAD CELL: Toggles each time a message is sent from the DLC controller to the load cells.

LED3 (RED) – RX FROM LOAD CELL: Toggles each time the controller receives a response from some or all of the load cells. Blinking does not mean that it got a response from EVERY load cell. If some load cell does not respond, the 225D will drop into INIT MODE.

LED4 (GREEN) – MODE: Indicates the mode of the DLC Controller

INIT MODE – Blinks once per second. If the 225D drops into INIT MODE, it is because setup is required, or it cannot find all the load cells.

NORMAL MODE – solid ON

DIAGNOSTIC MODE – Blinks twice per second. This should happen when the operator enters the diagnostics menus.

DETECTING 225D BOARD REPLACEMENTS

The 225D will detect when a 225DLC digital controller card or 225D mainboard has been replaced using checksums and unique board identification numbers. Based on several parameters it can detect whether the option card was replaced, or the mainboard was replaced and then reconfigure the NEW card to the existing scale.

225DLC DIGITAL CONTROLLER CARD REPLACEMENT

If an option card is replaced, the 225D will boot up to this screen:

```

                                DLC
                                BY CARDINAL
                                Revision 0.1.04
NEW CARD FOUND!
WAS DIGITAL SCALE CARD REPLACED?  NO
                                YES                                NO
```

The 225D indicator will check whether the option card has been replaced in order to reconfigure the new option card to the existing scale.

If the operator selects YES, then the 225D mainboard will upload the scale configuration to the controller and the indicator will immediately be able to make weight again.

225D MAIN PCB REPLACEMENT

If a 225D main board is replaced, the 225D will boot up to this screen:

```

                                DLC
                                BY CARDINAL
                                Revision 0.1.04
NEW CARD FOUND!
WAS MAINBOARD REPLACED?  NO
                                YES                                NO
```

The system will also check whether the 225D's mainboard has been replaced, so the scale configuration can be downloaded from the controller to the mainboard.

If the operator selects YES, then the scale configuration will be downloaded from the controller to the mainboard. Scale configuration includes the number of load cells, all load cell IDs, and individual load cell trim. Indicator parameters will need to be entered manually (Interval, Decimal Point Position, Zero Tracking, Filtering, Print Settings, Serial Settings).

NOTE: A dead load calibration will need to be performed (does not require test weights).

225DLC Digital Controller Card Replacement

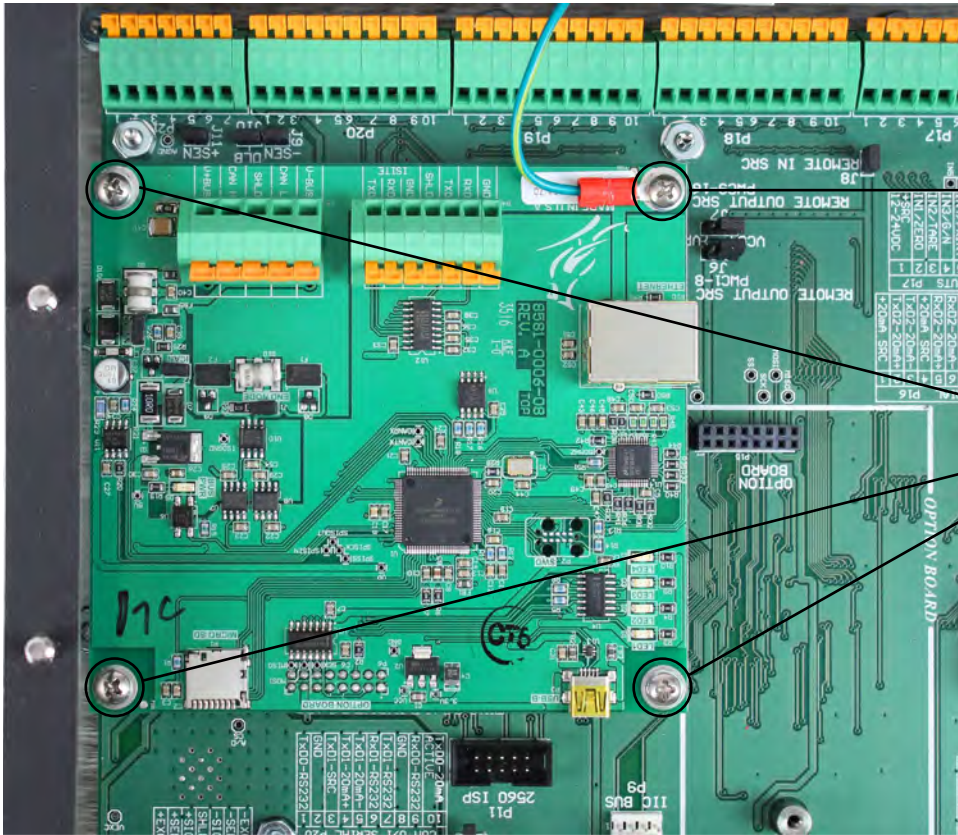

Remove this screw, washer, and the ground wire

Remove the remaining three screws and lock washers

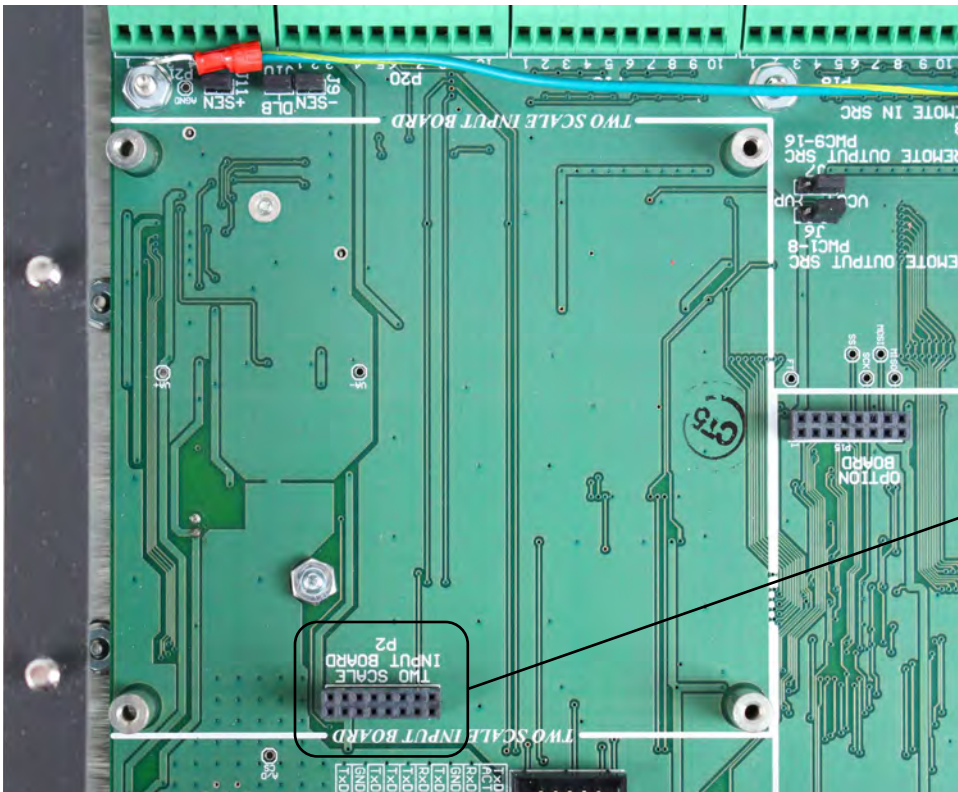

Align pins on 225DLC card with holes in P2.



CAUTION! OBSERVE THE PRECAUTIONS FOR HANDLING STATIC SENSITIVE DEVICES

1. Remove the 225D power cord from the wall outlet.
2. Remove the fourteen acorn nuts securing the rear panel to the main housing.
3. Lift the rear panel from the main housing, taking care not to stretch the cable and wires between the panel and main housing. Lay the rear panel on the workbench/table next to the indicator. **NOTE:** You may need to loosen the gland connectors to allow enough slack in the cable and wires to avoid stretching them.
4. Disconnect the Homerun cable wires from the 225DLC card.
5. Remove the four screws and washers securing the 225DLC card to the 225D mainboard. Note that the ground wire for the card is secured by one of these screws.
6. Gently rock the 225DLC card from side to side while pulling up to remove it.
7. To install the new 225DLC card, carefully align the dual row of pins on the top of the 225DLC card (on the trace side of the card) with connector P2 on the mainboard and apply even downward pressure to the edge of the 225DLC card.
8. Align the holes in the 225DLC with the threaded mounting spacers on the mainboard.
9. Secure the 225DLC card to the mainboard, using the four screws and washers removed earlier. Note that one screw and washer should be inserted through the ground wire ring terminal, before using it to secure the card to the mainboard.
10. Reconnect the Homerun cable wires.
11. Ensure that no cables or wires are exposed between the main housing and the rear panel, and then place the rear panel onto the main housing and secure it using the fourteen acorn nuts removed in step 2.
12. Re-insert the 225D power cord into the wall outlet.
13. Press the **ON/OFF** key on the 225D keypad to turn on the indicator.
14. The 225D will boot up to this screen:

```
          DLC
        BY CARDINAL
      Revision 0.1.04
NEW CARD FOUND!
WAS DIGITAL SCALE CARD REPLACED?  NO
      YES                               NO
```

15. The 225D will check whether the option card has been replaced, in order to reconfigure the new option card to the existing scale.
16. If the operator selects YES, then the 225D mainboard will upload the scale configuration to the controller, and the 225D will immediately be able to make weight again.

225DLC Controller (Digital Scale) Card

USB-B Port

Micro SD Card Slot

LED1
LED2
LED3
LED4

J1 End Node

Ethernet Port for iSite

J2, J3 ICAN Jumpers

Attach Ground wire here

P5 Homerun Cable

P4 P4 – Legacy
Future Use Serial iSite

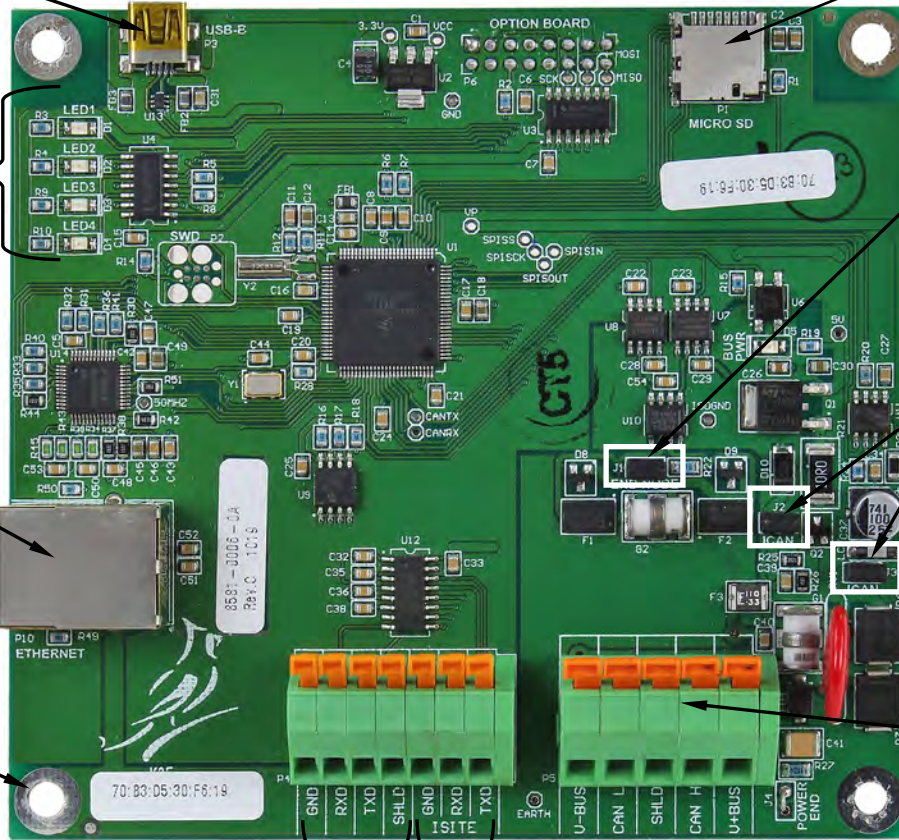

USB-B

This port is used to perform firmware updates to the 225DLC controller card.

Micro SD Card Slot

The Micro SD card slot is not used at this time.

LED 1-4

The LEDs are used for diagnostic purposes. For a complete explanation of their function, refer to the DIGITAL SCALE DIAGNOSTICS, Hardware Diagnostics section of this manual.

Ethernet Port

This port is used to connect the 225D to your network to send information to the cloud for iSite.

J1, End Node Jumper

Jumper J1 is the CAN bus END NODE jumper. **NOTE:** The J1 jumper must be installed for the 225D communications to the scale to operate.

J2, J3 ICAN Jumpers

These jumpers must be OFF (on one pin only or removed) when using the POWER-DLC to power the digital load cells in the scale. **NOTE:** If these jumpers are ON (installed), the 225D indicator is supplying the power to the digital load cells in the scale, and the POWER-DLC **cannot** be used.



IMPORTANT! The jumpers must be OFF (on one pin only or removed) when the POWER-DLC or an external power source, such as the MB-AC media box is used to power the digital load cells in the scale.

P5, Homerun Cable

The P5 terminal block is used to connect the homerun cable between the 225D indicator and the INDICATOR terminal block in the POWER-DLC. Refer to the table below for terminal connections.

Homerun Cable Connection to P5 Terminal Block

Board Label	Homerun Cable Wire Color	Wire Color if using a Load Cell Cable
SHLD	GRAY	BROWN
V+BUS	RED	WHITE
V-BUS	BLACK	BLUE
CAN H	WHITE	BLACK
CAN L	BLUE or LIGHT BLUE	GRAY

P4, Legacy Serial iSite

This portion of the P4 terminal block is used to connect to Legacy Serial iSite wiring when replacing or updating the indicator in an older system with a 225D.

P4, Future Use

This portion of the P4 terminal block is not used at this time. It is reserved for a future serial connection.

825D DIGITAL SCALE DIAGNOSTICS

On Screen Diagnostics

The On Screen Diagnostics messages are critical errors that alert the operator from the main screen of setup issues or hardware problems. These messages will be shown to the operator on the main weight screen in real-time when the error happens.

COMMUNICATION ERROR BETWEEN INDICATOR AND SCALE

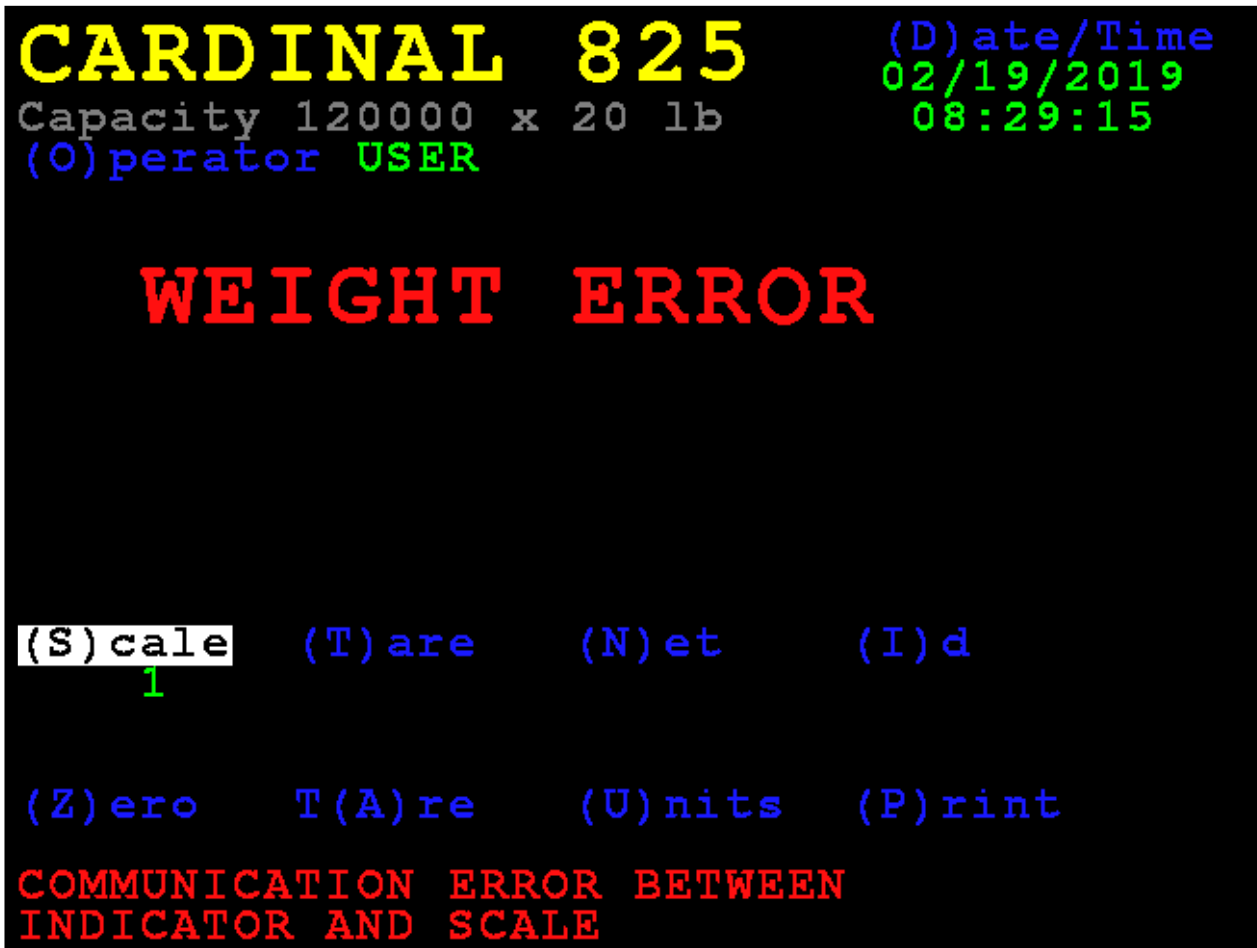

Probable Cause	Items to Check
The homerun cable is damaged or disconnected.	<ul style="list-style-type: none"> • Check that the cable is connected correctly. • Check cable for damage. • Use caution on the amount of insulation stripped for the connector. Otherwise, the center wires could short. Must be shorter than the center connector. • Check the connector for random strands of wire. • Verify that the connector is clear of debris.

COMMUNICATION ERROR BETWEEN LOAD CELLS X AND Y

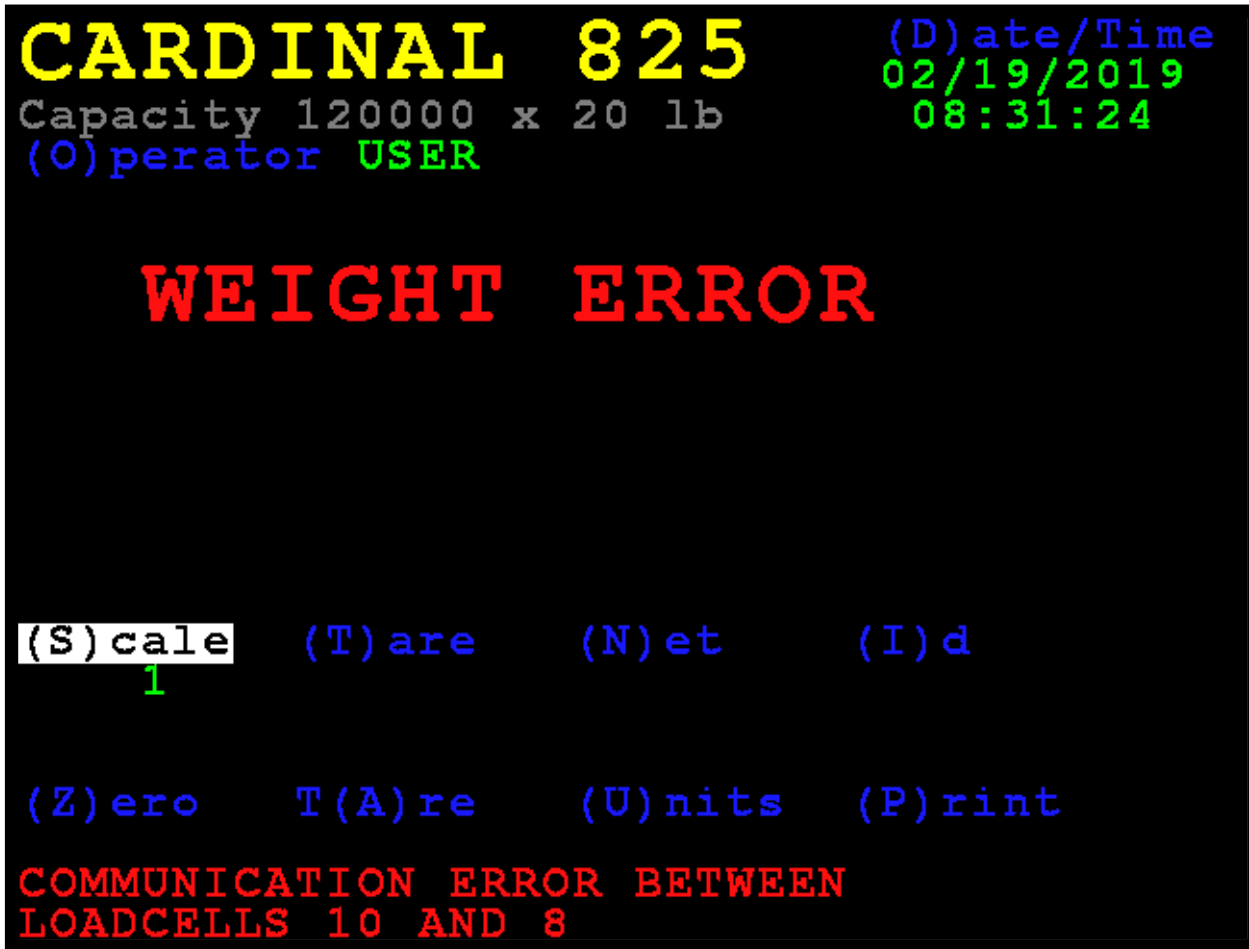

Probable Cause	Items to Check
There is a loss of communication between load cells.	<ul style="list-style-type: none"> • Check that the cable is connected correctly. • Check the cable for damage. • Verify that the connector is clear of debris. • Check the load cell COM ports on both load cells.

LOAD CELL X, Y, Z NOT RESPONDING

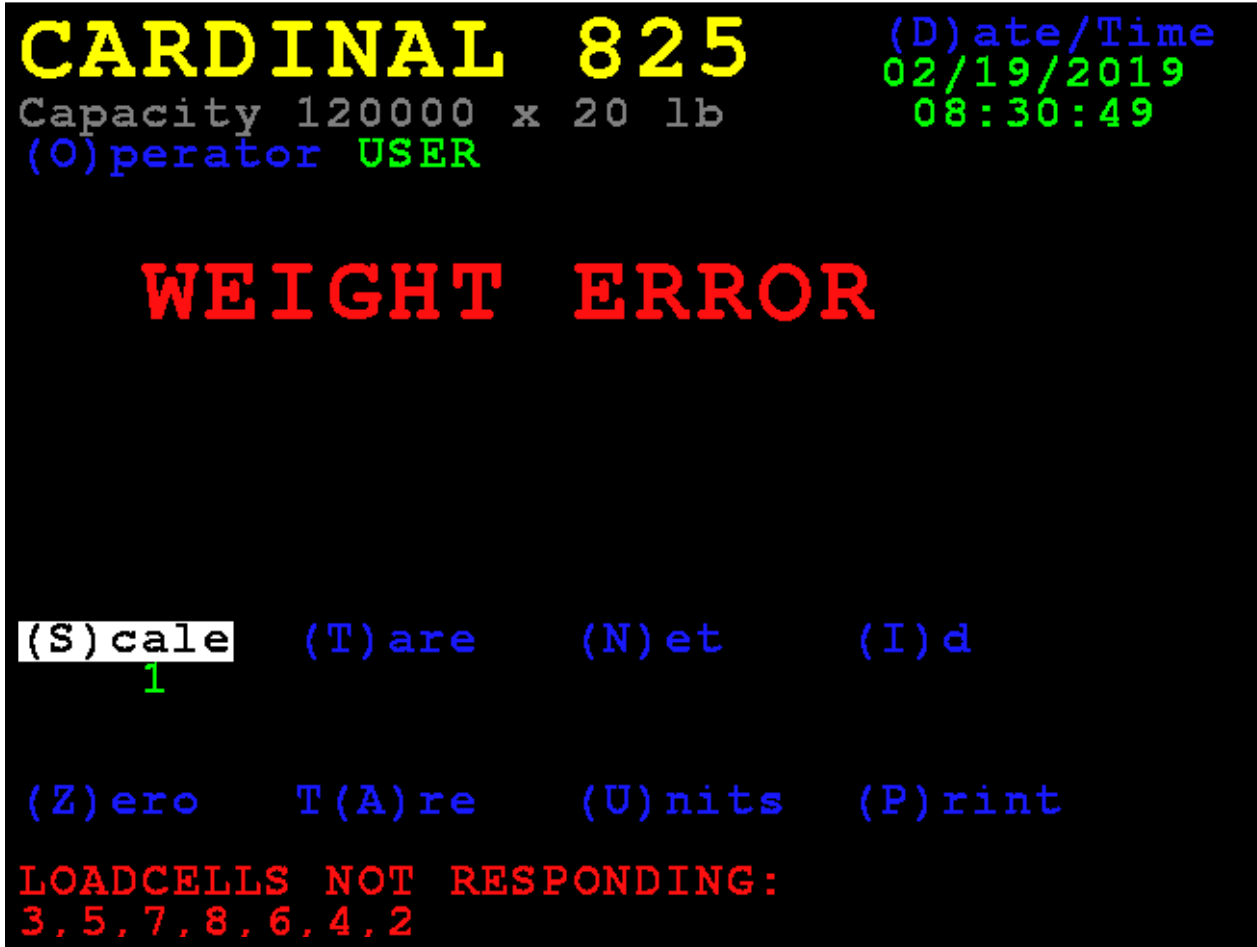

Probable Cause	Items to Check
The 825D cannot detect the exact communication problem with the unresponsive load cell.	<ul style="list-style-type: none"> • Check that the cable is connected correctly. • Check the cable for damage. • Verify that the connector is clear of debris. • There may be a potentially dead load cell.

LOW VOLTAGE DETECTED ON LOAD CELL X, Y, Z

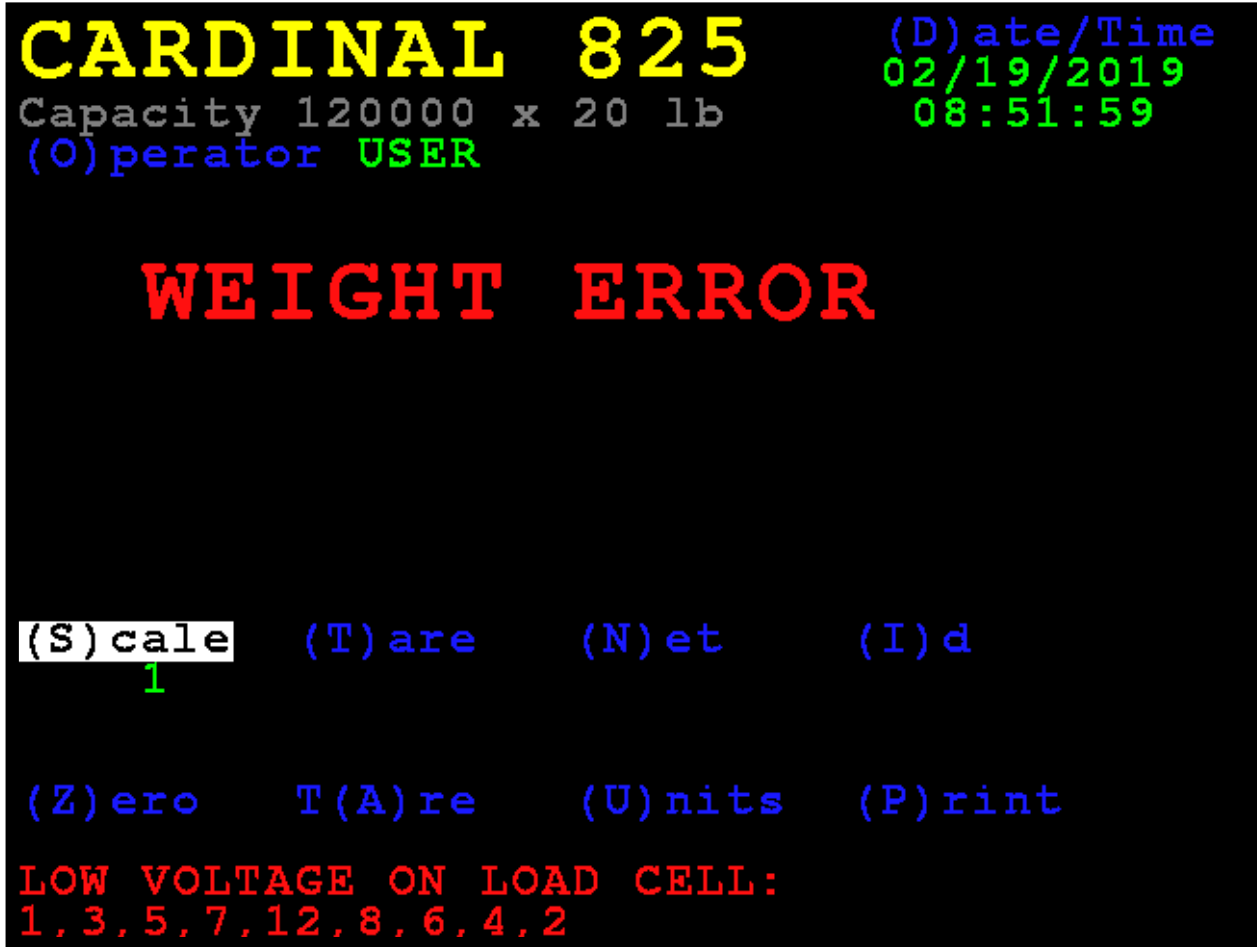

Probable Cause	Items to Check
Low power on a load cell. Load cells at the end of the CAN daisy chain are most susceptible to low voltage errors because of voltage drop along the cable.	<ul style="list-style-type: none"> • Too many load cells on the chain. • Check that the cable is connected correctly. • Check the cable for damage. • Verify that the connector is clear of debris. • Check the POWER-DLC.

Diagnostic Menu

The Diagnostic Menu is a set of diagnostic tools that give a technician more information about each load cell.

6. DLC Diagnostics

With the **Scale 1 - Calibration Options** screen displayed, press the **6** key or use the Navigation Keys to select (highlight) **6. DLC Diagnostics**, and then press the **ENTER** key.

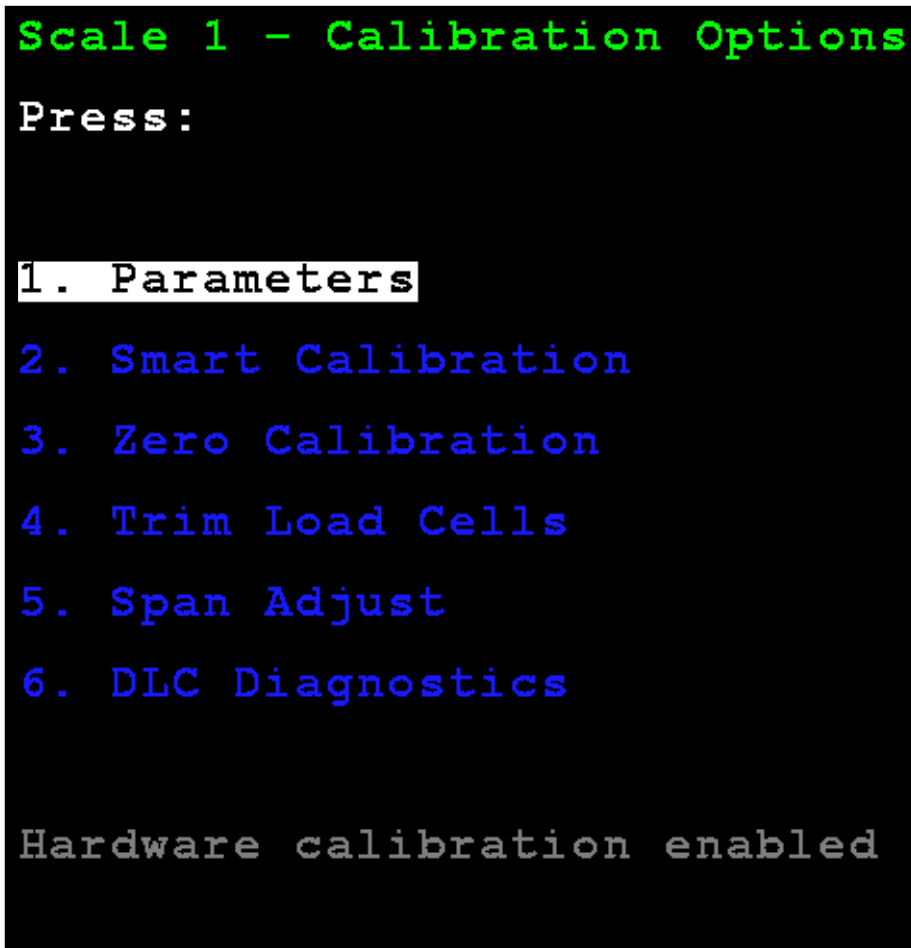

The display will change to show the **Digital Load Cell Diagnostics** screen.

LIVE LOAD CELL WEIGHTS

Use the Navigation Keys to scroll the display to show all cells.

Press the **W** key to jump to the **Load Cell Weights** screen from the other diagnostic screens.

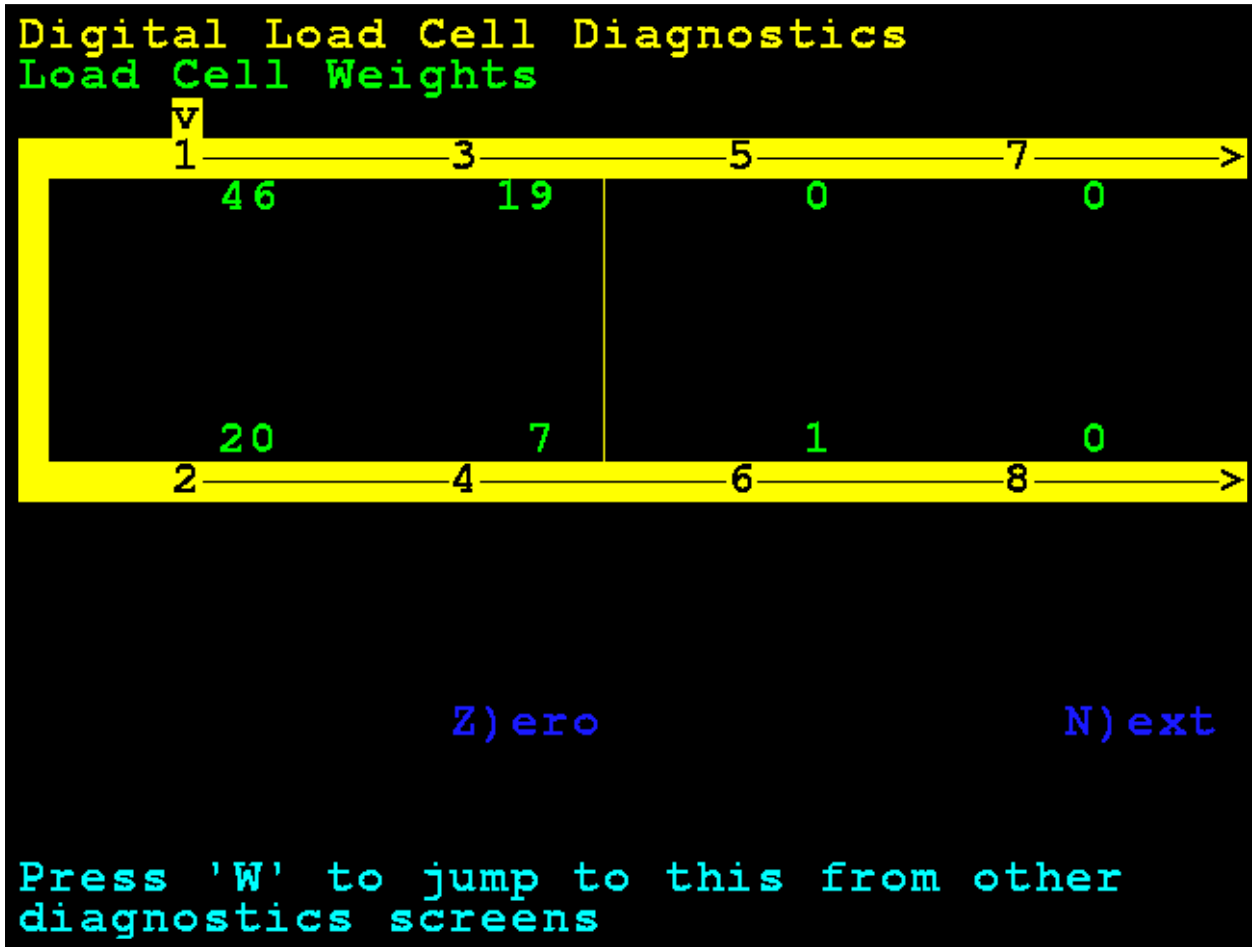

MINIMUM AND MAXIMUM WEIGHTS

Use the Navigation Keys to scroll the display to show all cells.

Press the **X** key to jump to the **Maximum / Minimum Weights** screen from the other diagnostic screens.

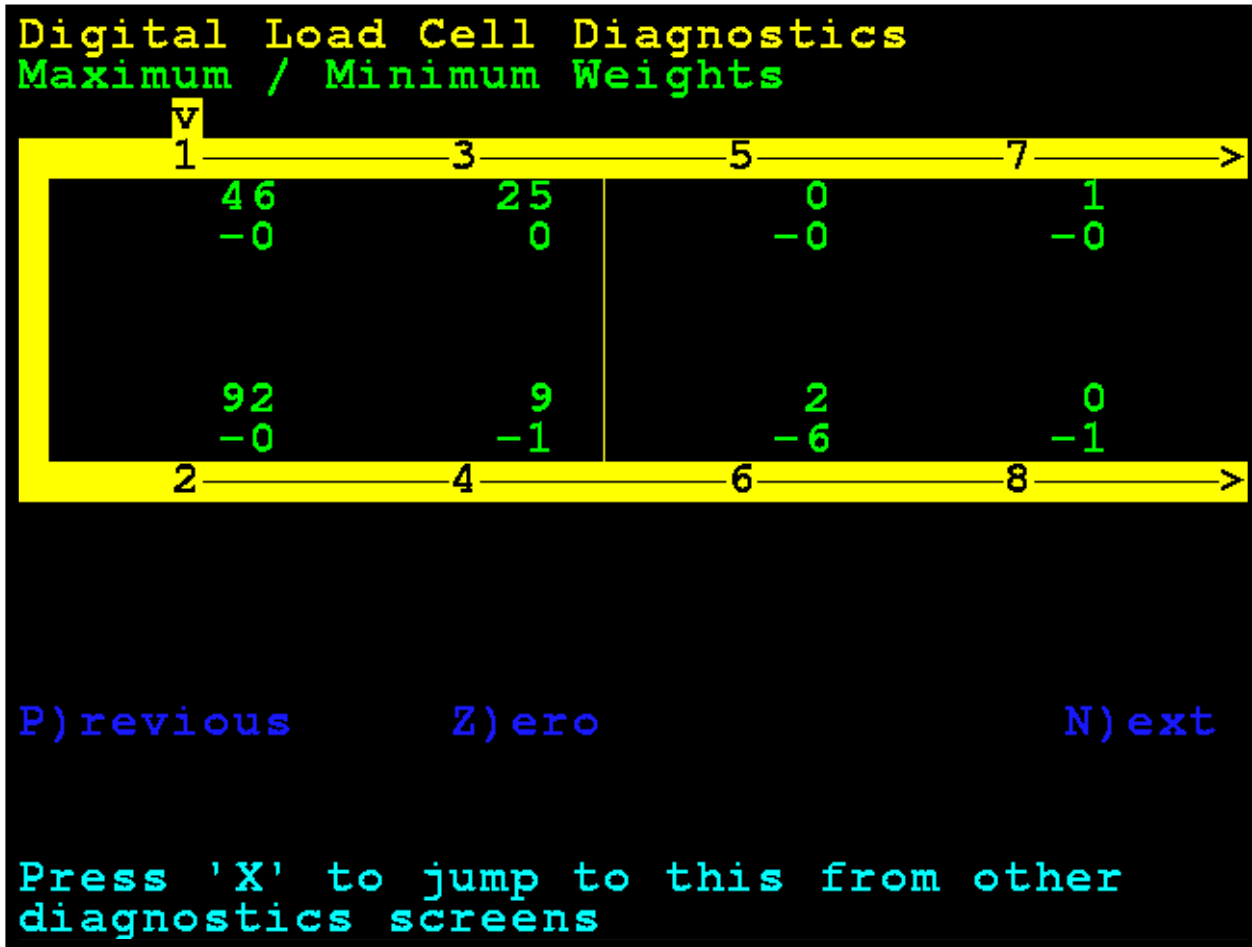

DEADLOAD SHIFT

This shows the live shift from the original calibrated deadload. An asterisk (*) indicates that the deadload shift has been exceeded. The scale must be empty for this to be valid.

Use the Navigation Keys to scroll the display to show all cells.

Press the **D** key to jump to the **Deadload Shift** screen from the other diagnostic screens.

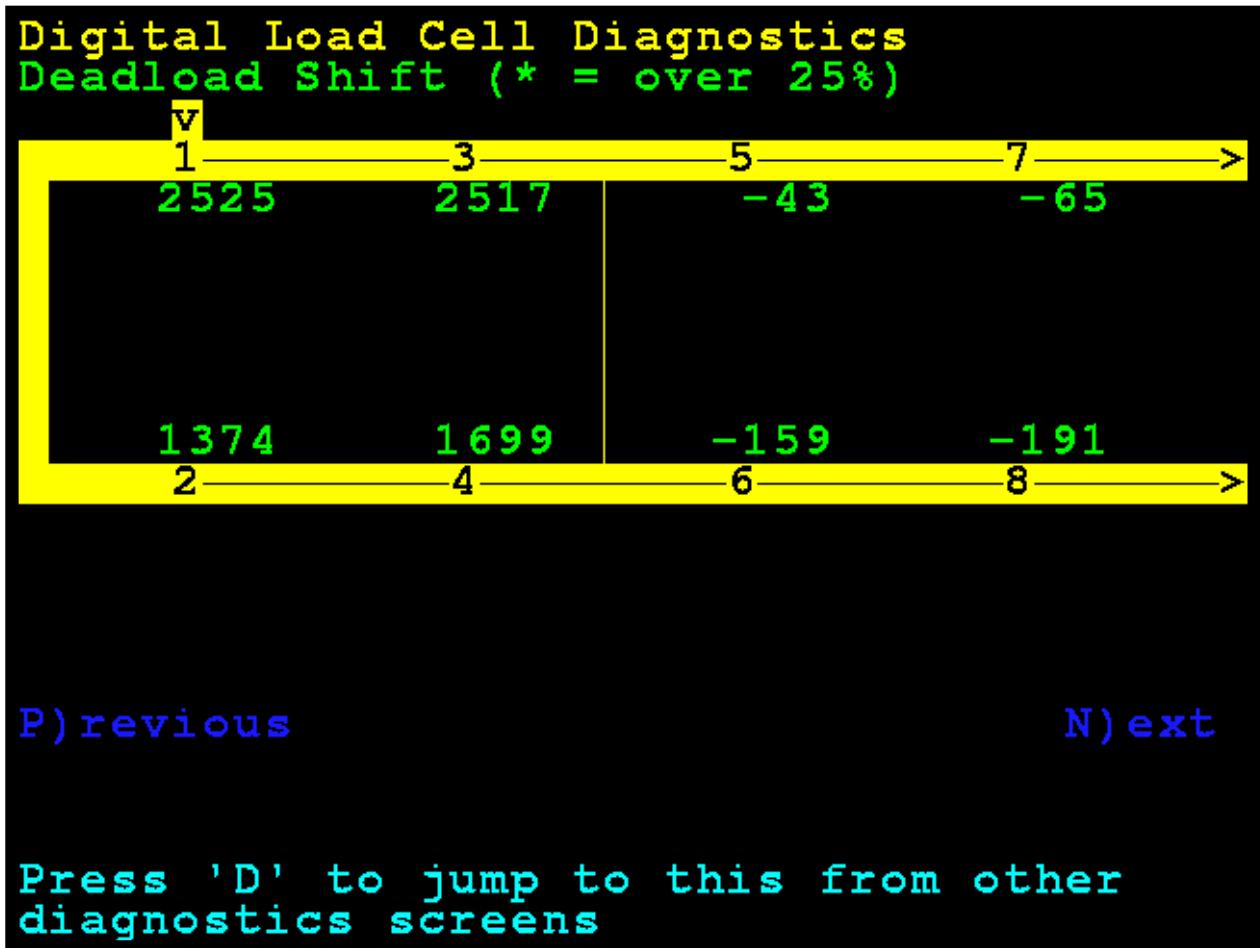

LOAD CELL IDS / SOFTWARE VERSIONS

Use the Navigation Keys to scroll the display to show all cells.

Press the **R** key to jump to the **Load Cell IDs / Software Versions** screen from the other diagnostic screens.

```
Digital Load Cell Diagnostics
Load Cell IDs / Software Versions
  v
  1-----3-----5-----7----->
1D6BFF0F 0B5B616F | 115DC621 0B2E2ECF
 1.0.14    1.0.14   | 1.0.14    1.0.14
15D64531 101BA5C1 | 049AED9F 0AF79DC1
 1.0.14    1.0.14   | 1.0.14    1.0.14
  2-----4-----6-----8----->

P)revious                                N)ext

Press 'R' to jump to this from other
diagnostics screens
```

LOAD CELL COMMUNICATION ERROR COUNTS

Use the Navigation Keys to scroll the display to show all cells.

Press the **E** key to jump to the **Load Cell Communication Error Counts** screen from the other diagnostic screens.

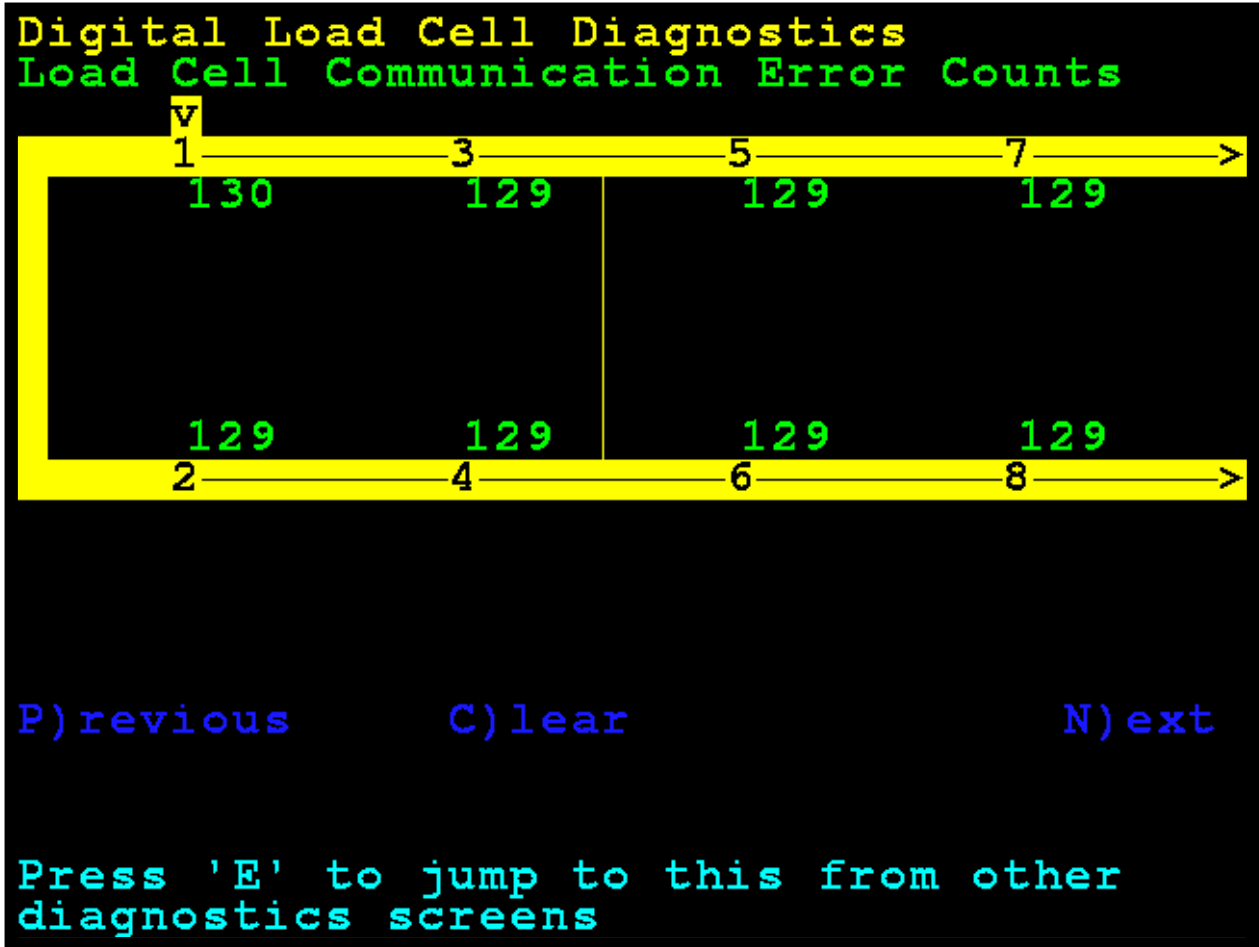

ZERO LOAD CELL COMMUNICATION ERROR COUNTS

Use the Navigation Keys to scroll the display to show all cells.

Press the **C** key to clear the Communication Error Counts.

Press the **E** key to jump to the **Load Cell Communication Error Counts** screen from the other diagnostic screens.

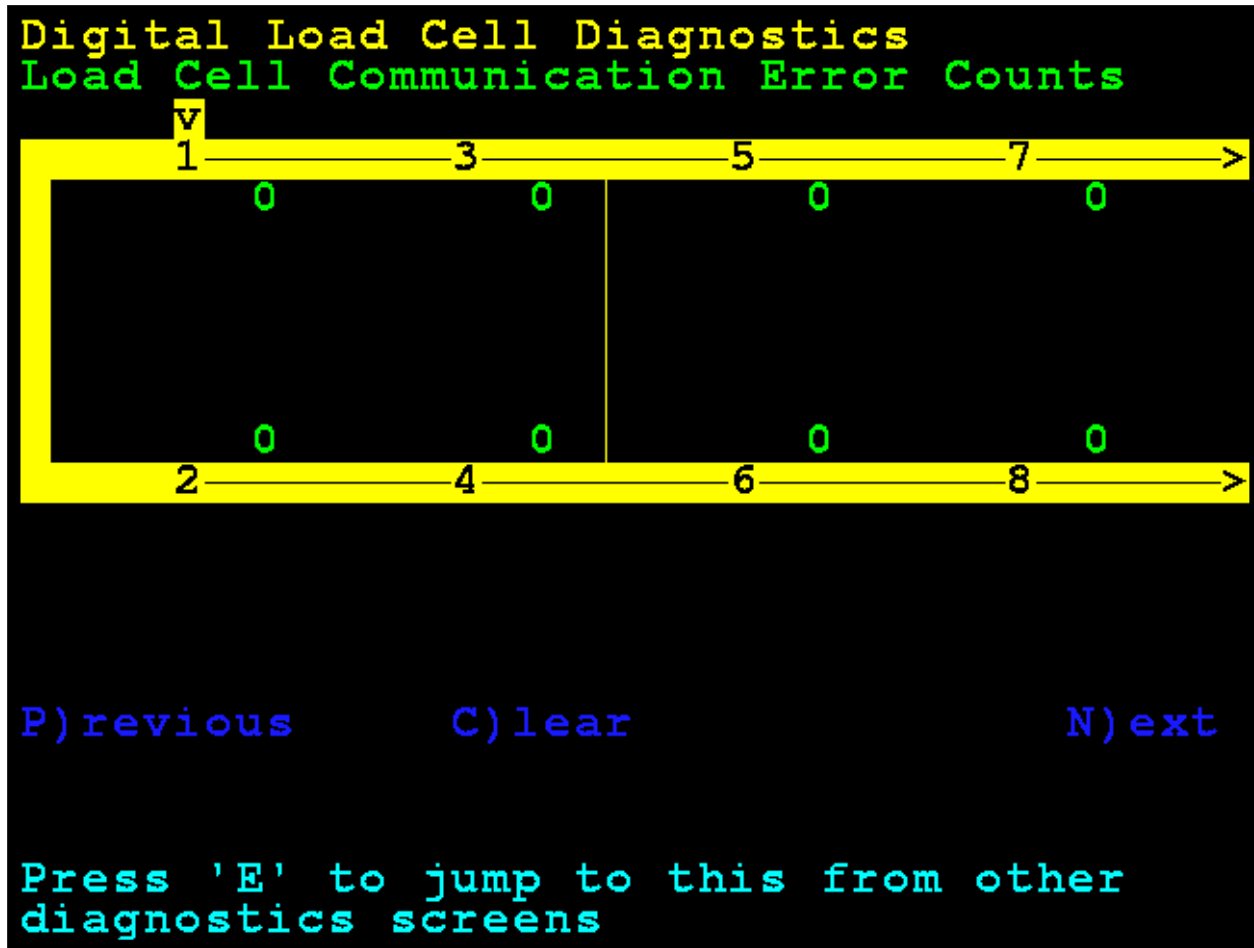

WEIGHT ERROR COUNTS

Weight Error Counts are analog errors that would normally indicate a bad cell.

Use the Navigation Keys to scroll the display to show all cells.

Press the **C** key to clear the Weight Error Counts.

Press the **G** key to jump to the **Weight Error Counts** screen from the other diagnostic screens.

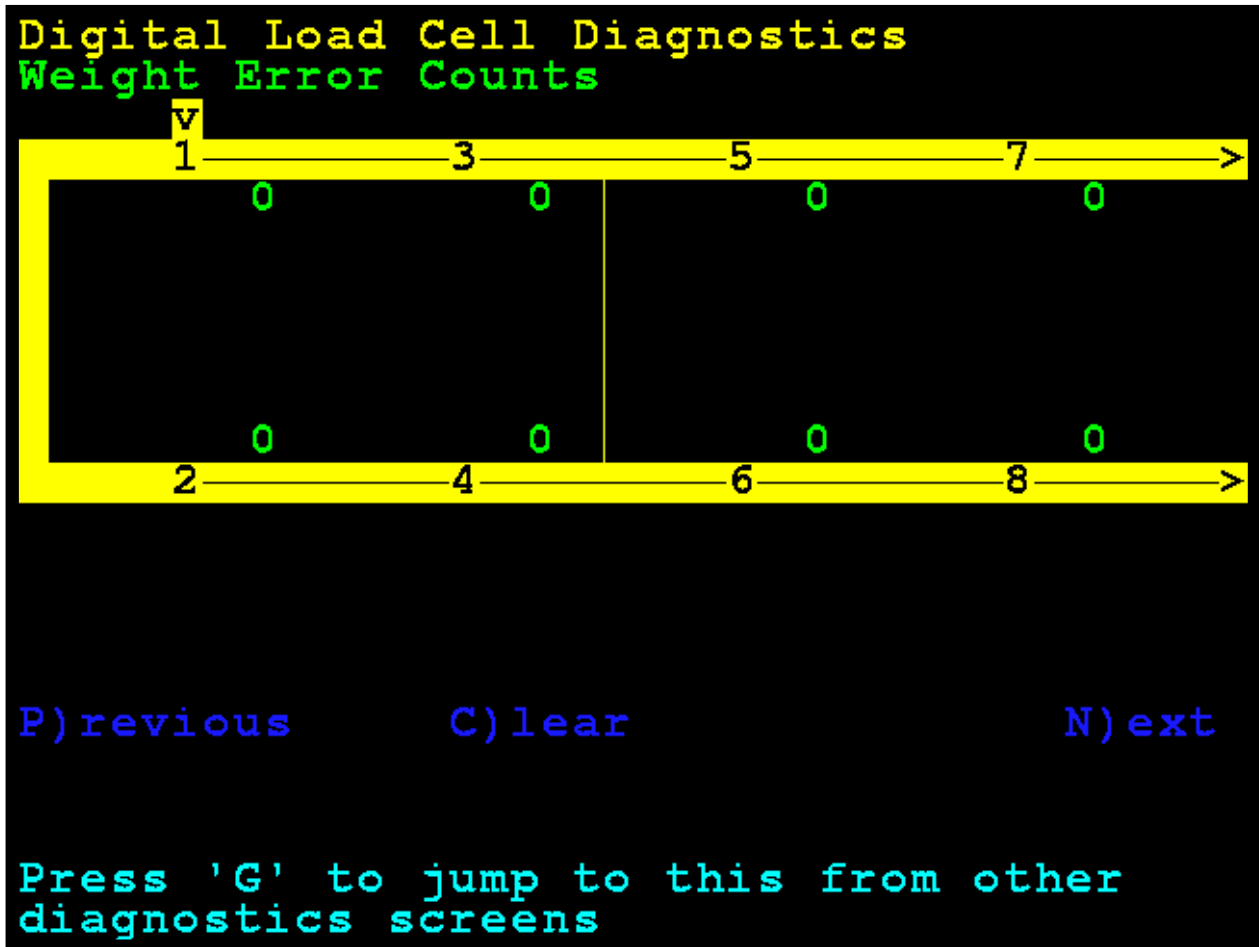

LOAD CELL TEMPERATURES

This is the temperature of the cells in Celsius.

Use the Navigation Keys to scroll the display to show all cells.

Press the **T** key to jump to the **Load Cell Temperatures** screen from the other diagnostic screens.

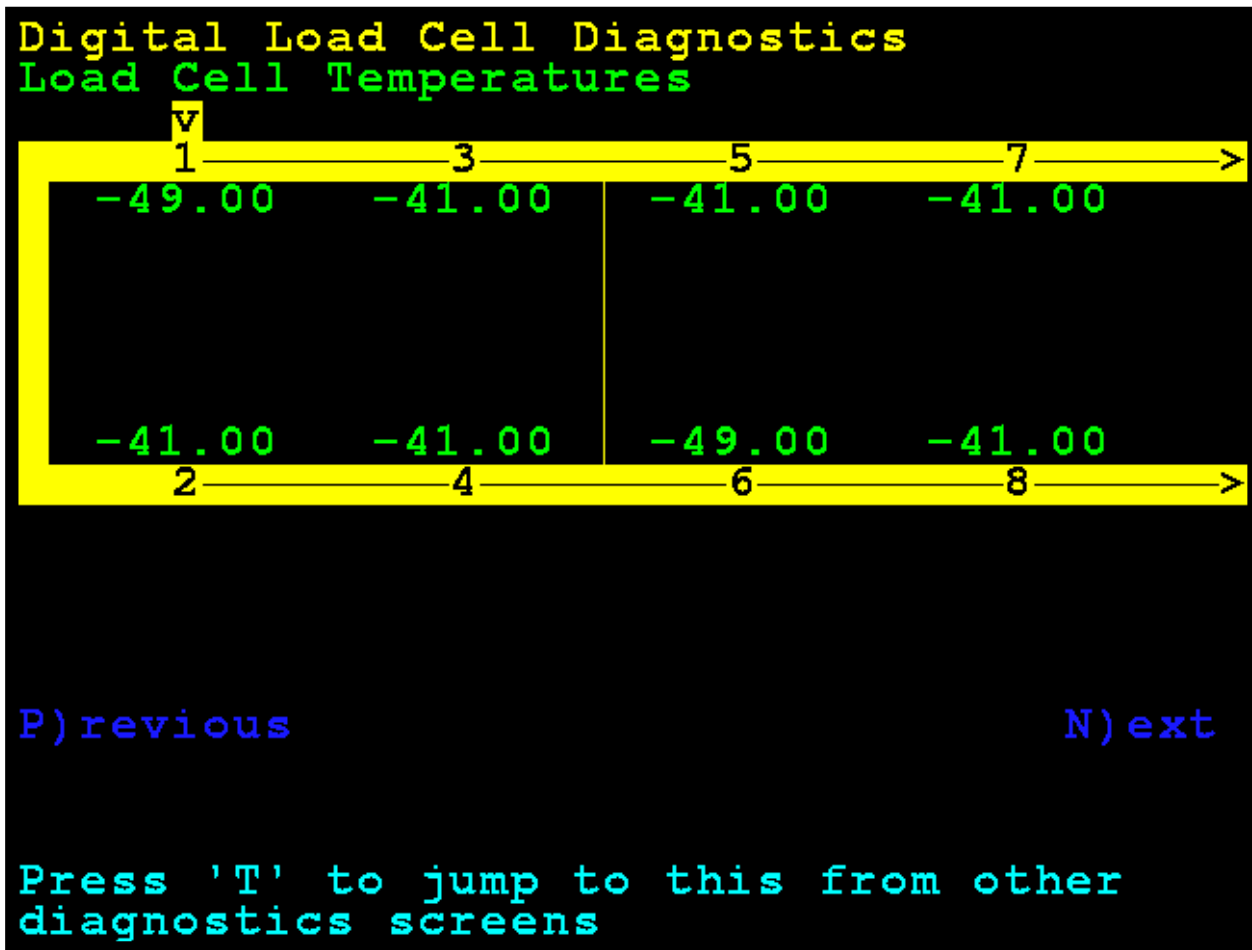

LOAD CELL MILLIVOLTS

Use the Navigation Keys to scroll the display to show all cells.

Press the **M** key to jump to the **Load Cell Millivolts** screen from the other diagnostic screens.

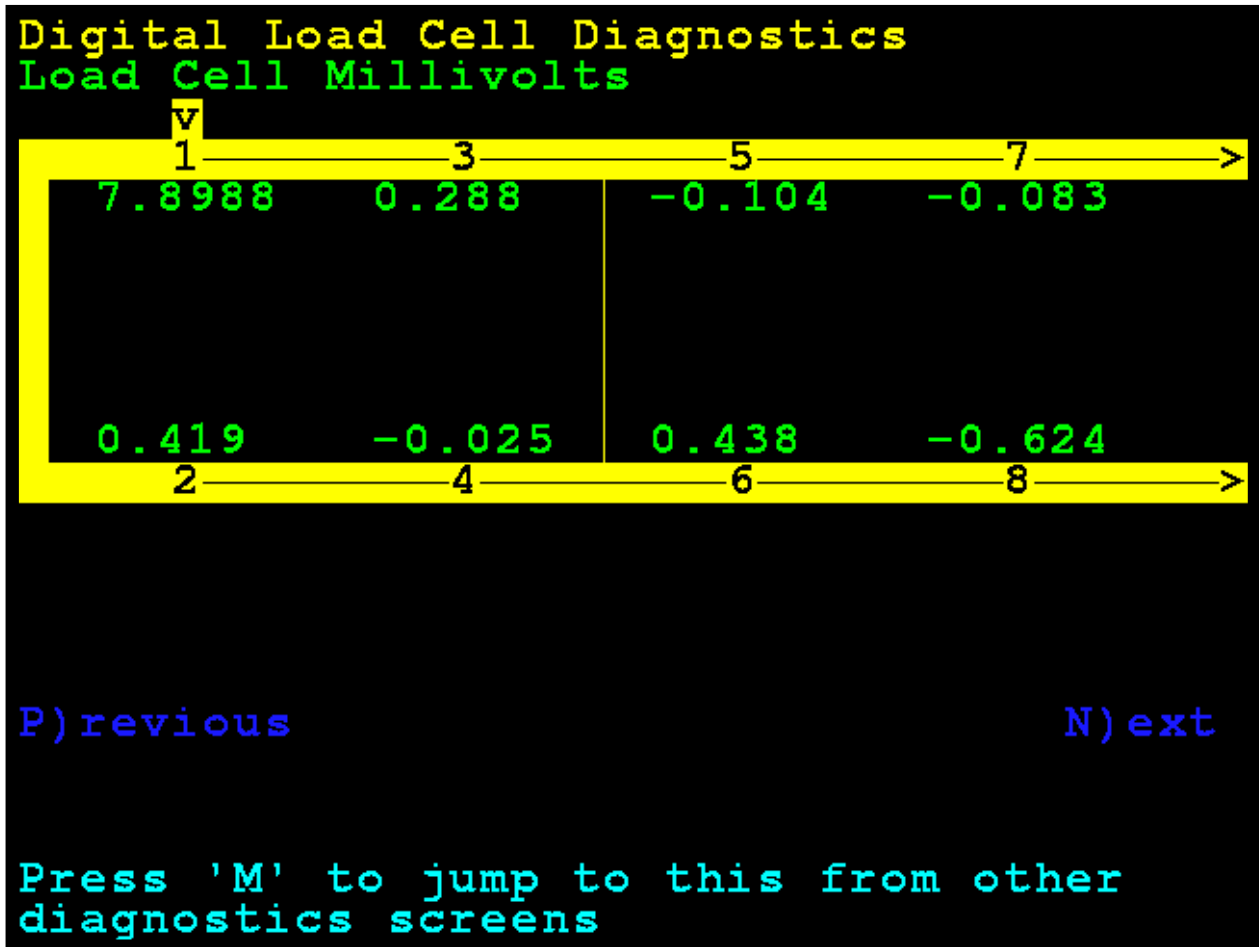

SUPPLY VOLTAGE – RAW COUNT / VOLTAGE

NOTE: An asterisk (*) indicates voltage determination is approximated based on the raw count value.

Use the Navigation Keys to scroll the display to show all cells.

Press the **V** key to jump to the **Supply Voltage – Raw Count / Voltage** screen from the other diagnostic screens.

Digital Load Cell Diagnostics
Supply Voltage - Raw Count / Voltage

1	3	5	7
1035 11.268	1028 11.018	1021 11.018	1028 11.080
1029 11.205	1025 11.143	1036 11.105*	1022 10.955

2 4 6 8

P)revious N)ext

Press 'V' to jump to this from other diagnostics screens

Hardware Diagnostics

The 825-DLC (Digital Load cell Controller) option card has four LEDs for diagnostic purposes.

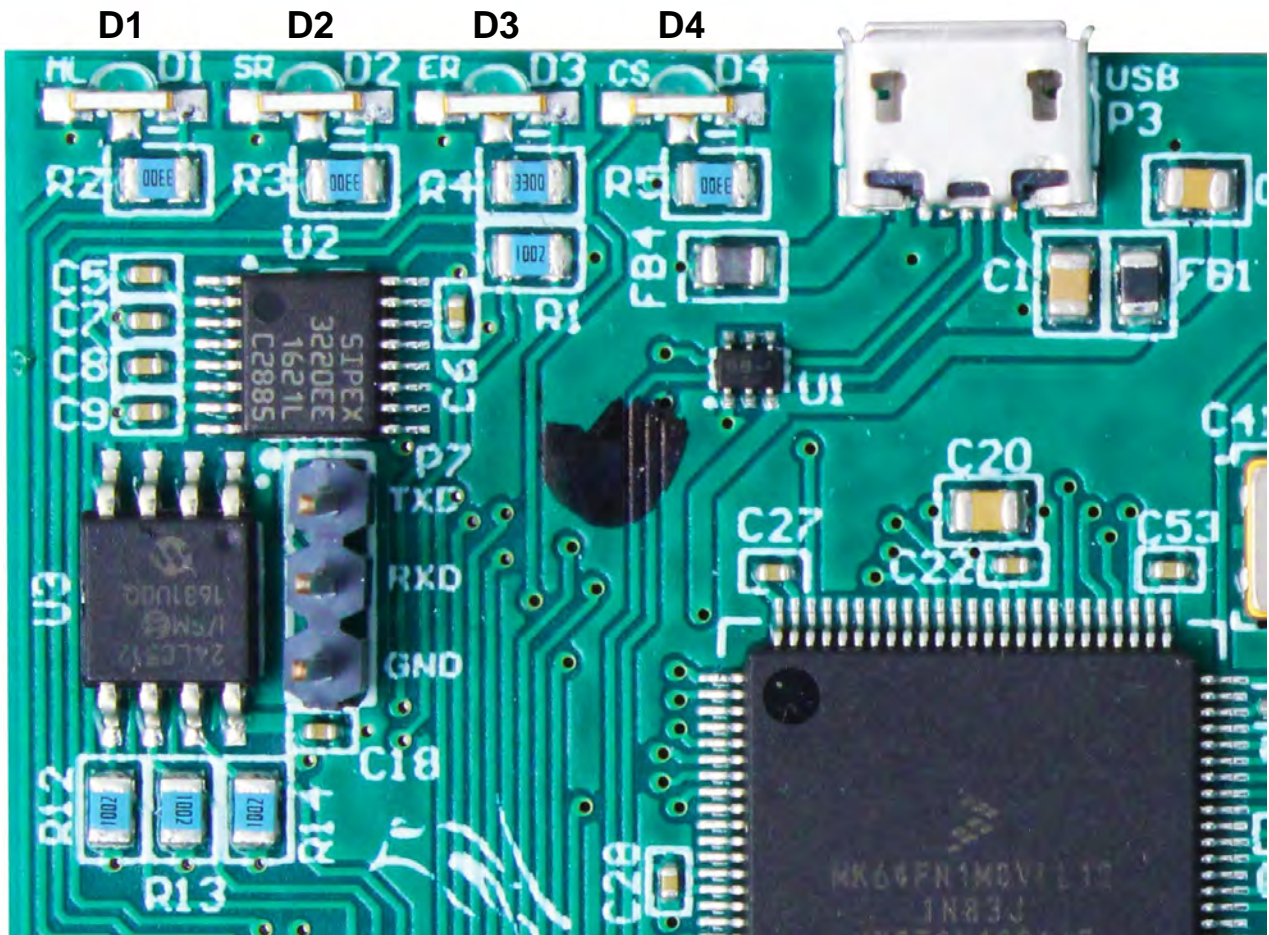

D1 – Blinking = Indicates the 825-DLC card is communicating with the 825D mainboard.

D2 – Blinking = Indicates the 825-DLC card is transmitting messages to the load cells.

D3 – Blinking = Indicates the 825-DLC card is receiving responses from all assigned load cells.

D4 – Blinking = Indicates 825-DLC card selected from the 825D mainboard.

DETECTING 825D BOARD REPLACEMENTS

The 825D will detect when a DLC controller or 825D mainboard has been replaced using checksums and unique board identification numbers. Based on several parameters, it can detect whether the option card was replaced, or the mainboard was replaced and then reconfigure the NEW card to the existing scale.

825D-DLC DIGITAL CONTROLLER CARD REPLACEMENT

If an option card is replaced, the 825D will boot up to this screen:

```
CARDINAL 825
Item          Version  01 cards  I[ ]
MnBd DLC      1.21.011 Slot Type  Version
Loader        1.10.013 1    DLC    1.00.001
OS/Std Apps  1.12.021

1. Application program
2. Standard indicator
3. Legal metrology information / Setup
4. Digital Scale Diagnostics
NEW CARD FOUND!
WAS DIGITAL SCALE CARD REPLACED (Y/N)? N
```

The 825D will check whether the option card has been replaced, in order to reconfigure the new option card to the existing scale.

If the operator selects YES, then the 825D mainboard will upload the scale configuration to the controller, and the 825D will immediately be able to make weight again.

825D MAIN PCB REPLACEMENT

If an 825D main board is replaced, the 825D will boot up to this screen:

```
CARDINAL 825
Item          Version  01 cards  I[ ]
MnBd DLC      1.21.011 Slot Type  Version
Loader        1.10.013  1   DLC    1.00.001
OS/Std Apps   1.12.021

1. Application program
2. Standard indicator
3. Legal metrology information / Setup
4. Digital Scale Diagnostics
NEW CARD FOUND!
WAS MAINBOARD REPLACED (Y/N)? N
```

The system will also check whether the 825D’s mainboard has been replaced, so the scale configuration can be downloaded from the controller to the mainboard.

If the operator selects YES, then the scale configuration will be downloaded from the controller to the mainboard. Scale configuration includes the number of load cells, all load cell IDs, and individual load cell trim. The 825D indicator parameters will need to be entered manually (Interval, Decimal Point Position, Zero Tracking, Filtering, Print Settings, and Serial Settings).

NOTE: A dead load calibration will need to be performed (does not require test weights).

825DLC Digital Controller Card Replacement



CAUTION! OBSERVE THE PRECAUTIONS FOR HANDLING STATIC SENSITIVE DEVICES

1. Remove the 825D power cord from the wall outlet.
2. Remove the fourteen acorn nuts securing the rear panel to the main housing.
3. Lift the rear panel from the main housing, taking care not to stretch the cables and wires between the panel and main housing. Lay the rear panel on the workbench/table next to the indicator.
NOTE: You may need to loosen the gland connectors to allow enough slack in the cable and wires to avoid stretching them.
4. Remove the screw securing the 825-DLC card to the main PC board and then lift the 825-DLC straight up to remove it from the enclosure.
5. Disconnect the Homerun cable wires (and any other wires or cables) from the 825-DLC card.
6. On the new 825-DLC card, connect the Homerun cable wires (and any other wires or cables).
7. To install the new 825-DLC card, carefully align the card edge connector with the PCI Express Bus (PCIe) slot, and apply even downward pressure to the edge of the 825-DLC card.
8. Secure the 825-DLC card to the mainboard with the screw removed earlier.
9. Ensure that no cables or wires are exposed between the main housing and the rear panel, and then place the rear panel onto the main housing, and secure it using the fourteen acorn nuts removed in step 2.
10. Re-insert the 825D power cord into the wall outlet.
11. Press the **ON/OFF** key on the 825D keypad to turn it on.

12. The 825D will boot up to this screen:

```
CARDINAL 825
Item          Version  01 cards  I[ ]
MnBd DLC      1.21.011 Slot Type  Version
Loader        1.10.013  1   DLC    1.00.001
OS/Std Apps   1.12.021

1. Application program
2. Standard indicator
3. Legal metrology information / Setup
4. Digital Scale Diagnostics
NEW CARD FOUND!
WAS DIGITAL SCALE CARD REPLACED (Y/N)? N
```

13. The 825D will check whether the option card has been replaced, in order to reconfigure the new option card to the existing scale.

14. If the operator selects Y, then the 825D mainboard will upload the scale configuration to the new 825-DLC card, and the 825D will immediately be able to make weight again.

825-DLC Controller (Digital Scale) Card

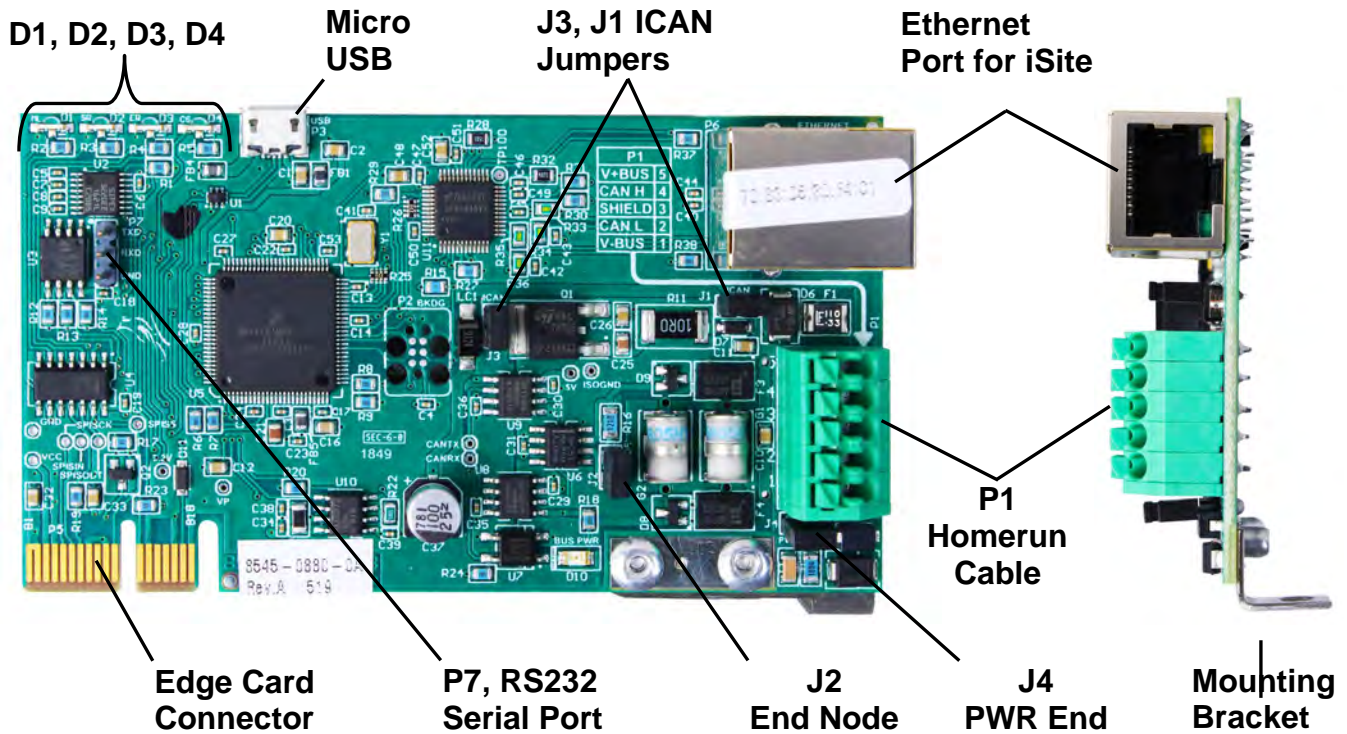

J2, End Node Jumper

Jumper J2 is the CAN bus END NODE jumper and should be ON (installed).

NOTE: The 825D is one end of the CAN bus connections and the J2 jumper must be installed for the 825D communications to the scale to operate.

J1, J3 ICAN Jumpers

These jumpers must be OFF (on one pin only or removed) when using the POWER-DLC to power the digital load cells in the scale. **NOTE:** If these jumpers are ON (installed), the 825D indicator is supplying the power to the digital load cells in the scale, and the POWER-DLC **cannot** be used.



IMPORTANT! The jumpers must be OFF (on one pin only or removed) when the POWER-DLC or an external power source, such as the MB-AC media box is used to power the digital load cells in the scale.

J4, PWR END

This jumper should be installed if the power to the digital load cells in the scale over the CAN bus cable (Homerun Cable) is provided by the 825D and not the POWER-DLC or an external power source such as the MB-AC media box.

P1, CAN Connection to Scale (Homerun Cable)

The P1 terminal block is used to connect the homerun cable between the 825D indicator and the INDICATOR terminal block in the POWER-DLC. Refer to the table below for terminal connections.

825DLC Controller Card P1 Terminal Connections

Board Label	Homerun Cable Wire Color	Wire Color if using a Load Cell Cable
SHLD	GRAY	BROWN
V+BUS	RED	WHITE
V-BUS	BLACK	BLUE
CAN H	WHITE	BLACK
CAN L	BLUE or LIGHT BLUE	GRAY

Micro USB

This connector is used to perform firmware updates to the 825-DLC controller card.

P6, Ethernet

This connector is used to connect the 825D to your network to send information to iSite.

P7, RS232 Serial Port

The P7 pins are used to connect to Legacy iCAN and for future connections.

LED 1-4

The LEDs are used for diagnostic purposes. For a complete explanation of their function, refer to the DIGITAL SCALE DIAGNOSTICS, Hardware Diagnostics section of this manual.

TROUBLESHOOTING GUIDE

It can happen sometimes; the scale installation has been completed, but the system just doesn't work, or it has been running smoothly and then a problem occurs. Before calling Cardinal Scale for assistance, there are a few things to check first that can be done to get the system back up and running. Remember, that there is a logical explanation for all problems, and for troubleshooting to be successful, it must be approached in a logical and rational manner.

The 225D and 825D indicators used with Cardinal Scale's DC Load Cell kit are equipped with software that indicates when an error in the operation takes place. Should a problem be detected, an error message will be displayed alerting the operator to that condition. The following is a list of some of the top system problems and recommended solutions to those problems.

DISPLAYED ERROR MESSAGES

REPLACE LOAD CELL X

SOLUTION:

- A. Using a NEST, test the load cell.
- B. If the load cell fails the test on the NEST, replace the indicated load cell.
- C. Verify calibration on the scale.

LOW VOLTAGE DETECTED CELL X

SOLUTION:

- A. Using a NEST, test the load cell.
- B. If the load cell fails the test on the NEST, replace the indicated load cell.
- C. If the load cell passes the test on the NEST, proceed with the following:
- D. Cut the end off of an extra load cell cable and strip back the wires to make a test cable.
- E. Ensure the scale is powered up.
- F. Remove the End Node (terminator) from the last load cell in the loop and connect the test cable to the port on the load cell where the End Node (terminator) was.
- G. Use a DVM to measure the DC voltage between the White wire (V+ Bus) and Blue wire (V- Bus). The voltage should be a minimum of 9 VDC. *Note that the voltage depends on the number of load cells in the loop.*
- H. If the system voltage is above 9 VDC, replace all the load cells indicated in the LOW VOLTAGE error message displayed.

LOW VOLTAGE DETECTED CELL X, Cont.

SOLUTION:

- I. If the system voltage is below 9 VDC, proceed as follows:
- J. First, remove the White (V+ Bus) and Blue (V- Bus) wires from the Homerun cable on the DLC Card, and then using a DVM, read the voltage on the connector. This should be a *minimum* of 14 VDC on the 225DLC (11.5 VDC on the 825-DLC). If the voltage is low, replace the DLC card. If it is a minimum of 14 VDC on the 225DLC (or 11.5 VDC on the 825-DLC) proceed as follows:
- K. Measure the current draw on the system. Remove the White (V+ Bus) wire from the DLC card. Put one lead of a DVM in the (V+ Bus) terminal on the DLC card. Attach the other lead of your DVM to the White (V+ Bus) wire going to the scale. Place your DVM in the Milliamps range. Note that on some DVM's, you may have to move the lead position from the normal position to the 0-400 milliamps range.
- L. On the 225D, you should read approximately 200 milliamps of current through an 8-load cell system (each load cell will pull approximately 25 milliamps). A 10-load cell system would read approximately 250 milliamps. Tolerance is +/- 15 milliamps.

On the 825D, you should read approximately 250 milliamps of current through an 8-load cell system (each load cell will pull approximately 30 milliamps). A 10-load cell system would read approximately 300 milliamps. Tolerance is +/- 15 milliamps.
- M. If the value is out of range, disconnect all load cell cables and read the current draw with no cells connected. Now, connect the cables to the load cells one at a time, and make sure that the current draw increases each time a load cell is connected.
 - On the 225D, the current draw should increase approximately 21 milliamps with each load cell connected.
 - On the 825D, the current draw should increase approximately 25 milliamps with each load cell connected.
If you find that connecting a load cell gives you a suspect reading, try it with a different cable. If the reading is still bad, replace the load cell.
- N. Proceed through testing the current draw on all cables and load cells, then retest the system voltage at the last load cell (End Node) in the loop. If the reading is still below 9 VDC replace the DLC card and check the voltage again.
- O. For a large number of cells and/or a long Homerun cable, an external 24 VDC power supply may be required. Consult the factory for recommendations.

CURRENT IS DRAW MORE THAN 150% OF CAPACITY

SOLUTION:

- A. Cut the end off of an extra load cell cable and strip back the wires to make a test cable.
- B. Ensure the scale is powered up.
- C. Remove the End Node (terminator) from the last load cell in the loop, and connect the test cable to the port on the load cell where the End Node (terminator) was.
- D. Use a DVM to measure the DC voltage between the White wire (V+ Bus) and Blue wire (V- Bus). The voltage should be a minimum of 9 VDC. *Note that the voltage depends on the number of load cells in the loop.*
- E. If the system voltage is below 9 VDC, proceed as follows:
 - E. Measure the current draw on the system. Remove the White (V+ Bus) wire from the DLC card. Put one lead of a DVM in the (V+ Bus) terminal on the DLC card. Attach the other lead of your DVM to the White (V+ Bus) wire going to the scale. Place your DVM in the Milliamps range. Note that on some DVM's, you may have to move the lead position from the normal position to the 0-400 milliamps range.
 - F. On the 225D, you should read approximately 200 milliamps of current through an 8-load cell system (each load cell will pull approximately 25 milliamps). A 10-load cell system would read approximately 250 milliamps. Tolerance is +/- 15 milliamps.

On the 825D, you should read approximately 250 milliamps of current through an 8-load cell system (each load cell will pull approximately 30 milliamps). A 10-load cell system would read approximately 300 milliamps. Tolerance is +/- 15 milliamps.
 - G. If the value is out of range, disconnect all load cell cables and read the current draw with no cells connected. Now, connect the cables to the load cells one at a time, and make sure that the current draw increases each time a load cell is connected.
 - On the 225D, the current draw should increase approximately 21 milliamps with each load cell connected.
 - On the 825D, the current draw should increase approximately 25 milliamps with each load cell connected.
- If you find that connecting a load cell gives you a suspect reading, try it with a different cable. If the reading is still bad, replace the load cell.
- H. Proceed through testing the current draw on all cables and load cells, then retest the system voltage at the last cell (End Node) in the loop. If the reading is still below 9 VDC replace the DLC card and check the voltage again.

LOAD CELL X NOT RESPONDING

SOLUTION:

- A. Using a hydraulic jack, raise the weighbridge at the load cell location to remove the deadload from the load cell.
- B. Using a NEST, run the automated load cell test.
- C. If the load cell fails the NEST test, replace the load cell.
- D. If the load cell passes the NEST test, proceed to the error message,

COMMUNICATIONS ERROR BETWEEN INDICATOR AND SCALE

- E. If multiple load cells are not responding, confirm that the Start Node and End Node load cells in the loop match the settings in the indicator.

COMMUNICATIONS ERROR BETWEEN INDICATOR AND SCALE

SOLUTION:

- A. Remove power to the indicator and leave it off for a few minutes. Apply power to the indicator. If the indicator displays weight, proceed with normal operations. Otherwise, follow the next steps to determine the problem.

NOTE: If the indicator works for a few minutes, then the error message appears again, install a ground wire between the 225D (825D) and the scale ground rod.

- B. Go to the Load Cell Assignment screen on the indicator and write down all of the load cell IDs and their corresponding scale locations (NOT the location in the data loop).
- C. If a Cardinal Digital Load Cell Simulator is available, remove the Homerun cable from the first load cell in the loop and attach it to the simulator.
- D. Go to the Scale Setup screen and change the number of load cells to “1” and assign the simulator ID to that load cell position. The 225D (825D) should display CELL RESPONDED. If NO CELL RESPONSE is displayed, return to the Calibration screen, and perform a **ZERO CAL**. Return to the Weight screen, and cycle power (turn off, then back on) to save the settings. The 225D (825D) should display weight when the slide on the simulator is moved.
- E. If the scale will not function with the simulator, go to the Calibration screen, select SmartCal, and attempt to calibrate the scale.
- F. If the scale will not calibrate with the simulator, using a short test cable, connect the simulator directly to the 225DLC (825-DLC) card, bypassing the Homerun cable. If the 225D (825D) will not recognize and communicate with the simulator, the 225DLC (825-DLC) card is bad and will need to be replaced.
- G. If the scale will calibrate with the simulator connected directly to the 225DLC (825-DLC) card, use a NEST and perform the cable test on the Homerun cable.

COMMUNICATIONS ERROR BETWEEN INDICATOR AND SCALE, Cont.

SOLUTION:

- H. If a NEST is not available, proceed with the following instructions to check the Homerun cable for shorts:
1. Disconnect the Homerun cable from the load cell (Start Node).
 2. Starting with one wire, check the resistance between it and each of the other wires one at a time. With a DVM this should always read "OL" to indicate there is no current flow between that pair of wires.
 3. After checking the first wire take the next wire and check it for shorts to the remaining three wires.
 4. Continue this procedure until all wires are tested for shorts to all other wires.
- I. If the Homerun cable, 225DLC (825-DLC), and 225D (825D) check good with the simulator, we need to test each load cell in the loop by starting with the first load cell.
- Go to the Scale Setup screen and enter "1 Loadcell" to select that cell, assign it to scale one, and enter the ID for the load cell you are connected to. Press ENTER. The 225D (825D) should display CELL RESPONDED, indicating that the load cell is communicating and good. If NO CELL RESPONSE is displayed, return to the Calibration screen, and perform a **ZERO CAL**. Return to the Weight screen, and cycle power (turn off, then back on) to save the settings. If the 225D (825D) displays weight, zero the indicator, then stand on the deck over the load cell to confirm the operation. If the load cell fails to respond, replace the load cell.
- J. Next, connect the next load cell in the loop. Go to the Scale Setup screen and enter "Number of Cells 2". Enter the ID for the second load cell. Press ENTER. The 225D (825D) should display CELL RESPONDED, indicating that the second load cell is communicating and good. If NO CELL RESPONSE is displayed, return to the Calibration screen, and perform a **ZERO CAL**. Return to the Weight screen, and cycle power (turn off, then back on) to save the settings. If the 225D (825D) displays weight, zero the indicator, then stand on the deck over the second load cell to confirm the operation. If the load cell fails to respond, replace the load cell.
- K. Continue adding load cells one at a time until you have a load cell that will not communicate. When that occurs, first replace the cable connecting the last good load cell to the load cell you are testing, to see if a different cable resolves the failure. If it does, proceed to the next load cell to test. If a different cable does not correct the failure, place a new load cell in the current position and input that load cell ID, and see if it responds. If the new load cell does not respond, place the new load cell in the previous position to see if it will communicate through it.
- L. Continue this process until all load cells are working and making weight. After all load cells are communicating and making weight, go back into the Load Cell Setup and enter the load cell IDs in their correct scale position. Cycle power (turn off, then back on) to save the settings, perform a **ZERO CAL**, and then verify calibration.

LOAD CELL X HAS NO ADDRESS

SOLUTION:

- A. Go to the Scale Setup screen and enter the load cell ID in the correct scale location.

COMMUNICATION ERROR BETWEEN LOADCELLS X AND Y

SOLUTION:

- A. Use the NEST to test the suspect load cell cable for defects.
- B. If the load cell cable tests good, use the NEST to test the two connecting load cells.
- C. If a NEST is not available, replace the suspect load cell cable with a new load cell cable and confirm the operation.
- D. If after replacing the load cell cable, the error still exists, replace the two connecting load cells (one at a time) to confirm the operation.

SCALE WILL NOT RETURN TO ZERO

SOLUTION:

- A. After ensuring the scale deck is clear of any buildup or debris, enter DIAGNOSTICS.
- B. The first screen displays the actual deadload that is on each load cell. If these values look correct, push the ZERO key to get a zero reading for each load cell.
- C. Make multiple passes with a loaded truck and observe which (if any) load cells do not return to zero. Small errors are normal as the deck may not return to exactly its previous position.
- D. If a load cell is not returning to zero, jack up the bridge at that load cell location and check for broken pivot plates, balls, or the hardened cup.
- E. Check for clearance from the corner stand to the main beam flanges. If a stand is not centered, and rubbing the bridge, it will cause zero errors.

SCALE IS UNSTABLE

SOLUTION:

- A. Go to the second diagnostics screen MINIMUM/MAXIMUM WEIGHTS and press ZERO.
- B. Observe the change in output of the load cells for 10-15 minutes to identify a drifting load cell.

LOAD CELL OR SCALE COMMUNICATIONS PROBLEMS

SOLUTION:

- A. Go to the Diagnostics screen LOAD CELL COMMUNICATIONS ERRORS and observe the historical error counters for each load cell.
- B. Record these numbers.
- C. Press EXIT(?) to zero the counters on the 225D.

For the 825D, press C)lear to zero the counters.

NOTE: Some number of communications errors are normal, however, they should all be approximately the same.

PARTS IDENTIFICATION



6010-00001
2" (51 mm) Grade 1000 Ball
Bearing, 52100 Chrome



0330-0048-08
Bearing Cup Receiver

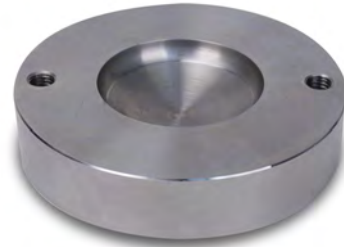

0330-0050-08
Lower Receiver Bearing Cup



0331-0107-0A
axis® Load Cell Stand
Weldment for SCBD



SCBD75 / SCDB100
75K or 100K Digital Double
End Shear Beam Load Cell



0330-0125-18
Load Cell End Pivot Plate
(Requires 2 per load cell)



0330-0065-08
15' (4.6 m) Load Cell
Interconnect Cable



0330-0066-08
27' (8.2 m) Load Cell
Interconnect Cable



0330-0443-08
37' (11.3 m) Load Cell
Interconnect Cable

PARTS IDENTIFICATION, CONT.



0330-0067-08
Load Cell End Terminator



6610-1258
5-Pin Spring Cage Type
Homerun Cable Connector



POWER-DLC
24VDC Power Supply for Digital
Load Cell Systems

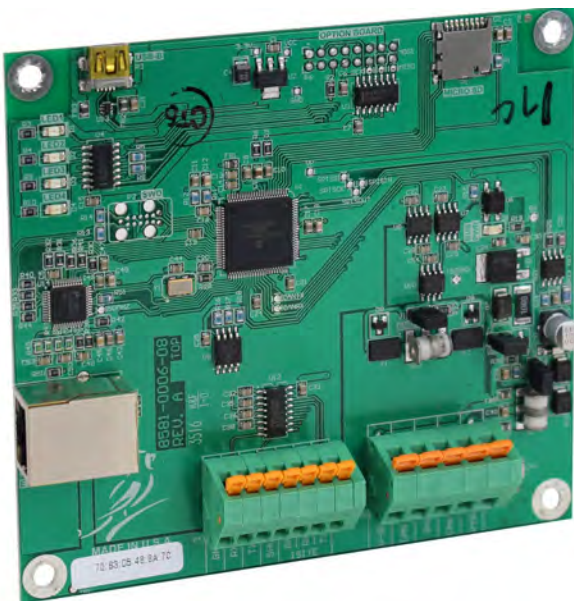

225-DLC
225DLC Digital Load Cell Controller



825-DLC
825DLC Digital Load Cell Controller

STATEMENT OF LIMITED WARRANTY

WARRANTY TERMS

Cardinal Scale Manufacturing Company warrants the equipment we manufacture against defects in material and workmanship. The length and terms and conditions of these warranties vary with the type of product and are summarized below:

PRODUCT TYPE	TERM	MATERIAL AND WORKMANSHIP	LIGHTNING DAMAGE See note 9	WATER DAMAGE See note 7	CORROSION See note 4	ON-SITE LABOR	LIMITATIONS AND REQUIREMENTS
WEIGHT INDICATORS	90 DAY REPLACEMENT ----- 1 YEAR PARTS	YES	YES	YES	YES	NO	1, 2, 3, 5, 6 A, B, C, D
LOAD CELLS (Excluding Hydraulic)	1 YEAR	YES	YES	YES	YES	NO	1, 2, 3, 5, 6 A, B, C, D
HYDRAULIC LOAD CELLS (When purchased with Guardian Vehicle Scale)	LIFE	YES	YES	YES	YES	90 DAYS	1, 5, 6, 8 A, B, C, D
HYDRAULIC LOAD CELLS (When purchased separately)	10 YEARS	YES	YES	YES	YES	NO	1, 5, 6, 8, 9 A, B, C, D
VEHICLE SCALE (Deck and Below Excl. PSC Series)	5 YEARS	YES	YES	YES	YES	90 DAYS	1, 2, 3, 5, 6 A, B, C, D, E
PSC and LSC SCALE STRUCTURES (Deck and Below)	3 YEARS	YES	YES	YES	YES	90 DAYS	1, 2, 3, 5, 6, 11 A, B, C, D
GUARDIAN FLOOR SCALES	10 YEARS	YES	YES	YES	YES	NO	1, 2, 3, 5, 6, 9, 10 A, B, C, D
ALL OTHER CARDINAL PRODUCTS	1 YEAR	YES	YES	YES	YES	NO	1, 2, 5, 6 A, B, C, D, E
REPLACEMENT PARTS	90 DAYS	YES	YES	YES	YES	NO	1, 2, 4, 5, 6 A, B, C, D
IN-MOTION VEHICLE SCALES	1 YEAR	YES	YES	YES	YES	90 DAYS	1, 2, 5, 6 A, B, C, D
SOFTWARE	90 DAYS	YES	N/A	N/A	N/A	NO	1, 6 B, C, D



Ph. (800) 441-4237
 E-mail: cardinal@cardet.com
 203 E. Daugherty
 Webb City, MO 64870

06/13
 Printed in USA
 315-WARRANTY-CAR-K

APPLICABLE LIMITATIONS AND REQUIREMENTS

1. This warranty applies only to the original purchaser. The warranty does not apply to equipment that has been tampered with, defaced, damaged, or had repairs or modifications not authorized by Cardinal or has had the serial number altered, defaced or removed.
2. This warranty is not applicable to equipment that has not been grounded in accordance with Cardinal's recommendations.
3. This equipment must be installed and continuously maintained by an authorized Cardinal dealer.
4. Applies only to components constructed from stainless steel.
5. This warranty does not apply to equipment damaged in transit. Claims for such damage must be made with the responsible freight carrier in accordance with freight carrier regulations.
6. Warranty term begins with date of shipment from Cardinal.
7. Only if device is rated NEMA 4 or better or IP equivalent.
8. Lifetime warranty applies to damages resulting from water, lightning, and voltage transients and applies only to the hydraulic load cell structure itself (does not include pressure transducers, rubber seals, o-rings, and associated wiring).
9. 10 Year prorated warranty on hydraulic load cells.
10. 1 Year warranty for scale structure.
11. PSC models' warranty coverage applies only to agricultural installations on farms up to 3,000 acres (LSC models not limited in this manner).
12. Load cell kits MUST be installed in accordance with Cardinal Scale instructions. Failure to follow these instructions will void the warranty.

EXCLUSIONS

- A.) This warranty does not include replacement of consumable or expendable parts. The warranty does not apply to any item that has been damaged due to unusual wear, abuse, improper line voltage, overloading, theft, fire, water, prolonged storage or exposure while in purchaser's possession or acts of God unless otherwise stated herein.
- B.) This warranty does not apply to peripheral equipment not manufactured by Cardinal. This equipment will normally be covered by the equipment manufacturer's warranty.
- C.) This warranty sets forth the extent of our liability for breach of any warranty or deficiency in connection with the sale or use of our product. Cardinal will not be liable for consequential damages of any nature, including but not limited to loss of profit, delays or expenses, whether based on tort or contract. Cardinal reserves the right to incorporate improvements in material and design without notice and is not obligated to incorporate said improvements in equipment previously manufactured.
- D.) This warranty is in lieu of all other warranties expressed or implied including any warranty that extends beyond the description of the product including any warranty of merchantability or fitness for a particular purpose. This warranty covers only those Cardinal products installed in the forty-eight contiguous United States and Canada.
- E.) This warranty does not cover paint coatings due to the variety of environmental conditions.
- F.) Do not cut load cell cables on load cells returned for credit or warranty replacement. Cutting the cable will void the warranty.
- G.) Software is warranted only for performance of the functions listed in the software manual and/or the Cardinal proposal.
- H.) The software warranty does not cover hardware. Warranties on hardware are provided from the hardware vendor only.
- I.) The software warranty does not cover interfacing issues to non-Cardinal supplied hardware.
- J.) The software warranty does not include automatic software upgrades unless purchased separately.



Ph. (800) 441-4237
E-mail: cardinal@cardet.com
203 E. Daugherty
Webb City, MO 64870

06/13
Printed in USA
315-WARRANTY-CAR-K

Cardinal Scale Mfg. Co.

102 E. Daugherty, Webb City, MO 64870 USA

Ph: 417-673-4631 or 1-800-641-2008

Fax: 417-673-2153

www.cardinalscale.com

Technical Support: 1-866-254-8261

E-mail: tech@cardet.com

Printed in USA

0330-0651-0M Rev C 05/22